



DRUM TRIGGER MODULE

DTXPRESS

Owner's Manual

YAMAHA

AUX IN AUX IN VOL CLICK VOL
KICK

PHONES POWER VOL ACCOMP VOL
PUSH ON OFF SNARE

PLAY TRIG
UTIL VOICE
CLICK SONG

REC MUTE TEMPO
START/S PAGE

SAVE/ENT SEL GRV

SHIFT VALUE+

DTXPRESS

GENERAL **midi**

SPECIAL MESSAGE SECTION

This product utilizes batteries or an external power supply (adapter). DO NOT connect this product to any power supply or adapter other than one described in the manual, on the name plate, or specifically recommended by Yamaha.

WARNING: Do not place this product in a position where anyone could walk on, trip over, or roll anything over power or connecting cords of any kind. The use of an extension cord is not recommended! IF you must use an extension cord, the minimum wire size for a 25' cord (or less) is 18 AWG. NOTE: The smaller the AWG number, the larger the current handling capacity. For longer extension cords, consult a local electrician.

This product should be used only with the components supplied or; a cart, rack, or stand that is recommended by Yamaha. If a cart, etc., is used, please observe all safety markings and instructions that accompany the accessory product.

SPECIFICATIONS SUBJECT TO CHANGE:

The information contained in this manual is believed to be correct at the time of printing. However, Yamaha reserves the right to change or modify any of the specifications without notice or obligation to update existing units.

This product, either alone or in combination with an amplifier and headphones or speaker/s, may be capable of producing sound levels that could cause permanent hearing loss. DO NOT operate for long periods of time at a high volume level or at a level that is uncomfortable. If you experience any hearing loss or ringing in the ears, you should consult an audiologist.

IMPORTANT: The louder the sound, the shorter the time period before damage occurs.

Some Yamaha products may have benches and / or accessory mounting fixtures that are either supplied with the product or as optional accessories. Some of these items are designed to be dealer assembled or installed. Please make sure that benches are stable and any optional fixtures (where applicable) are well secured BEFORE using. Benches supplied by Yamaha are designed for seating only. No other uses are recommended.

NOTICE:

Service charges incurred due to a lack of knowledge relating to how a function or effect works (when the unit is operating as designed) are not covered by the manufacturer's warranty, and are therefore the owners responsibility. Please study this manual carefully and consult your dealer before requesting service.

ENVIRONMENTAL ISSUES:

Yamaha strives to produce products that are both user safe and environmentally friendly. We sincerely believe that our products and the production methods used to produce them, meet these goals. In keeping with both the letter and the spirit of the law, we want you to be aware of the following:

Battery Notice:

This product MAY contain a small non-rechargeable battery which (if applicable) is soldered in place. The average life span of this type of battery is approximately five years. When replacement becomes necessary, contact a qualified service representative to perform the replacement.

This product may also use "household" type batteries. Some of these may be rechargeable. Make sure that the battery being charged is a rechargeable type and that the charger is intended for the battery being charged.

When installing batteries, do not mix batteries with new, or with batteries of a different type. Batteries MUST be installed correctly. Mismatches or incorrect installation may result in overheating and battery case rupture.

Warning:

Do not attempt to disassemble, or incinerate any battery. Keep all batteries away from children. Dispose of used batteries promptly and as regulated by the laws in your area. Note: Check with any retailer of household type batteries in your area for battery disposal information.

Disposal Notice:

Should this product become damaged beyond repair, or for some reason its useful life is considered to be at an end, please observe all local, state, and federal regulations that relate to the disposal of products that contain lead, batteries, plastics, etc. If your dealer is unable to assist you, please contact Yamaha directly.

NAME PLATE LOCATION:

The name plate is located on the top panel of the product. The name plate lists the product's model number, power requirements, and other information. The serial number is located on the rear panel. Please record the model number, serial number, and date of purchase in the spaces provided below, and keep this manual as a permanent record of your purchase.

Model

Serial No.

Purchase Date

PLEASE KEEP THIS MANUAL

92-BP (others)

NEDERLAND / THE NETHERLANDS

- Dit apparaat bevat een lithium batterij voor geheugen back-up.
- This apparatus contains a lithium battery for memory back-up.
- Raadpleeg uw leverancier over de verwijdering van de batterij op het moment dat u het apparaat aan het einde van de levensduur afdankt of de volgende Yamaha Service Afdeling:
Yamaha Music Nederland Service Afdeling
Kanaalweg 18-G, 3526 KL UTRECHT
Tel. 030-2828425
- For the removal of the battery at the moment of the disposal at the end of the service life please consult your retailer or Yamaha Service Center as follows:
Yamaha Music Nederland Service Center
Address : Kanaalweg 18-G, 3526 KL UTRECHT
Tel : 030-2828425
- Gooi de batterij niet weg, maar lever hem in als KCA.
- Do not throw away the battery. Instead, hand it in as small chemical waste.

(lithium disposal)

ADVARSEL!

Lithiumbatteri—Eksplodingsfare ved fejlagtig håndtering. Udskiftning må kun ske med batteri af samme fabrikat og type. Levér det brugte batteri tilbage til leverandøren.

VARNING

Explosionsfara vid felaktigt batteribyte. Använd samma batterityp eller en ekvivalent typ som rekommenderas av apparattillverkaren. Kassera använt batteri enligt fabrikantens instruktion.

VAROITUS

Paristo voi räjähtää, jos se on virheellisesti asennettu. Vaihda paristo ainoastaan laitevalmistajan suosittelemaan tyyppiin. Hävitä käytetty paristo valmistajan ohjeiden mukaisesti.

(lithium caution)

Caution

Always use the supplied Yamaha AC Adaptor to power DTXPRESS. The use of an incompatible adaptor may cause a serious shock hazard.

PRECAUTIONS

PLEASE READ CAREFULLY BEFORE PROCEEDING

* Please keep these precautions in a safe place for future reference.



WARNING

Always follow the basic precautions listed below to avoid the possibility of serious injury or even death from electrical shock, short-circuiting, damages, fire or other hazards. These precautions include, but are not limited to, the following:

- Do not open the instrument or attempt to disassemble the internal parts or modify them in any way. The instrument contains no user-serviceable parts. If it should appear to be malfunctioning, discontinue use immediately and have it inspected by qualified Yamaha service personnel.
- Do not expose the instrument to rain, use it near water or in damp or wet conditions, or place containers on it containing liquids which might spill into any openings.
- If the AC adaptor cord or plug becomes frayed or damaged, or if there is a sudden loss of sound during use of the instrument, or if any unusual smells or smoke should appear to be caused by it, immediately turn off the power switch, disconnect the adaptor plug from the outlet, and have the instrument inspected by qualified Yamaha service personnel.
- Use the specified adaptor (PA-3B or an equivalent recommended by Yamaha) only. Using the wrong adaptor can result in damage to the instrument or overheating.
- Before cleaning the instrument, always remove the electric plug from the outlet. Never insert or remove an electric plug with wet hands.
- Check the electric plug periodically and remove any dirt or dust which may have accumulated on it.



CAUTION

Always follow the basic precautions listed below to avoid the possibility of physical injury to you or others, or damage to the instrument or other property. These precautions include, but are not limited to, the following:

- Do not place the AC adaptor cord near heat sources such as heaters or radiators, and do not excessively bend or otherwise damage the cord, place heavy objects on it, or place it in a position where anyone could walk on, trip over, or roll anything over it.
 - When removing the electric plug from the instrument or an outlet, always hold the plug itself and not the cord.
 - Do not connect the instrument to an electrical outlet using a multiple-connector. Doing so can result in lower sound quality, or possibly cause overheating in the outlet.
 - Unplug the AC power adaptor when not using the instrument, or during electrical storms.
 - Before connecting the instrument to other electronic components, turn off the power for all components. Before turning the power on or off for all components, set all volume levels to minimum. Also, be sure to set the volumes of all components at their minimum levels and gradually raise the volume controls while playing the instrument to set the desired listening level.
 - Do not expose the instrument to excessive dust or vibrations, or extreme cold or heat (such as in direct sunlight, near a heater, or in a car during the day) to prevent the possibility of panel disfiguration or damage to the internal components.
 - Do not use the instrument near other electrical products such as televisions, radios, or speakers, since this might cause interference which can affect proper operation of the other products.
 - Do not place the instrument in an unstable position where it might accidentally fall over.
 - Before moving the instrument, remove all connected adaptor and other cables.
 - When cleaning the instrument, use a soft, dry cloth. Do not use paint thinners, solvents, cleaning fluids, or chemical-impregnated wiping cloths. Also, do not place vinyl, plastic or rubber objects on the instrument, since this might discolor the panel or keyboard.
 - Do not rest your weight on, or place heavy objects on the instrument, and do not use excessive force on the buttons, switches or connectors.
 - Use only the stand/rack specified for the instrument. When attaching the stand or rack, use the provided screws only. Failure to do so could cause damage to the internal components or result in the instrument falling over.
 - Do not operate the instrument for a long period of time at a high or uncomfortable volume level, since this can cause permanent hearing loss. If you experience any hearing loss or ringing in the ears, consult a physician.
- #### ■ REPLACING THE BACKUP BATTERY
- This instrument contains a non rechargeable internal backup battery which permits internal data to remain stored even when the power is off. When the backup battery needs replacing, the message "Battery Low" will display in the display. When this happens, immediately back up your data using an external device such as the floppy disk-based Yamaha MIDI Data Filer MDF3, then have qualified Yamaha service personnel replace the backup battery.
 - Do not attempt to replace the backup battery yourself, in order to prevent the possible serious hazards. Always have qualified Yamaha service personnel replace the backup battery.
 - Never place the backup battery in a location that a child can reach, since a child might accidentally swallow the battery. If this should happen, consult a physician immediately.
- #### ■ SAVING USER DATA
- Save all data to an external device such as the Yamaha MIDI Data Filer MDF3, in order to help prevent the loss of important data due to a malfunction or user operating error.

Yamaha cannot be held responsible for damage caused by improper use or modifications to the instrument, or data that is lost or destroyed.

Always turn the power off when the instrument is not in use.

***Thank you for purchasing the YAMAHA DTXPRESS.
The DTXPRESS is a compact drum trigger module that is equipped with
an AWM tone generator and sequencer functions.
To get the most out of your DTXPRESS, please read this manual carefully.
Also, after reading, keep this manual in a safe place for future reference.***

How to use the Manual

The DTXPRESS Owner's Manual is divided into the following two sections.

- **Basic Guide (P. 2-26)**

Please read this section before using the DTXPRESS.

This section contains cautions that must be followed for safe and proper use of the DTXPRESS.

Also, control and function names, connecting the pads and how to play the DTXPRESS, how to record and playback songs, how to create original drum kits are all described in this section.

- **Reference (P. 27-61)**

This section describes in detail each of the DTXPRESS' functions.

- **Appendix (P. 63-)**

At the rear of this book you will find an appendix section with specifications, error messages, drum voice, song, MIDI data format, etc. .

About the descriptions

This manual describes buttons and explanations using the following rules.

- [PLAY], [START/S], etc. The button on the front panel is indicated with []. (brackets).
- [SHIFT]+[START/S], etc. Means hold the [SHIFT] button and press the [START/S] button.
- [PAGE▲]/[PAGE▼], etc. Means use the [PAGE▲] button or [PAGE▼] button.
- "Complete!", etc. Words inside " " indicate the message shown on the display.
- → P. 10, etc. Indicates the reference page where further information can be found.

NOTE

The illustrations and LCD screens as shown in this owner's manual are for instructional purposes only, and may appear somewhat different from those on your instrument.

Inside this package

This package contains the following items. After opening the package, please check and makes sure that all the items In the list are present.

- **The DTXPRESS**
- **Power Adaptor**
- **Owner's Manual (this book)**

DTXPRESS Main Features

Along with the drum trigger function found in the DTXPRESS' compact half-rack 1U size body is a 32 voice polyphonic tone generator compatible with the GM System Level 1 standard and 2-track sequencer all especially designed for drummers.

You can use the DTXPRESS in many situations such as live performance, rhythm practice, original song creation and recording.

■ Drum Trigger Function

- 10 trigger input jacks and a hi-hat controller input jack are provided. Besides trigger pads you can also use Yamaha's DT10 Drum Triggers, etc. Stereo type pads are also compatible.
- Setup data for the connected pads, such as trigger input types, sensitivity, etc., consists of 7 preset patterns. A user area also provides 4 patterns.
- 48 preset drum kits as well as memory space for 32 user drum kits.

■ Tone Generator Section

- A high-quality 16-bit AWM2 (PCM) tone generator that complies with the GM System Level 1 standard. 32 voice polyphonic.
- A total of 910 drum and percussion voices as well as 128 keyboard voices that comply to the GM System Level 1.
- An internal digital reverb section that is the same as found in Yamaha's MU Series of GM/XG tone generators.
- User drum kits use a single drum map that can be edited freely.

■ Sequencer Section

- A 2-track sequencer for recording songs. Each track can contain data for MIDI channels 1-16.
- A total of 95 preset songs as well as a User Song Area that provides memory space for 32 original user songs.
- In addition to one main song that is controlled from the panel and with MIDI, 3 pad songs can be individually controlled and simultaneously played by trigger input from the pads.

- Pad songs can be played one measure at a time, each measure triggered with a stroke on a pad.
- Record your performance in real-time along with sequencer data from an external device.
- Easily mute the song's drum part or a specified drum voice and play along with the song.
- Playback in sync with an external sequencer is possible.
- Groove Check Function checks and provides instant feedback on your rhythmic skills offering a great way to improve your technique.

■ Interface

- Equipped with both MIDI IN/OUT jacks and a TO HOST jack. Connect the DTXPRESS to external MIDI devices or a computer to expand your system.
- The TO HOST jack and HOST SELECT switch provides direct connection to a computer.
- Connect a CD or MD player, etc. to the AUX IN jack and play along with your favorite recordings.
- Equipped with a headphone jack.



GM

"GM" (General MIDI) is a standard that provides common formats for tones to ease the transmission of MIDI song data and provide the compatibility to playback the original tones when tone generators by different manufacturers and of different types are used.

CONTENTS

Basic Guide

PRECAUTIONS	3
How to use the Manual	4
About the descriptions	4
Inside this package	4
DTXPRESS Main Features	5
Controls and Functions	8
Front Panel	8
Rear Panel	9
Setting Up	10
■ Connecting the pads	10
Setting up with Acoustic Drums	11
■ Connecting a Mixer or Audio Equipment	12
■ Connecting a MIDI Device	12
■ Connecting a Computer	12
■ Connecting a CD Player, etc. (AUX IN jack)	13
■ Connecting a Pair of Headphones (PHONES jack)	13
■ Connecting the Power Supply	13
The DTXPRESS Quick Guide (Basic Functions List)	14
Play the DTXPRESS!	16
Play Along with the Metronome	17
Play Along with a Song	18
Record Your Performance	20
Create Your Own Original Drum Kit	22
Getting More Out of Your DTXPRESS	24
■ Factory Set	24
■ Functions related to connections and input source (pads)	24
■ Set the Reverb	24
■ Settings related to the Drum Voice	24
■ Settings Related to the Tone Generator ...	25
■ Settings Related to the Song	25
■ Other Functions	25
■ Using MIDI	25
■ Connecting a Computer	26

Reference

DTXPRESS Internal Makeup	28
Drum Kit Play Mode	30
1. Drum Kit & Song	30
2. Trigger Setup & Tempo	30
3. Song & Mute	31
Groove Check Function	31
About the Song	32
Song Playback	32
Song Recording	34
Trigger Setup Edit Mode	35
1. INPUT Parameters	36
1-1. Pad Type	36
1-2. Gain, Minimum Velocity	36
1-3. Velocity Curve	37
1-4. Self Rejection, Rejection	37
1-5. Specific Rejection	37
1-6. Trigger Setup Copy	37
2. COMMON PARAMETERS	38
2-1. Increment/Decrement	38
2-2. Input Exchange	38
2-3. Trigger Setup Name	38
Drum Kit Voice Edit Mode	39
1. Voice Parameters	40
1-1. Voice	41
1-2. Volume, Pan	41
1-3. Tuning	41
1-4. Layer Balance	42
1-5. Decay, Cutoff Frequency	42
1-6. Note Number	42
1-7. Channel, Gate Time	42
2. Input Common Parameters	43
2-1. Cross Fade	43
2-2. Reverb Send	43
2-3. Alternate Group, Key Assign Mode	43
2-4. Hold Mode	44
2-5. Key Off Enable	44
2-6. Function	44
2-7. Pad Song	44
2-8. Rim To Pad	45
3. Reverb Parameter	45
3-1. Reverb Type, Time	45
3-2. Reverb Master Return	45

4. Setup	46
4-1. Program Change, Bank Select	46
4-2. Volume, Pan	46
4-3. Drum Kit Voice Copy	46
5. Drum Kit Common Parameters	47
5-1. Volume	47
5-2. Drum Reverb Send	47
5-3. Hi-hat Sensitivity	47
5-4. Song Select	47
5-5. Drum Kit Name	47
Song Job Mode	48
1. Tempo, Repeat Playback	48
2. Program Change, Bank Select	48
3. Volume, Pan	49
4. Song Copy	49
5. Quantize	49
6. Clear Track	50
7. Merge Track	50
8. Clear Song	50
9. Song Name	50
Utility Mode	51
1. SYSTEM Group	52
1-1. Learn Mode	52
1-2. Trigger Bypass	52
1-3. Volume Mode	52
1-4. Jump to Recent Page	52
1-5. Hi-Hat Offset	53
1-6. Factory Set	53
2. MIDI Group	53
2-1. Bulk dump	53
2-2. Channel 10 Program Change/Channel Event Receive	54
2-3. Receive Program Change/System Exclusive Messages	54
2-4. Program Change Table	55
2-5. MIDI Mode	55
2-6. Device Number, Local Control	55
2-7. MIDI Merge	55
2-8. Dump Interval	56
2-9. Send Hi-Hat Control	56
2-10. Host Thru Port	56
3. Sequencer Group	56
3-1. Click Voice	56
3-2. Click Tune	57
3-3. Click Note Number	57
3-4. MIDI Control	57

3-5. Count Switch	57
3-6. Sync Mode	57
3-7. Use Tempo	58
3-8. Click Mode	58
4. TG (Tone Generator) Group	58
4-1. Equalizer (EQ)	58
4-2. Tuning	58
4-3. Volume	58
4-4. Reverb Bypass	59
5. MAP (Drum Map) Group	59
5-1. Voice	59
5-2. Volume, Pan	60
5-3. Tuning	60
5-4. Layer Balance	60
5-5. Decay, Cutoff Frequency	60
5-6. Reverb Send	60
5-7. Alternate Group, Key Assign Mode	61
5-8. Key Off Enable	61
5-9. Map Copy	61

Appendix

Specifications	64
Error Messages	65
Trouble shooting	66
Drum Voice List	68
GM Keyboard Voice List	72
Preset Drum Kit List	72
Preset Song List	79
Trigger Setup List	79
MIDI Data Format	80
MIDI Implementation Chart	82
Index	83
Blank Chart	85

Controls and Functions

Front Panel

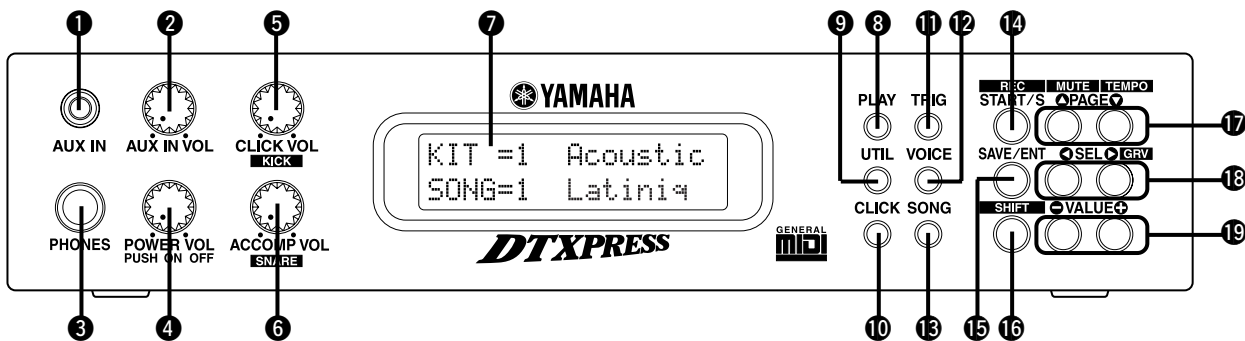

1 AUX IN Jack

Connect the output of an external audio device, etc., to this jack (stereo mini jack). (P. 13)

This is convenient for playing along with music from a CD or cassette player.

2 AUX IN Volume (AUX IN VOL)

This volume control adjusts the volume of a CD or cassette player connected to the AUX IN jack 1.

3 Head Phone Jack (PHONES)

Connect a pair of headphones to this jack to monitor the DTXPRESS. (P. 13)

4 Power Switch/Master Volume (POWER/VOL)

Switches the power ON/OFF and controls the overall volume level (output from the OUTPUT jacks and PHONES jack) of the DTXPRESS.

Rotate the knob clockwise to increase volume, counter-clockwise to decrease volume. Push the button to switch the power ON/OFF.

5 Click Volume (CLICK VOL)

This volume control adjusts the volume of the metronome's click. (P. 17)

Holding the [SHIFT] button and rotating the knob adjusts the volume of the bass drum.

6 Accompaniment Volume (ACCOMP VOL)

This volume control adjusts the volume of the song's accompaniment. (P. 18)

Holding the [SHIFT] button and rotating the knob adjusts the volume of the snare drum.

7 LCD Display

The LCD Display shows information and data that is necessary to operate the DTXPRESS.

8 Play Button (PLAY)

Press the button to enter the DTXPRESS' Drum Kit Play Mode.

9 Utility Button (UTIL)

Press the button to enter the Utility Mode that contains basic settings for operation of the DTXPRESS.

10 Click Button (CLICK)

Press this button to start/stop the metronome (click sound). (P. 17)

11 Trigger Button (TRIG)

Press this button to enter the Trigger Setup Edit Mode. Double-click the button to display the "Gain, Minimum Velocity" page of the Trigger Setup Edit Mode.

12 Voice Button (VOICE)

Press this button to enter the Drum Kit Voice Edit Mode.

Press the button while in the Drum Kit Edit Mode allows you to listen to the voice currently being set as if it were triggered from the pad (audition function).

Double-click the button to display the "Volume, Pan" page of the Drum Kit Voice Edit Mode.

Hold the [SHIFT] button and press the [VOICE] button to mute audio output from the OUTPUT JACK 27 and PHONES JACK 3.

13 Song Button (SONG)

Press this button to enter the Song Job Mode.

Double-click the button to display the "Clear Song" page of the Song Job Mode.

14 Start/Stop Button (START/S)

This button starts/stops playback or recording of the song.

Hold the [SHIFT] button and press [START/S] puts the DTXPRESS in recording standby mode.

15 Save/Enter Button (SAVE/ENT)

Carries out (enter) the command or save operation.

16 Shift Button (SHIFT)

Holding this button and pressing another specific button switches the button to its secondary function.

17 Page Button [PAGE▲, PAGE▼]

These buttons are used to navigate through the display pages. The [PAGE▲] button moves to the next page while the [PAGE▼] button moves to the previous.

Hold the button to continuously move through the pages. Hold the [SHIFT] button and press the [PAGE▲] button to mute the drum voice during playback (Rhythm Mute Function).

Hold the [SHIFT] button and press the [PAGE▼] button to display the Song Tempo Setting (P. 18)

18 Select Button [SEL◀, SEL▶]

Use these buttons to move the cursor.

Hold the [SHIFT] button and press the [SEL▶] button to switch to the “Groove Check Function”. (P. 17)

19 Value Button (VALUE–, VALUE+)

Changes the data value selected with the cursor.

Hold the button to continuously change the value.

Hold the [VALUE+] button and press the [VALUE–] button to increase the value by 10 continuously.

Hold the [VALUE–] button and press the [VALUE+] button to decrease the value by 10 continuously.

Rear Panel

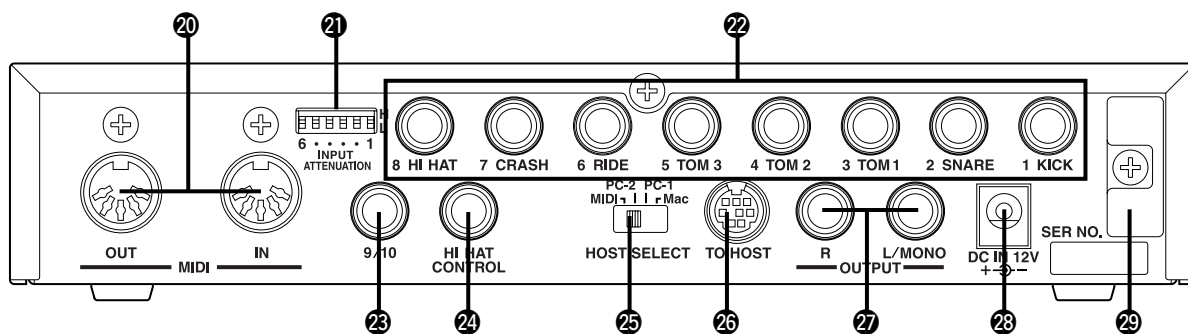

20 MIDI IN/OUT Jack

These jacks are for the transmission and reception of MIDI data to and from external MIDI devices.

Connecting external MIDI devices will expand the function of the DTXPRESS.

21 Input Attenuation Switch (INPUT ATTENUATION)

Sets the general Input Attenuation for each Trigger Input Jack (1 KICK-6 RIDE). Lowering the switch (L) lowers the attenuation. Raising the switch (H) increases attenuation. This adjusts the input level to meet the specification of pads and trigger sensors connected to the DTXPRESS. (P. 10)

22 Trigger Input Jack (1 KICK-8HI HAT)

Connect pads and trigger sensors to these jacks. Connect pads according to the indication below each input. (P. 10) Stereo output pads are also compatible with the DTXPRESS.

23 Trigger Input Jack (9/10)

Used to connect a pad to the DTXPRESS. The stereo jack's L corresponds to input 9, R corresponds to input 10. Using a stereo phone plug to connect two pads makes two-trigger input possible. If a monaural phone plug is used, only input 9 is available for use.

24 Hi-Hat Controller Jack (HI HAT CONTROL)

This jack is used to connect a hi-hat controller (P. 10).

* Use a cable with a stereo plug when connecting a Hi-hat controller.

25 Host Select Switch (HOST SELECT Mac/PC-1/PC-2/MIDI)

Set the switch according to the type of computer connected to the TO HOST jack 26. If the MIDI jack is used set the switch to the “MIDI” position. (P. 12, 26)

26 TO HOST Jack

This jack is used to connect a computer to the DTXPRESS with a serial cable. Use a cable that is compatible with the type of computer you are using. (P. 26)

27 Output Jacks (OUTPUT L/MONO, R)

These jacks are used to connect the DTXPRESS to an external amplifier, mixer, etc. For monaural playback use the L/MONO jack. For stereo playback connect both L/R jacks.

28 Power Supply Jack (DC IN 12V)

Connect an AC adaptor to this jack. To prevent the adaptor from becoming unplugged, secure the cord to the cord hook 29.

29 Cord Hook

Prevents the power cord from accidentally becoming unplugged. (P. 13)

Setting Up



To prevent electric shock and damage to the devices, make sure the power is switched OFF on the DTXPRESS and all related devices before making any connections to the DTXPRESS' input and output jacks.

■ Connecting the pads

Referring to the illustration shown below, connect the output cable from each pad to each Trigger Input Jack located on the rear panel of the DTXPRESS.

The Trigger Input Jacks are all labeled (1 KICK, etc.) so make sure you connect each pad to its corresponding Trigger Input Jack.

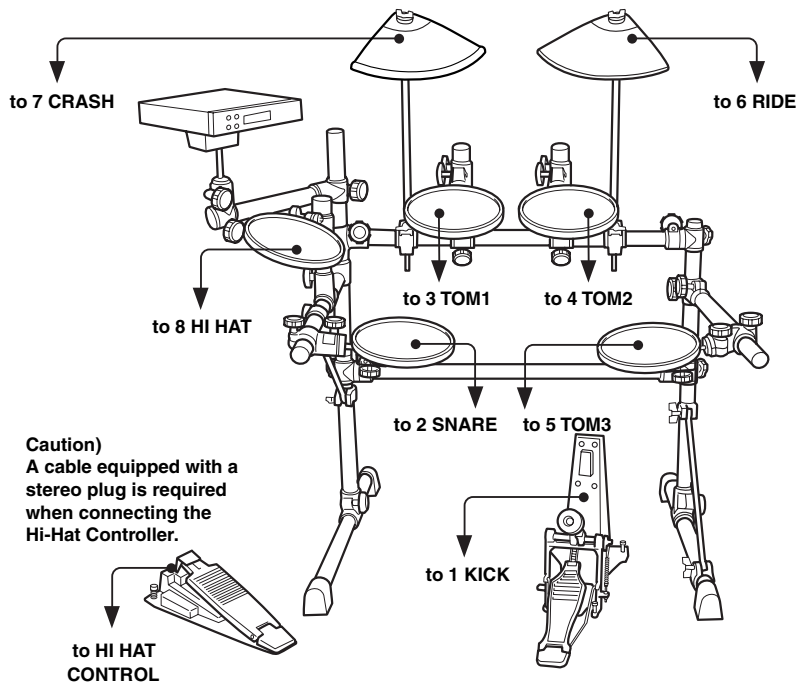

● For a move flexible snare/Hi-Hat setup, set the pads as shown in the illustration below.

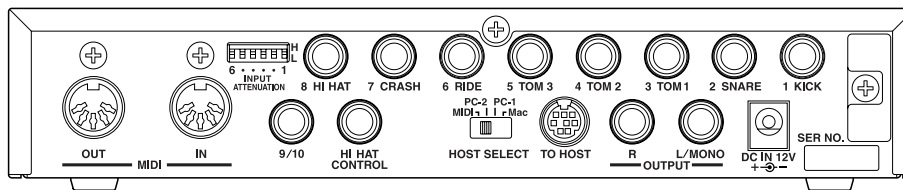
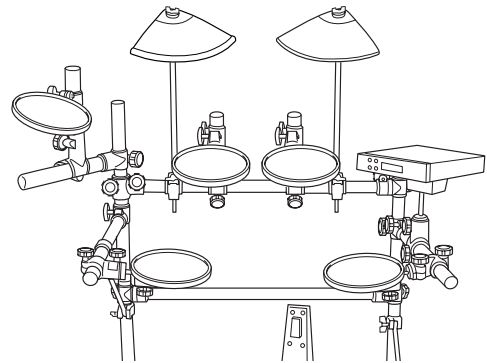

- Trigger Input Jacks are all stereo input type jacks. Pads equipped with trigger switches like the TP80S, PCY80S, etc. can be connected to these jacks.
- When a pad corresponding to the labeled input jack (1 KICK, etc.) is connected, the DTXPRESS will automatically assign settings suitable for the pads. However, when pads and drum triggers that possess different characteristics are connected, it will be necessary to assign suitable settings for parameters such as sensitivity, etc.
- Sensitivity is set in the Trigger Setup Edit mode's [1-1. Pad Type] (P. 36). By double clicking the [TRIG] button, you can hit the pad you want to set and the DTXPRESS display will automatically jump to the proper setting display.
- The input sensitivity switches (INPUT ATTENUATION) are sensitivity switches that correspond to Trigger Input Jacks 1 KICK-6 RIDE.

The switch's L position corresponds to a low sensitivity for pads like TP, KP, PCY, BP, etc. The H position corresponds to a high sensitivity proper for use with the DT10 Drum Trigger, etc.

- It is possible to connect the TP60, TP80S, PCY80S, etc. pads to the 1 KICK jack. You can also use the Hi-Hat Controller HH60, HH80, HH80A as a kick pedal (Use [1-1. Pad Type] to assign settings.).
- In addition to the 1 KICK jack, the 9/10 jack can be used to connect a second bass drum pedal to create a double-bass drum set.
- The 9/10 jacks correspond to a 2-trigger input that uses a stereo jack for L (9) and R (10). We recommend the use of these jacks when connecting the Yamaha Bar Pad (BP-80). You can use a conversion cable plug (stereo plug → monaural plug x2) to input two separate trigger signals.

Setting up with Acoustic Drums

With the optional Yamaha DT10 Drum Triggers attached to a set of acoustic drums, it is possible to connect acoustic drums to the DTXPRESS.

■ A setup example using both acoustic drums and drum pads.

Referring to the illustration shown below, connect the output cable from each pad and drum trigger to each Trigger Input Jack located on the rear panel of the DTXPRESS.

* When using the drum triggers, appoint suitable settings in the Trigger Setup Edit mode's [1-1. Pad Type]. (P. 36)

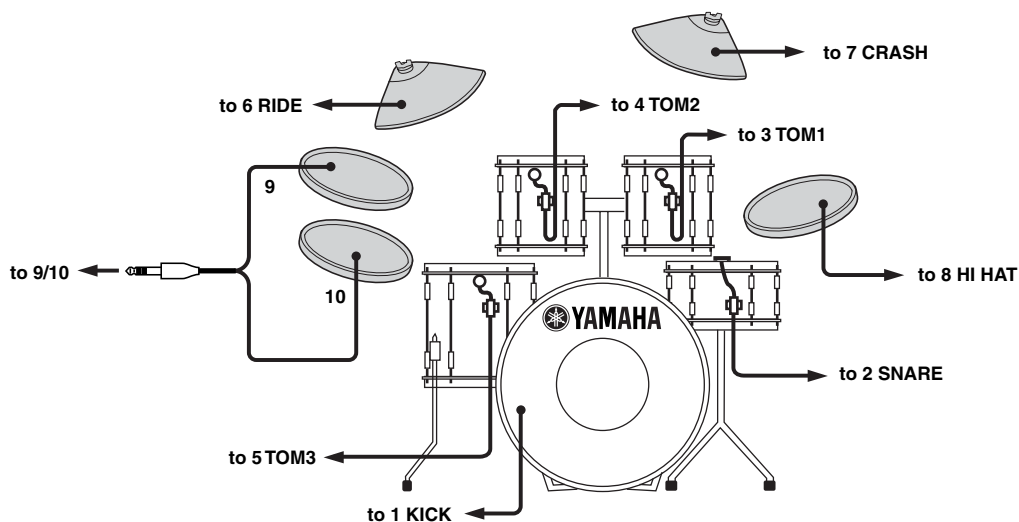

■ Attach the Drum Trigger

Use the following procedure to attach the drum trigger sensors to your acoustic drums.

• Attach to the Bass Drum

Mount the drum trigger sensor on the batterhead of the bass drum close to the edge of the rim.

* Make sure the sensor does not come in contact with the rim.

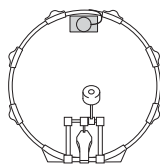

• Attach to the Snare Drum

Mount the drum trigger sensor on the batterhead of the snare drum close to the edge of the rim across player.

* Make sure the sensor does not come in contact with the rim.

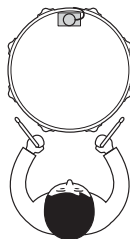

• Attach to the Toms

Mount the drum trigger sensor on the shell close to the edge of the rim.

* Make sure the sensor does not come in contact with the rim.

* Place the trigger in a position where other instruments (drum or percussion) will not influence it.

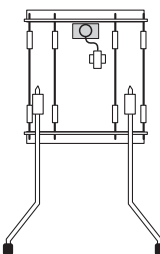

■ Removing the Drum Triggers

When changing the batterhead, carefully remove the drum trigger sensors with a knife, etc. before loosening the head.

* Be careful not to pull the cord when removing the trigger.

Taking Care of the Drum Triggers

- Make sure the surface of the batterhead or shell where the trigger is to be mounted is free from dirt and grime. Clean the surface with alcohol, etc. before attaching.
- To prevent broken trigger cords caused by the vibration of the drum rim, secure the sensors and cords in place with tape.
- Irregular vibration and sustained resonance on the batterhead or shell may cause double-triggering. This can be prevented by applying a mute to the batterhead and controlling excessive vibration. We recommend the use of the Yamaha Ring Mute.
- Once you have removed drum triggers and want to mount them again, be sure completely remove the old tape and apply new tape. Using used tape may cause problems such as poor sensitivity, double-triggering, etc.

Setting Up

■ Connecting a Mixer or Audio Equipment

Connecting the OUTPUT L/MONO and R jacks on the rear of the DTXPRESS to a mixer or audio equipment allows for audio reproduction through external speakers or the recording of your performance.

• Using speakers with built-in amplifiers.

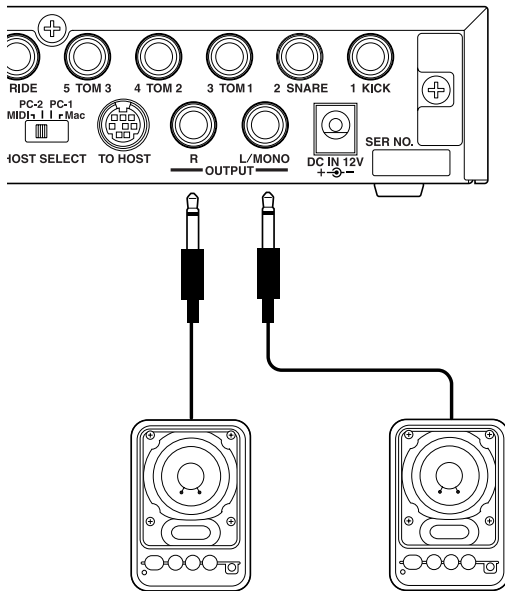

• Recording your performance with the DTXPRESS to a cassette tape deck.

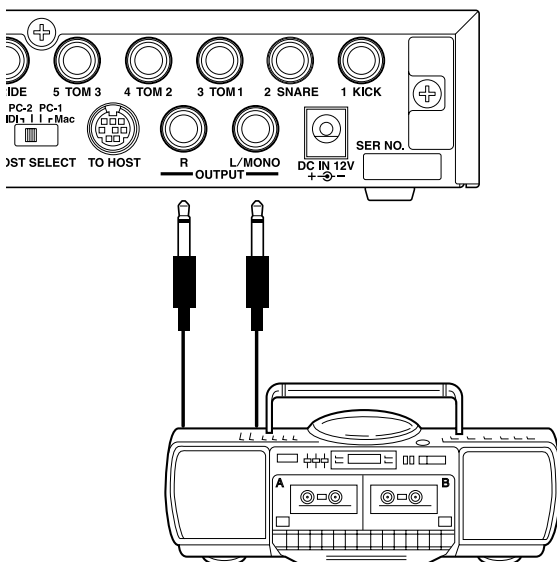

- * The OUTPUT jack is a standard monaural type phone jack. Please use a cable equipped with a plug that matches device.
- * When connecting to a monaural input device, please use the OUTPUT L/MONO jack on the DTXPRESS.

■ Connecting a MIDI Device

Data in the DTXPRESS can be stored (Bulk Dump) to a Yamaha MIDI Data Filer MDF3, etc. or other MIDI device.

Also, an external sequencer can be used to drive the DTXPRESS' Tone Generator.

Furthermore, the use of MIDI functions allows for a wide range of possibilities with the DTXPRESS.

Refer to the [Using MIDI] section (P. 25) on how to use MIDI functions.

• Transmit MIDI Data

Use a MIDI cable to connect the MIDI OUT jack on the DTXPRESS with the MIDI IN jack on the external MIDI device. Set the HOST SELECT switch to the "MIDI" position.

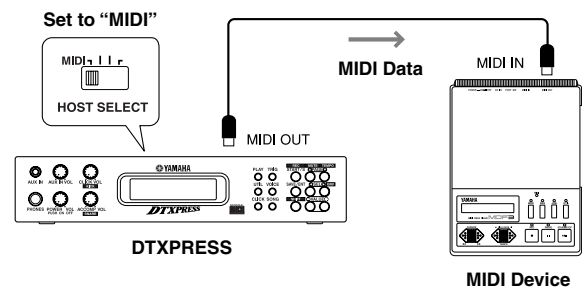

• Receive MIDI Data

Use a MIDI cable to connect the MIDI IN jack on the DTXPRESS with the MIDI OUT jack on the external MIDI device.

Set the HOST SELECT switch to the "MIDI" position.

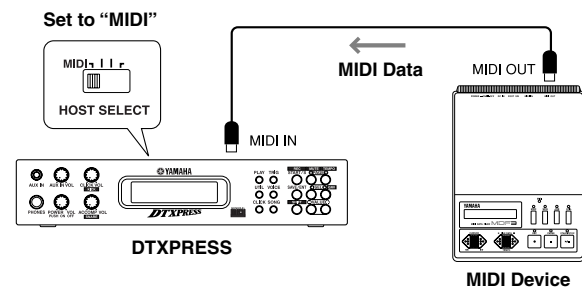

Always use a standard MIDI cable when connecting devices. Also, use a MIDI cable that is not more than 15m in length. Using a longer cable may result in irregular operation and other problems.

■ Connecting a Computer

The DTXPRESS is equipped with a built-in MIDI interface that allows the DTXPRESS to be connected directly to a computer's serial board via the DTXPRESS' TO HOST jack.

Sequencer software installed in the computer can be used to drive the keyboard voices of the DTXPRESS and sequence data created in the DTXPRESS can be edited in the computer.

Refer to the [Connecting a Computer] section (P. 26) for more information.

■ Connecting a CD Player, etc. (AUX IN jack)

The audio output from a CD player or cassette deck connected to the AUX IN jack (stereo mini) on the front panel can be mixed with the sound of the DTXPRESS and transmitted via the output jacks on the rear panel.

This function is convenient when you want to play along with a favorite song or enjoy performing with your friends.

The volume of the external signal is adjusted with the AUX IN VOL knob.

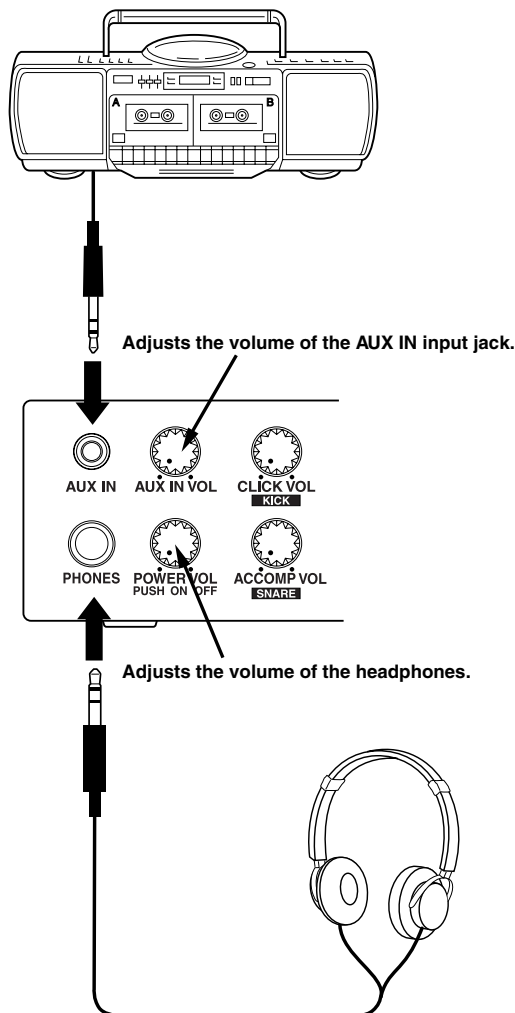

■ Connecting a Pair of Headphones (PHONES jack)

When you want to listen to the DTXPRESS with a pair of headphones, connect the headphones to the PHONES jack (stereo standard) on the front panel.

The headphone volume is adjusted with the POWER/VOL knob.

When using the headphones, do not damage your hearing. Adjust the volume to a comfortable level.

■ Connecting the Power Supply

A special power source adaptor supplies power to the DTXPRESS.

Make sure the power is switched OFF and connect the supplied power adaptor to the DC IN jack on the rear panel.

To prevent the cord from becoming unplugged, wrap the cord around the cord hook and secure.

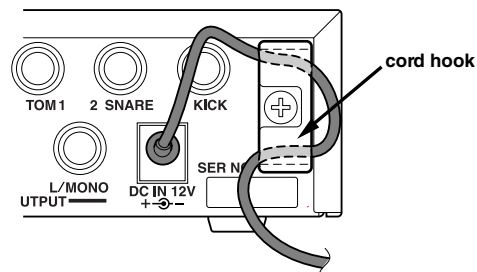

! Please use the supplied power adaptor. The use of any other power source may cause irregular operation or damage to the device. Also, when the DTXPRESS is not to be used for a long period of time, please unplug the power adaptor.

Before switching the power ON.

- To protect the speakers, headphones and the DTXPRESS from damage, fully rotate the POWER/VOL knob to the left (minimum volume) before switching the power ON.
- Make sure the power is switched OFF on all external devices connected to the DTXPRESS. After the DTXPRESS' power is switched ON, switch the other device's power ON.

The DTXPRESS Quick Guide (Basic Functions List)

Play the DTXPRESS along with your favorite CD or MD! (Connect the line out from a CD or MD player here.)

Control the volume of a CD or MD player with this knob.

Controls the volume of the metronome's click voice!
Hold the [SHIFT] button and rotate this knob to change the volume of the bass drum!

Connect a pair of headphones here to monitor the DTXPRESS!

Press the knob to switch the power ON!
Rotate the knob to adjust the overall volume (transmitted to the OUTPUT jack). Also controls the headphone volume.

Controls the volume of the song accompaniment!
Hold the [SHIFT] button and rotate this knob to change the volume of the snare drum!

YAMAHA
KIT =1 Acoustic
SONG=1 Latin4
DTXPRESS
GENERAL MIDI

Select the drum kit, song, and set the song tempo and metronome.
→ Enters the Drum Kit Play mode.

Set the basic settings and settings for MIDI and the sequencer of the DTXPRESS.
→ Enters the Utility mode

Starts/stops the metronome!

Sets the pad's sensitivity and dynamic range.
→ Enters the Trigger Setup Edit mode.

Change the instrument voice for each pad in the drum kit or add reverb.
→ Enters the Drum Kit Voice Edit mode.

Edit the songs you create.
→ Enters the Song Job mode.

PLAY TRIG
UTIL VOICE
CLICK SONG

Hold the [SHIFT] button and press this button to mute the song's drum part.

Start/stop playback of the song!
Hold the [SHIFT] button and press this button to start recording.

Save settings to the DTXPRESS' memory.

Set a secondary function for the buttons and knobs.

Hold the [SHIFT] button and press this button to display the Tempo setting display!

Navigate through the setting display's pages.

Moves the cursor (flashing character).

Changes the value of the parameter selected with the cursor.

Hold the [SHIFT] button and press this button to display the Groove Check display!

REC MUTE TEMPO
START/S PAGE
SAVE/ENT SEL GRV
SHIFT VALUE

Listen to the Selected Song

1. Press the [PLAY] button to open this display,

```
KIT =1 Acoustic
SONG=1 Latini4
```

Song Number Song Name

2. Use the [SEL◀]/[SEL▶] buttons to flash the song number.
3. Use the [VALUE-]/[VALUE+] buttons to select the song.
4. Press the [START/S] button to start playback!

Change the Song's Tempo

1. Hold the [SHIFT] button and press the [PAGE▼] button to open this display,

```
TRIG =1 Medium
┆=110=---= 4/4=┆
```

Tempo

2. Use the [SEL◀]/[SEL▶] buttons to flash the tempo value.
3. Use the [VALUE-]/[VALUE+] buttons to set the tempo.

Set the Metronome

1. Hold the [SHIFT] button and press the [PAGE▼] button to open this display,

```
TRIG =1 Medium
┆=110=---= 4/4=┆
```

Tempo Beat Note

2. Use the [SEL◀]/[SEL▶] buttons to flash the parameter you want to set.
3. Use the [VALUE-]/[VALUE+] buttons to set the value.

Change the Pad's Sensitivity

1. Double-click the [TRIG] button to open this display,

```
TRIG IN= 1 ( 0%)
Gain=64 MVel= 32
```

Input Gain (Sensitivity)

2. Hit the pad that you want to edit (that pad will be selected).
3. Use the [SEL◀]/[SEL▶] and [VALUE-]/[VALUE+] buttons to edit.

Change the Output Sound Quality

1. Double-click the [UTIL] button to open this display,

```
UT TG MASTER
EQ Lo=+ 6 Hi=+ 0
```

Bass Treble

2. Use the [SEL◀]/[SEL▶] buttons to select either "Lo" (bass) or "Hi" (treble),
3. Use the [SEL◀]/[SEL▶] and [VALUE-]/[VALUE+] buttons to edit.

Select a Drum Kit

1. Press the [PLAY] button to open this display,

```
Drum Kit Number      Drum Kit Name
KIT =1 Acoustic
SONG=1 Latini4
```

2. Use the [SEL◀]/[SEL▶] buttons to flash the drum kit number,
3. Use the [VALUE-]/[VALUE+] buttons to select a drum kit.

Change the Voice Volume For Each Pad

1. Double-click the [VOICE] button to open this display,

```
KIT IN=pad 1 U=-
Vol= 116 Pan= C
```

Volume Level

2. Hit the pad whose volume you want to change (that pad will be selected),
3. Use the [SEL◀]/[SEL▶] and [VALUE-]/[VALUE+] buttons to edit.

Change the Pad's Voice

1. Press the [VOICE] button to open this display,

```
KIT IN=pad 1 U=-
=K/017 BDaftw1
```

Voice Category Voice Number

2. Hit the pad whose voice you want to change (that pad will be selected),
3. Use the [SEL◀]/[SEL▶] and [VALUE-]/[VALUE+] buttons to select the voice category and voice number.

Change the Reverb for the Drum Voice

1. After selecting the drum kit you want to add reverb to, press the [VOICE] button, use the [PAGE▲]/[PAGE▼] buttons to open this display.

```
KIT IN=pad 1
Reverb send= 15
```

Reverb Send Level

2. Use the [SEL◀]/[SEL▶] and [VALUE-]/[VALUE+] buttons to edit the reverb send level.

Save the Edited Settings

1. Press either the [VOICE] or [TRIG] button, use each mode's display to edit the settings.
2. Press the [SAVE/ENT] button,
3. Use the [VALUE-]/[VALUE+] buttons to set the save address.

```
Store Drumkit
To= 49 Init kit
```

Save Address

4. Press the [SAVE/ENT] button, after the confirmation display appears, press the [SAVE/ENT] button again.

Play the DTXPRESS!

Now that you have the DTXPRESS properly connected, let's make some music!

1. Switch the power ON

After confirming that each of the devices, pads, external devices, etc. are all properly connected, push the POWER/VOL knob on the front panel to switch the power ON.

The DTXPRESS is ready to operate when the display, shown below, for selecting the drum kit and song appears.

* The previously selected drum kit or song will be displayed.

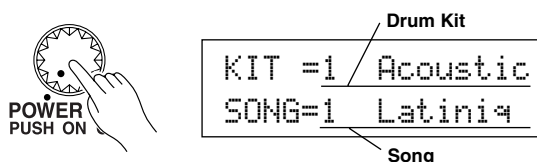

! To avoid damage to your speakers, first switch the DTXPRESS' power ON then switch on Audio Devices and the Mixer or Amplifier.

2. Hit a pad

While hitting a pad, rotate the POWER/VOL knob little by little to the right until a comfortable volume level is reached. The volume level is increased as the knob is rotated to the right and decreased as it is rotated to the left.

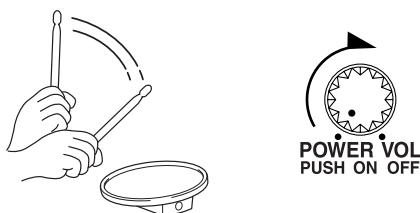

3. Change the Drum Kit

Try out the voices for each of the kits.

Drum kit numbers 1-48 consist of 48 types of preset drum kits that have been specially programmed by Yamaha. → [Pre-set Drum Kit List] (P. 72)

Use the [SEL◀]/[SEL▶] buttons to move the flashing cursor to the drum kit number, then use the [VALUE-]/[VALUE+] buttons to select the drum kit.



Try out the different drum kits and select one drum kit you like.

* Some drum kits have Pad Songs and Drum Loop Voices that will start when the corresponding pad is hit.

4. Change the instrument volume for each pad.

- Hold the [SHIFT] button and rotate the Click VOL knob to adjust the volume of the Bass Drum.

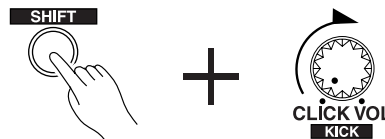

- Hold the [SHIFT] button and rotate the ACCOMP. VOL knob to adjust the volume of the Snare Drum.

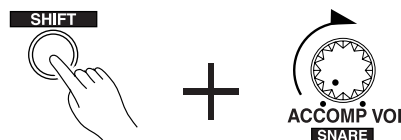

* The Bass Drum and Snare Drum volume settings, described above, will reset when the power is switched off.

- Double-click the [VOICE] button, the volume setting display for each pad (Input Source) will be displayed.

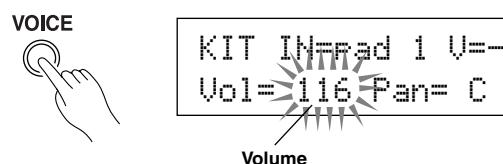

Hit the pad you want to adjust the volume of and use the [VALUE-]/[VALUE+] buttons to adjust the volume.

* The same display can be used to adjust the pan (the position of the voice within the stereo field) for each pad. (P. 41)

HINT According to the setting in the Utility mode's [1-3. Volume Mode] (P. 52), the volume of the cymbal, drums and other instruments can be adjusted using the knobs shown above.

5. Change the sound quality heard through the monitor.

Double-click the [UTIL] button, the sound quality setting display for the audio signal that is transmitted to the OUTPUT jacks and PHONES jack will be displayed.

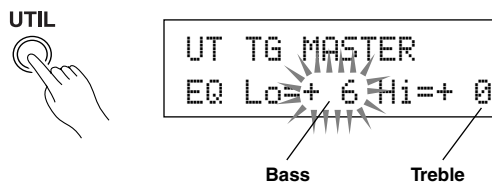

Press the [SEL◀]/[SEL▶] buttons to move the flashing cursor to the Lo or Hi position, then use the [VALUE-]/[VALUE+] buttons to adjust the sound quality.

Play Along with the Metronome

Play the DTXPRESS along with the metronome.
Try out the Groove Check Function to check your rhythmic accuracy.

1. Turn On the Metronome

Press the [CLICK] button to start the metronome.
The lamp in the [CLICK] button will light every beat of each measure.
Press the [CLICK] button again to stop the metronome.
The click voice volume is adjusted with the CLICK VOL knob.



1-1. Set Metronome Tempo

Hold the [SHIFT] button and press the [PAGE▼] button, the tempo setting display will appear.
Use the [SEL◀]/[SEL▶] buttons to move the flashing cursor to the tempo value, then use the [VALUE-]/[VALUE+] buttons to set the desired tempo.
The Tempo setting range is ♩=30-300.

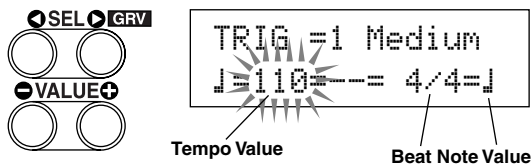

1-2. Set the Metronome Beat

In the setting display shown above, press the [SEL▶] button to move the flashing cursor to the beat value, then use the [VALUE-]/[VALUE+] buttons to set the desired beat.
The Beat setting range is 1/4-8/4, 1/8-16/8, 1/16-16/16.

1-3. Set the Metronome Note Value

In the setting display shown above press the [SEL▶] button to move the flashing cursor to the note value, then use the [VALUE-]/[VALUE+] buttons to set the click tempo (finer quantization).

1-4. Set the Click Voice and Other Settings

The metronome produces three different click voices.
“hi” will sound at the top of the measure, “mid” will sound on every quarter note and “lo” will sound on the beats of finer quantization.
Each of the click voices can be set to any voice (drum instrument voices) and pitch you like.
In the next section [Play with the Song] we will explain how to change the voices in detail.
Refer to the Utility mode’s [3. Sequencer Group] (P. 56) section for more information.

2. Use the Groove Check Function

As you play the pads, the DTXPRESS’ Groove Check function will check your rhythmic accuracy and display the results.
Your timing is compared to the click of the metronome and the accuracy is displayed.

2-1. Set the Metronome

Before you use the Groove Check Function, you will have to select the tempo, beat and finer quantization that matches the type of rhythm you want to practice.

2-2. Display the Groove Check Function

Hold the [SHIFT] button and press the [SEL▶] button to display the Groove Check Function shown below.

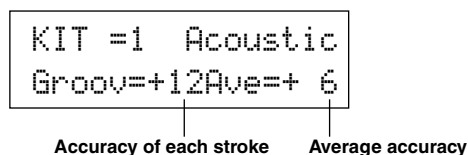

2-3. Hit a Pad in Tempo with the Metronome

Press the [CLICK] button to start the metronome, then hit the snare drum pad.

- The number that is displayed next to “Groov=” on the left side of the display indicates the accuracy of each stroke on the pad.
A “-” (minus) value is displayed when your timing is later than that of the click voice (just timing) and a “+” (plus) value is displayed when your timing is earlier than that of the click voice.
- The number that is displayed next to “Ave=” on the right side of the display indicates the overall accuracy or average of the values that are displayed next to “Groov=”. The Groove Function can be used to check your accuracy on the entire drum set or on an entire song.

The Groove Check Function can be used not only on the snare drum, but on any of the DTXPRESS’ pads. Also, you can change the metronome’s pattern to a sixteenth or triplet note feel. Try practicing with some of the other settings.

- * Hold the [SHIFT] button and press the [SEL▶] button twice to reset the data.

Play Along with a Song

The DTXPRESS has a total of 95 preset songs that are good for rhythm practice. Try and play along with a song.

1. Select a Song

Select one of the DTXPRESS' songs and listen to it. Song numbers 1-95 are preset songs that have been created by Yamaha.

→ [Preset Song List] (P. 79)

Press the [PLAY] button to display the Drum Kit & Song display.

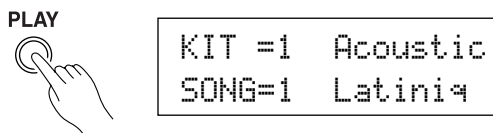

Use the [SEL◀]/[SEL▶] buttons to move the flashing cursor to the song number, then use the [VALUE-]/[VALUE+] buttons to select the song.



* When a song is switched, the drum kit also changes to a kit that is set for that song.

2. Listen to the Song

When the [START/S] button is pressed, the song will start playback from the beginning.

The [SONG] lamp in the button will light on the first beat of each measure.



The song will stop when it reaches the end.

You can stop the song during playback by pressing the [START/S] button.

* Some songs repeat.

HINT Before song playback, you can have the metronome give a two-measure count. (→ Utility Mode [3-5. Count Switch] Reference Guide : P. 33)

3. Mute a Drum Part

Try playing along with the song.

Hold the [SHIFT] button and press the [PAGE▲] button, then press the [START/S] button to playback the song. A drum part in the song will be muted (does not produce the part) (Rhythm Mute Function).

You will play the drum part.

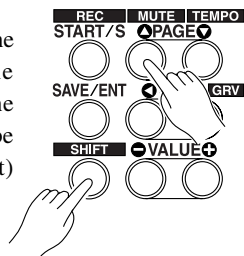

While setting the Rhythm Mute, a "M" will be displayed at the end of the song name.

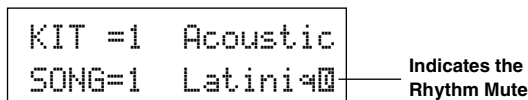

To cancel the Rhythm Mute, hold the [SHIFT] button and press the [PAGE▲] button again.

HINT The mute function can be used during song playback. To cancel the Mute, hold the [SHIFT] button and press the [PAGE▲] button again.

4. Adjust the Song Volume

The song volume is adjusted with the ACCOMP VOL knob. Use both the ACCOMP VOL knob and the POWER/VOL knob (overall volume of song and pads) to adjust the balance between the song and your drum part.

5. Change the Song's Tempo

Hold the [SHIFT] button and press the [PAGE▼] button to display the Tempo Setting display.

In the same manner as the metronome, use the [SEL◀]/[SEL▶] to move the flashing cursor to the Tempo value, then use the [VALUE-]/[VALUE+] buttons to set the desired tempo (♩=30-300).

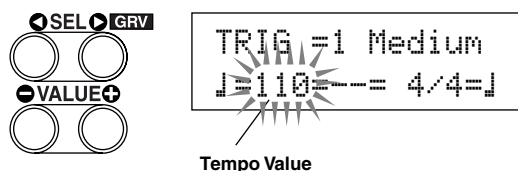

Press the [PAGE▲] button to return to the original display (Drum Kit & Song setting display).

6. Play Along with the Click Voice

With the drum part muted, it may be a little difficult to keep time. In this case, use the metronome along with the song. Using the click voice as a reference will make it easier to play along with the song.

Press the [CLICK] button to start the metronome. It will be in tempo with the song. Press the [CLICK] button again to stop the metronome.

The Click Voice's volume can be adjusted using the CLICK VOL knob.



HINT The metronome (click voice) can be set to start/stop when the song starts/stops. (→ [3-8. Click Mode] (P. 58))

7. Change the Click Voice

When the click voice resembles voices that are found in the song it might be hard to hear. In this case it is a good idea to change the click voice.

- We will use the factory set 4-beat click voice (a high and low bell voice) as an example here.

Change voice that is heard on the first beat.

Slowly press the [UTIL] button three times and the following display will appear.

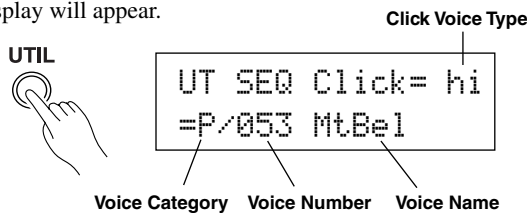

7-1. First, use the [SEL◀]/[SEL▶] buttons to move the flashing cursor to the Click Voice Type position, then use the [VALUE-]/[VALUE+] buttons to assign the “hi” click voice (the click voice heard on the first beat).

7-2. Next, use the [SEL◀]/[SEL▶] buttons to move the flashing cursor to the Voice Category position, then use the [VALUE-]/[VALUE+] buttons to assign the Drum Voice Category that will be used for the Click Voice. Each of the following characters indicates a drum voice category.

- K: Acoustic Kick
- k: Electric Kick
- S: Acoustic Snare
- s: Electric Snare
- T: Acoustic Tom
- t: Electric Tom
- C: Cymbal
- H: Hi-hat
- P: Percussion
- E: Effect 1
- e: Effect 2
- L: Drum Loop
- m: misc. voices

Here, select the misc. voices “m”.

7-3. After selecting the category, press the [SEL▶] button to move the flashing cursor to the Voice Number, then use the [VALUE-]/[VALUE+] buttons to assign the drum voice that will be used for the click voice.

Here, select “010 Marimba”.

Press the [CLICK] button to start the metronome and the marimba voice will be delivered instead of the previously assigned voice.

The same procedure can be used to change the other click voices (“mid”, “lo”) to a voice you prefer.

Press the [PLAY] button to return to the original display (Drum Kit & Song setting display).

8. Change the Drum Kit

When you want to use a different drum kit with a particular song, change only the drum kit number using the Drum Kit & Song setting display.

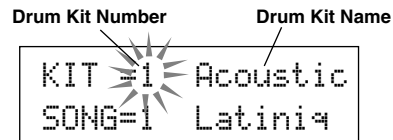

9. Change the Song but Not the Drum Kit

Normally, when the song is switched the drum kit will be automatically switched to the kit that is set in the song. However, if the Rhythm Mute Function ([SHIFT]+[PAGE▲]) is used, the drum kit will not change when the song is switched.

* Also, in the Utility mode's [2-2. Channel 10 Program Change/Receive Channel Event] (P. 54) set the Channel 10 Program Change to not receive program changes and then only the song will change.

10. Mute Individual Drums

You can mute individual drums like the [Bass Drum], [Snare Drum], [Cymbal], [Other Drum Instruments].

This function is convenient when you want to practice individual drum parts.

In the Drum Kit & Song setting display, press the [PAGE▼] button twice, the following display (Song & Mute) will appear.

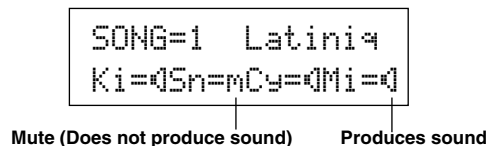

Use the [SEL◀]/[SEL▶] buttons to select the drum instrument (Ki: Bass Drum, Sn: Snare Drum, Cy: Cymbal, Mi: others) you want to mute, then press the [VALUE+] button to change the speaker icon (🔊) to the mute icon (🔇).

To cancel the Mute Function, press the [VALUE-] button to return to the speaker icon (🔊).

Record Your Performance

Next, let's try recording your performance to the DTXPRESS' sequencer. With song data you record you can switch drum kits, change the tempo and playback in the same way as preset songs.

■ Recording System

- Recording can be done in any of the user songs (No. 96-127) that supplied for recording. You cannot record to preset songs (No. 1-95).
- User songs contain 2 tracks that can be recorded to. Recording can be done one track at a time.
- The song records (memory) data that precisely relates to when and how each pad was hit, and stores that information. This is called sequence data. MIDI data from the MIDI IN/TO HOST jacks can be recorded simultaneously.
- Sequence data can be freely used to change the tempo, select the voice or drum kit during playback.
→ P. 48 [2. Program Change, Bank Select]
- Before recording, set the number of measures for the song you want to record. Recording is done in real-time. When the end of the assigned measure is reached, the record function can be set to act in one of two ways. (1) The song will automatically stop (Replace) and recording will be complete. (2) The song will repeat from its beginning and further data can be added to the previously recorded data (Overwrite).

OK, Let's Start Recording

1. Select the Song You Want To Record

Press the [PLAY] button to display the Drum Kit & Song display, select a User Song number (No. 96-127).

- * User songs that already contain data in both tracks cannot be recorded to.
- * If a song is not selected when you start to record, the lowest numbered empty user song will automatically be selected to record. In the same manner, an empty user song will be selected if a preset song has been selected for recording.

2. Set the Recording Conditions

Hold the [SHIFT] button and press the [START/S] button, the following Recording Conditions setting display will appear. Use the [SEL◀]/[SEL▶] buttons to select the parameter you want to set, then use the [VALUE-]/[VALUE+] buttons to set each of the following recording conditions.

2-1. Set the Number of Measures to be Recorded.

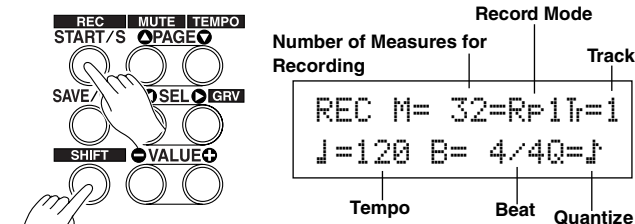

Determine the number of measures you want to record and set.

- * When there is data in the other track, the number of measures in that track will determine the length of the song.

2-2. Select the Record Mode

Select the method for recording from the following record modes.

Overwrite (OVR): The record operation will be in a repeat mode. When the song reaches the end of the last measure, it will automatically start again from the beginning and new data will be added to the track's previous data.

Replace (R=1): When the song reaches the end of the assigned measure or the [START/S] button is pressed, recording will stop (will not repeat).

2-3. Set the Track For Recording

Select either track 1 or 2 for recording.

2-4. Set the Metronome's Tempo and Beat

Set the tempo and beat that will be used by the Metronome when recording.

2-5. Set the Quantize Function

The Quantize function is used to align the timing of your performance with that of the nearest specified beat. The accuracy of quantization is assigned with a note value. The quantize function can be used when recording.

- * If this function is set to "no", the quantize function will not operate.
- * You can use the Quantize function after recording is complete. (P. 49)

● How Quantize Works (an example)

- Recorded notes were not played in time.



- The Quantize Function aligns the timing.

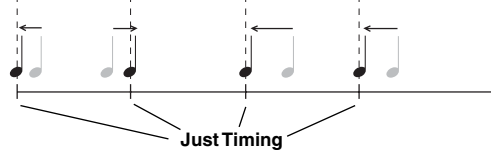

3. Start Recording

Press the [START/S] button, after a two-measure count recording will start. Record while listening to the metronome's click voice.

- * When the track assigned for recording contains data and the [START/S] button is pressed, the error message "Data not Empty" will appear and the recording operation will not be carried out.

● **When the Record Mode is set to Replace (“R=1”).**

The following display will appear while recording (only displayed, cannot be changed).

The measure number currently being recorded.

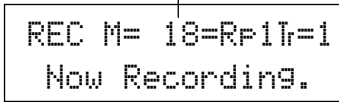

When the end of the assigned measure number is reached, recording will automatically stop, and the display will return to the Drum Kit & Song display.

* You can also stop recording by pressing the [START/S] button.

● **When the Record Mode is set to Overwrite (“Ovr”).**

The following display will appear while recording (only displayed, cannot be changed).

The measure number currently being recorded.

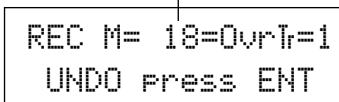

The song being recorded will continuously repeat until the [START/S] button is pressed.

When the song reaches the end of the last measure, it will automatically start again from the beginning and new data will be added to the track’s previous data.

When the record mode is set to Overwrite (“Ovr”), press the [SAVE/ENT] button while recording to “undo” (do again) the record operation. The data previously recorded from the beginning of the song, up until the [SAVE/ENT] button was pressed, will revert to the data originally present.

● **How the “Undo” Works (an example)**

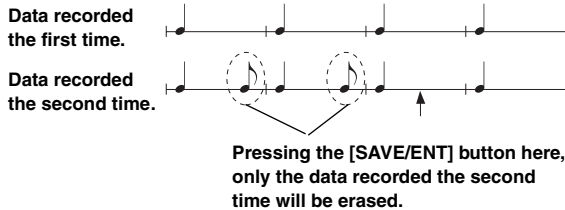

Press the [START/S] button to stop recording, the display will return to the Drum Kit & Song display.

❗ **If the power is cut off during recording, all user song data may be lost. Please use caution.**

4. Listen to the Song

Press the [START/S] button, playback of the song you just recorded will start from its beginning. You can also change the drum kit and playback the song with a different kit.

→ P. 48 [2. Program Change, Bank Select]

5. Redo the Recording

To record again, use the following procedure to clear previously recorded data in the track, then try recording again.

• **To clear song data (both tracks 1 and 2).**

Double-click the [SONG] button, the Clear Song display, shown below, will appear.

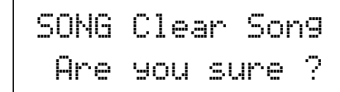

Press the [SAVE/ENT] button, all of the data in the currently selected song will be cleared.

• **To clear data from one track.**

Double-click the [SONG] button, after the Clear Song display, shown above, appears press the [PAGE▲] button 2 times. The Clear Track display shown below will appear.

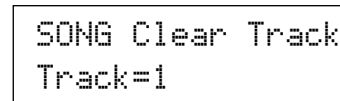

Use the [VALUE-]/[VALUE+] buttons to set the number of the track you want to clear, then press the [SAVE/ENT] button, “Are you sure ?” will appear in the display. Press the [SAVE/ENT] button again, all of the data in the currently assigned track of the selected song will be cleared.

6. Record One More Track

In the same manner, one more track can be used to record. However, the number of measures cannot be changed.

7. Give the Song a Name

On the display, “no name” will appear for the song name. Change the name to an original name.

Press the [SONG] button to display the song mode, use the [PAGE▲]/[PAGE▼] buttons to select the Song Name setting display shown below.



Use the [SEL◀]/[SEL▶] buttons to move the flashing cursor to the character you want to change, then use the [VALUE-]/[VALUE+] buttons to select the desired character.

The available characters to choose from are listed below. (in order)

- Space
- !"#\$%&'()*+,-.0123456789:;<=>?@
- ABCDEFGHIJKLMNPOQRSTUVWXYZ[^_`
- abcdefghijklmnopqrstuvwxyz{|}~

A maximum of 8 characters can be used for the song name.

If the power is switched off, the completed song will be stored.

Create Your Own Original Drum Kit

You can assign voices you like to each of the pads, and set the tuning (pitch), voice, decay, reverb, etc. to create your own original drum kit.

1. Select the Drum Voice

First, select a drum voice for the kit you want to create. Let's try assigning a snare drum voice.

It doesn't matter what drum kit you select (the drum kit that is created will be saved to a user drum kit (No. 49-80)).

1-1. Select a Snare Drum for the Input Source.

Press the [VOICE] button and the display for selecting the Drum Voice will appear.

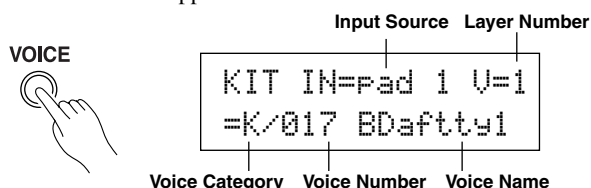

Use the [SEL◀]/[SEL▶] buttons to move the flashing cursor to the input source position, then use the [VALUE-]/[VALUE+] buttons to select "pad 2". This means that the snare pad input that is connected to trigger input jack 2 SNARE is selected. The value "U=1" indicates that the layer number=1. Two voices can be delivered (2 layer) with one input source (trigger input). In this case, you will have to assign which voice will be used here.

1-2. Select the Drum Voice Category.

Next, decide the drum voice category.

The drum voice category is the same category that was used in the Metronome Click Voice (P. 19).

For this example, let's select "s: Electric Snare".

Use the [SEL◀]/[SEL▶] buttons to move the flashing cursor to the voice category position, then use the [VALUE-]/[VALUE+] buttons to select "s".

A "*" mark will appear between "KIT" and "IN". This is to let you know that data in the currently selected drum kit has changed.

1-3. Select the Drum Voice.

Next, let's select a drum voice.

Using the same procedure you used when you changed the metronome click voice (P. 19), press the [SEL▶] button to move the flashing cursor to the Voice Number position, then use the [VALUE-]/[VALUE+] buttons to assign the drum voice. For this example, let's select "014 Dance01".

```
KIT *IN=pad 2 U=1
=s/014 Dance01
```

With this, we have assigned a drum voice for the kit you want to create.

Now, let's try to edit this drum voice in several ways and create your own original snare drum voice.

2. Try Changing the Volume

Let's change the volume of the drum voice that is delivered when the pad is hit. Adjust the volume balance between the other pads. Press the [PAGE▼] button and the following display will appear.

```
KIT*IN=pad 2 U=-
Vol= 120 Pan= C
```

Volume Pan

Use the [SEL◀]/[SEL▶] buttons to move the flashing cursor to the volume level position, then use the [VALUE-]/[VALUE+] buttons to set the volume level.

* "U=-" appears when the drum voice is not a 2 layer voice.

HINT Press the [VOICE] button to monitor the voice just as if the pad were hit.

3. Try Changing the Pan

Using the same display, you can change the pan setting for the drum voice.

According to this setting you can move the position of the currently selected drum voice within the stereo field as follows: "L64" (left side) - "C" (Center) - "R63" (right side).

Press the [SEL▶] button to move the flashing cursor to the pan level position, then use the [VALUE-]/[VALUE+] buttons to set the pan value.

4. Try Changing the Tuning (Pitch)

Let's try and change the tuning (pitch) of the drum voice.

Press the [PAGE▼] button and the following display will appear.

```
KIT*IN=pad 2 U=-
Tune C= 0 F= 0
```

Tuning in half-step increments Finer tuning

Use the [SEL◀]/[SEL▶] buttons to move the flashing cursor to the "C" or "F" position, then use the [VALUE-]/[VALUE+] buttons to set the pitch of the voice.

Tuning for "C=" is in increments of a half-step, tuning for "F=" is in steps of approximately 1.17 cents.

5. Try Changing the Decay (the length of time it takes for the voice to fade)

Let's try and change the voice's decay (the length of time it takes for the voice to fade).

Press the [PAGE▼] button twice and the following display will appear.

```
KIT*IN=pad 2 U=-
Decay=+ 8 Fc= 0
```

Decay Filter Cutoff Frequency

Use the [SEL◀]/[SEL▶] buttons to move the flashing cursor to the decay value position, then use the [VALUE-]/[VALUE+] buttons to set the amount of decay.

A + (plus) value will produce a faster decay.

6. Try Changing the Character of the Voice (Filter Setting).

Using the same display you can set the Filter Cutoff Frequency. Try to change the character of the voice (the brightness of the voice).

Press the [SEL▶] button to move the flashing cursor to the "Fc=" position, then use the [VALUE-]/[VALUE+] buttons to set the value.

A + (plus) value will produce a brighter sound.

7. Try Adjusting the Volume Balance of the 2 Layer Voice.

If the selected drum voice is made with 2 layers (1 drum voice made with 2 voice waves), the volume balance can be adjusted between the 2 waves.

Press the [PAGE▲] button and the following display will appear.

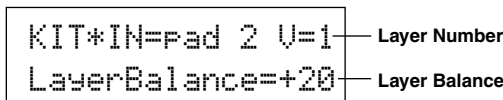

Use the [SEL◀]/[SEL▶] and [VALUE-]/[VALUE+] buttons to select the layer number.

* If the assigned voice is not made of 2 layers this setting is not valid.

Press the [SEL▶] button to move the flashing cursor to the layer balance position, then use the [VALUE-]/[VALUE+] buttons to set the layer balance value.

8. Adjust the Amount of Reverb.

Let's try and adjust the amount of reverb effect that is applied to the voice.

Use the [PAGE▲]/[PAGE▼] buttons to select the display shown below.

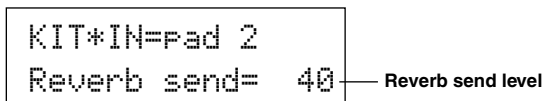

Use the [SEL◀]/[SEL▶] buttons to move the flashing cursor to the reverb send level position, then use the [VALUE-]/[VALUE+] buttons to set the value.

Large values will increase the amount of reverb applied to the voice, "0" will produce no reverb.

* This setting is the reverb level for each input source. The overall reverb level for the drum kit is set in [5-2. Drum Reverb Send] (P. 47)

9. Adjust the Balance Between Layer 1 and 2.

If you have used a 2 layer voice in the voice you just created, adjust the balance between the voices by adjusting the volume of each voice.

* You can select the conversion curve for 2 voices.
→ Drum Kit Edit Mode [2-1. Cross Fade] (P. 43)

10. Save the Voice You Have Created

Let's save the drum voice you created to the DTXPRESS' memory. Drum kit numbers "49" - "80" (these are called user drum kits) are used for saving individual drum kits.

Press the [SAVE/ENT] button, the following display will appear.

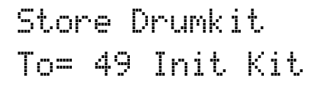

Use the [VALUE-]/[VALUE+] buttons to set the drum kit number ("49" - "80") for saving your drum kit to.

Press the [SAVE/ENT] button, "Are you sure?" will appear on the display asking for confirmation.

* To cancel the save operation, press the [VALUE-] button.

Press the [SAVE/ENT] button again, the save operation will be carried out, then "Complete!" will appear. After "Complete!" appears, the display will return to the Drum Kit & Song setting display.

11. Give Your Drum Kit a Name

The completed drum kit will still have the original drum kit's name.

Press the [VOICE] button to enter the Drum Kit Voice Edit mode, then press the [PAGE▼] button to display the Drum Kit Name setting display shown below. With the same procedure you used when you made a Song, give your drum kit an original name. (P. 21)



Now the drum kit with the original snare drum you created is complete.

Use the same procedure to create drum voices for the other pads (input source) and create a complete drum kit that is all your own.

HINT

The DTXPRESS also has keyboard voices that comply with the GM System Level 1. So, not only drum voices, but piano, guitar, bass, strings, brass, reeds, effect, etc. can be delivered when the pad is struck.

To use keyboard voices with the pads first, change the pad's MIDI channel to any channel other than "10" (P. 42 [1-7. Channel, Gate Time]), then select the MIDI note number of the voice you want to use in (P. 42 [1-6. Note Number])

* If the [2-5. Key Off Enable] (P. 44) is set to "disable", some voices may sound continuously. In this case, press the [SHIFT] + [VOICE] buttons to stop voices sounding.

Getting More Out of Your DTXPRESS

There is much more to the DTXPRESS than what we have covered so far. With a full understanding of these functions you can get the most out of the DTXPRESS.

■ Factory Set

The internal settings of the DTXPRESS will be returned to their factory preset condition.

→ Utility Mode [1-6. Factory Set] (P. 53)



If the factory set operation is carried out, data for the User Drum Kit, User Trigger Setups and User Songs will be lost.

■ Functions related to connections and input source (pads)

- Drum kits can be selected by hitting a pad. For example, with an optional Yamaha Bar Pad BP80 connected to the trigger input jack 9/10, you can hit the left bar pad to decrease the value of the drum kit number by 1. Likewise, hitting the right bar will increase the value of the drum kit number by 1.

When the function described above is used in any drum kit

→ P. 38 [2-1. Increment/Decrement]

When the function described above is used in a specified drum kit.

→ P. 44 [2-6. Function]

- A hi-hat controller connected to the trigger input jack 1 KICK can be used as a KICK pedal.
→ P. 36 [1-1. Pad Type]
- Several methods are available for adjusting the sensitivity of pads and drum triggers.

To automatically set suitable settings for pads and drum triggers connected to the DTXPRESS

→ P. 36 [1-1. Pad Type]

To greatly modify the sensitivity,

→ Change the INPUT ATTENUATION switch on the rear panel. (P. 10)

For minor adjustments to the sensitivity,

→ P. 36 [1-2. Gain, Minimum Velocity]

- Set the sensitivity of the hi-hat controller connected to the HI HAT CONTROL jack.
→ P. 47 [5-3. Hi-Hat Sensitivity]
- Set the point at which the hi-hat controller “closes” the hi-hat and the amount of time it takes to detect a foot splash
→ P. 53 [1-5. Hi-Hat Offset]
- Eliminate cross-talk (mixed input signals between the jacks)
→ P. 37 [1-4. Self Rejection/Rejection]
→ P. 37 [1-5. Specified Rejection]
- Eliminate double-triggers (2 sounds played at the same time)
→ P. 37 [1-4. Self Rejection/Rejection]
- Set the velocity curve that determines the relationship between the strength that the pad is hit and the volume that is produced
→ P. 37 [1-3. Velocity Curve]

- Switch the signals between trigger input jacks 1 and 9/10
→ P. 38 [2-2. Input Exchange]
- Copy trigger setup data from one trigger input jack’s setup to another
→ P. 37 [1-6. Trigger Setup Copy]
- Temporarily prohibit reception of trigger signals from all pads connected to the DTXPRESS
→ P. 52 [1-2. Trigger Bypass]

Switch the trigger bypass function (above) ON/OFF from a pad.

→ P. 44 [2-6. Function]

■ Set the Reverb

The DTXPRESS is equipped with a digital reverb section.

- Set the reverb type and reverb time for each drum kit
→ P. 45 [3-1. Reverb Type, Time]
- The following three methods can be used to set the amount of reverb.

Adjust the reverb level for the voice delivered by the pad of each input source,

→ P. 43 [2-2 Reverb Send]

Adjust the reverb send level for the entire drum kit,

→ P. 47 [5-2. Drum Reverb Send]

Adjust the DTXPRESS’ overall reverb send level,

→ P. 45 [3-2. Reverb Master Return]

Adjust the amount of reverb for each drum kit in the user drum map

→ P. 60 [5-6. Reverb Send]

- Bypass the reverb circuit (no reverb).
→ P. 59 [4-4. Reverb Bypass]

■ Settings related to the Drum Voice

- Set the cross fade between voice layers 1 and 2.
→ P. 43 [2-1. Cross Fade]
- Set the rim voice to simultaneously trigger the pad voice when stereo pads are used.
→ P. 45 [2-8. Rim to Pad]
- Set the alternate group and key assign mode for voices that are delivered simultaneously.
→ P. 43 [2-3. Alternate Group, Key Assign Mode]
- Set the key ON/OFF that is transmitted when the pad is hit.
→ P. 44 [2-4. Hold Mode]
- Set whether to recognize or not key off messages.
→ P. 44 [2-5. Key Off Enable]

- Set the volume of the entire drum kit.
→ P. 47 [5-1. Volume]
- Create an original drum kit.
→ P. 59 [5. MAP (Drum Map Group)]

■ Settings Related to the Tone Generator

- The following settings will have an effect over the entire tone generator.
Equalizer (adjust the tone quality), Tuning, Volume, Reverb Bypass
→ P. 58 [4. TG (Tone Generator) Group]

■ Settings Related to the Song

- Automatically switch the main song when the drum kit is switched.
→ P. 47 [5-4. Song Select]
- Control the simultaneous playback (start/stop) of up to 3 songs by hitting the pad.
→ P. 44 [2-7. Pad Song]
- Edit the following parameters in song sequencer data
Tempo, Repeat Playback, Program Change, Bank Select, Volume, Pan, Song Copy, Quantize, Clear Track, Merge Track, Clear Song and Song Name
→ P. 48 [Song Job Mode]
- Playback the song at the set tempo, even when the song is switched.
→ P. 58 [3-7. Use Tempo]

■ Other Functions

- Along with triggering voices the pads can be used for a variety of control functions.
Pad song playback/stop, metronome's click voice ON/OFF, switch drum kits, trigger bypass ON/OFF and playback/stop of the main song.
→ P. 44 [2-6. Function]
- Assign pads (trigger input source) in the Trigger Setup Edit mode and Drum Kit Voice Edit mode simply by hitting the pad.
→ P. 52 [1-1. Learn Mode]
- Adjust the volume of the cymbal, drum and other instruments using the ACCOMP. VOL. knob and CLICK VOL. knob.
→ P. 52 [1-3. Volume Mode]
- Display the page that was previously used in the Trigger Setup Edit mode and Drum Kit Voice Edit mode.
→ P. 52 [1-4. Jump to Recent Page]

■ Using MIDI

The DTXPRESS is equipped with MIDI IN/OUT jacks and a TO HOST jack. These jacks are used to exchange data between an external MIDI device/computer and the DTXPRESS. The MIDI data format is used.

About MIDI

MIDI (Musical Instrument Digital Interface) is a world standard that provides a means to connect instruments and computers and allow them to transmit and receive performance and other data. This standard allows computers and instruments of different makers and types to communicate.

Using MIDI the DTXPRESS can perform the following operations. Refer to the [Connecting a MIDI Device] section (P. 12) for more information on connecting external MIDI devices.

● Bulk Dump/Bulk In

Data for each of the settings in the DTXPRESS can be transmitted to an external MIDI device or computer (Bulk Dump). When connected to the DTXPRESS, a device equipped with a "save" function, such as the Yamaha MDF3, etc., can be used to backup your data and create a library with.

Also, the data saved in an external device can be transmitted back to the DTXPRESS (Bulk In).

● Synchronized Playback with External MIDI Devices

When two MIDI devices that use tempo information such as a sequencer, etc. are connected, one device must play along with the other (sync) using tempo information (clock) transmitted by the master device.

Playback of an external sequencer's data can be synchronized with the DTXPRESS' song and metronome click. Also, playback of the DTXPRESS' song can be synchronized to an external sequencer.

● Transmit and Receive MIDI Data

- The DTXPRESS' tone generator can be driven by MIDI song data (sequence data) transmitted from an external MIDI device. This song data can be recorded along with your performance on the DTXPRESS.
- The DTXPRESS' drum kits can be switched and song playback can be controlled from an external MIDI device.
- Hi-hat controller information can be transmitted via MIDI.

A variety of other MIDI information can also be transmitted and received.

Refer to the [Drum Kit Voice Edit Mode] (P. 39), [Utility Mode] (P. 51), [MIDI Data Format], (P. 80) etc. for more information.

Getting More Out of Your DTXPRESS

■ Connecting a Computer

The following two methods are available for connecting the DTXPRESS to a computer.

1. Directly connect the computer's serial port to the DTXPRESS' TO HOST jack.
2. Connect the DTXPRESS' MIDI IN jack to the computer through a MIDI interface.

1. Directly connect the serial port to the TO HOST jack.

The method used for connect and transferring signals between a computer and the DTXPRESS is basically the same, no matter what type of computer is used.

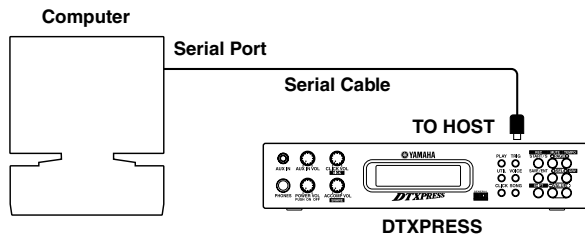

Use a cable to connect the devices and set the **HOST SELECT SWITCH** according to the type of computer serial port and clock used. Carefully read the instructions on the right side of this page and select an appropriate cable for the type of computer you are using.

HINT The input signal from the TO HOST jack will be transmitted to the DTXPRESS' tone generator and sequencer, and simultaneously transmitted to the DTXPRESS' MIDI OUT jack. At this time, only message for the port number that is set in the Utility mode's [2-10. Host Thru Port] (P. 56) will be sent to the MIDI OUT jack.

The signal from the tone generator and sequencer is merged with the signal from the MIDI IN jack and output to the TO HOST jack.

2. Connect the MIDI IN Jack to a MIDI Interface

- If you are using a computer equipped with a MIDI interface, connect the MIDI OUT jack on the computer to the MIDI IN jack on the DTXPRESS. Set the HOST SELECT switch to the "MIDI" position.
- If you are using a Macintosh series computer with an external MIDI interface, connect the MIDI interface to the computers RS-422 jack (modem or printer port), connect the MIDI OUT jack on the interface to the MIDI IN jack on the DTXPRESS. Set the HOST SELECT switch to the "MIDI" position.

* When the HOST SELECT switch is set to the "MIDI" position, the transmission and reception via the TO HOST jack is ignored.

Computer Connecting Cables

● Mac

Apple Macintosh Peripheral cable (M0197).
Maximum length 2 meters.

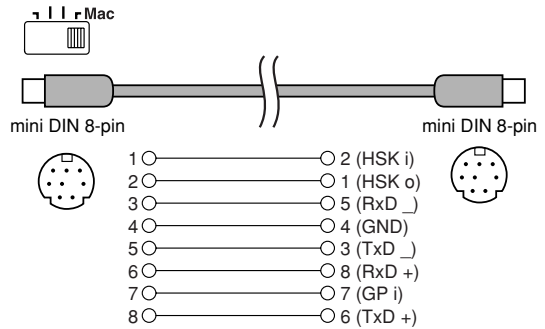

● PC-1

8-pin MINI DIN to D-SUB 25-pin cable.
If your PC-1 type computer has a 9-pin serial port, use the PC-2 type cable. Maximum length 1.8 meters.

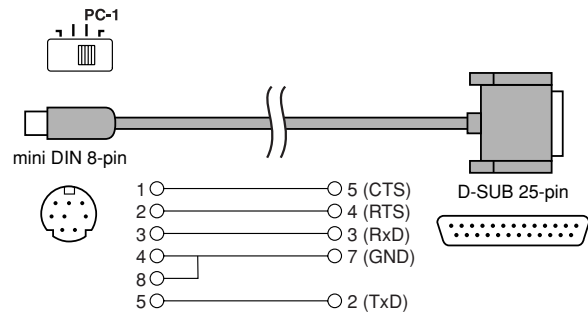

● PC-2

8-pin MINI DIN to D-SUB 9-pin cable.
Maximum length 1.8 meters.

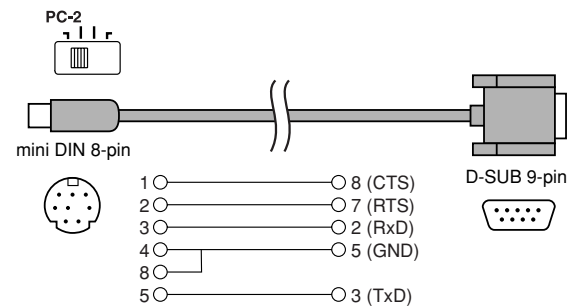

Reference

This section describes each function of the DTXPRESS in detail. You can use it like a dictionary to look up the functions you can't understand. Each mode is listed in the same order as they are displayed in the DTXPRESS.

The Table of Contents (P. 6) and Index (P. 85) will assist in locating functions and lists.

DTXPRESS Internal Makeup	28
Drum Kit Play Mode	30
About the Song	32
Trigger Setup Edit Mode	35
Drum Kit Voice Edit Mode	39
Song Job Mode	48
Utility Mode	51

DTXPRESS Internal Makeup

■ The DTXPRESS' Internal Signal Flow

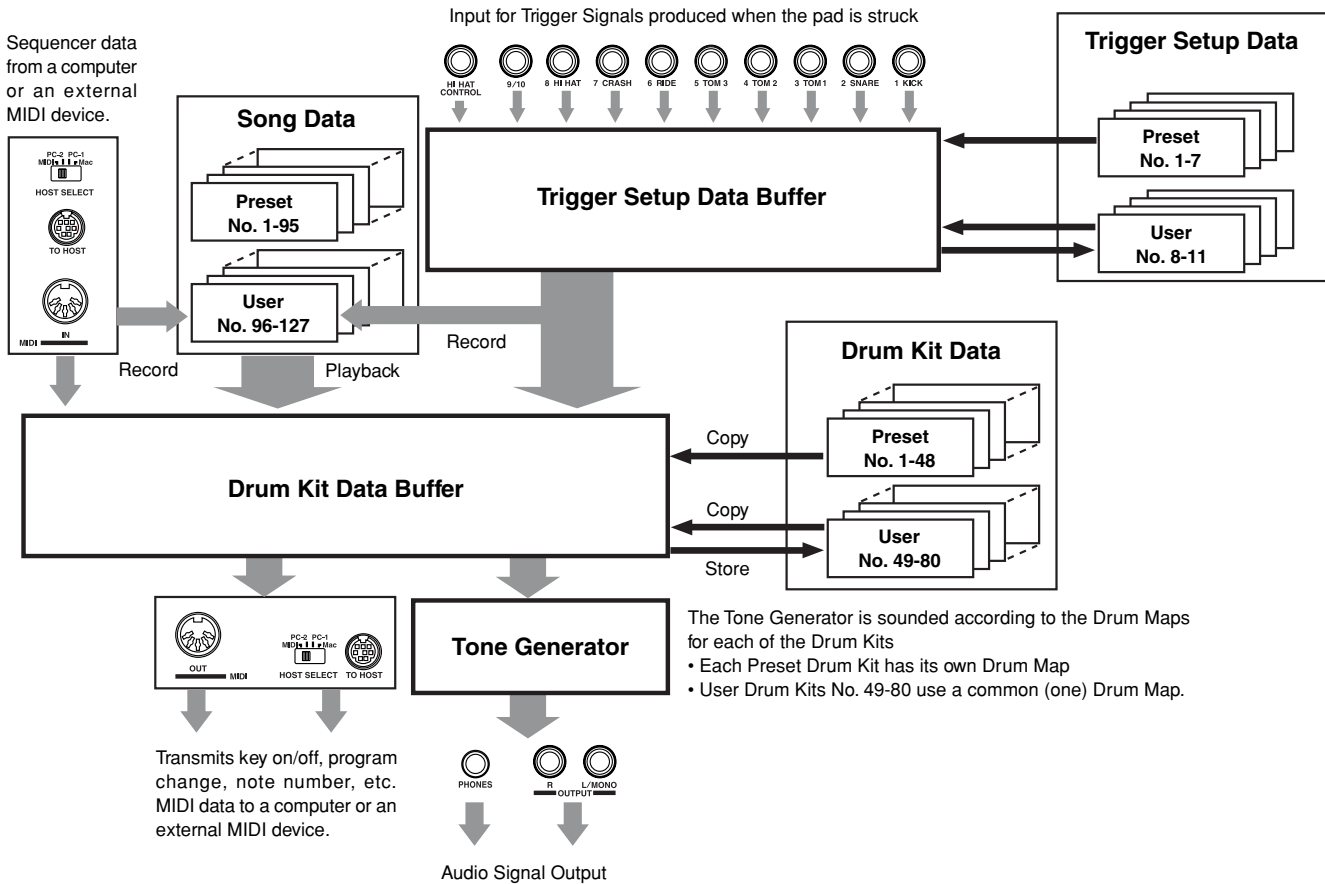

● Pad Data Signal Flow

In order for the DTXPRESS to effectively manage trigger signals transmitted from the pads connected to the Trigger Input Jacks (1 KICK, 2 SNARE, ... 9/10) and the HI HAT CONTROL jack, trigger signals are adjusted to a suitable signal in the Trigger Setup Buffer using the **Trigger Setup**.

Signals transmitted from the Trigger Setup Buffer will enter the Drum Kit Buffer.

In the Drum Kit Buffer, the **Drum Kit** is set as to what voices will be used and how voices will be delivered for each of the Trigger Input Sources. The **Tone Generator's Voices** will be produced according to these settings and its audio signal will be transmitted to the OUTPUT jacks and PHONES jack.

● Trigger Setup Data

This mode is used for adjusting the trigger input, from pads and trigger sensors connected to the Trigger Input Jacks, to a suitable signal the sensitivity and velocity curve settings. (The signals characteristics will change according to the strength of the hit.) Also, cross-talk and double-trigger can be effectively eliminated with the settings available here.

Along with 7 preset trigger setups (No. 1-7), there are another 4 user trigger setups (No. 8-11) available for storing original setups. After selecting a trigger setup for use, the data will be copied to the Trigger Setup Data Buffer where the copied data will be used in performance. (Refer to the illustration above.)

Setup data can be freely changed in the Trigger Setup Edit mode and saved, if necessary, to the User Trigger Setup's memory (No. 8-11).

● Drum Kit Data

This mode is used for setting drum kit voices, for example, assign a voice to each pad (trigger input source) used in the drum kit and perform settings such as selecting the voice, tuning, reverb level, etc.

The DTXPRESS has 48 preset (No. 1-48) drum kits and another 32 user (No. 49-80) drum kits that are used for saving original drum kits created by the user.

As in the Trigger Setup, the selected drum kit's data will be copied to the Drum Kit Data Buffer where the copied data will be used in performance. (Refer to the illustration above.) This Drum Kit data can be freely changed in the Drum Kit Voice Edit mode and saved, if necessary, to the User Drum Kit's memory (No. 49-80).

● **Tone Generator**

The DTXPRESS' tone generator contains a total of 910 drum and percussion voices.

Preset Drum Kits use an exclusive Drum Kit Map for each kit in which voices for the kit are assigned to individual MIDI note numbers.

The User Drum Kit uses one drum map (User Drum Map) that is common for all drum kit numbers 49-80. The Utility mode's [5. Map (Drum Map)] group can be used to assign voices to each MIDI note number (0-127) and edit the drum kit.

Along with the DTXPRESS' drum and percussion voices, the DTXPRESS possesses a variety of keyboard voices (128 voices) that are based on the GM System Level 1. It is possible to deliver piano and brass voices by hitting the pad and playback songs with the internal sequencer or from external sequencer data. A maximum of 32 voices can be delivered simultaneously.

● **Song Data**

The DTXPRESS contains 95 preset songs (No. 1-95) that consist of not only drum parts but also keyboard, brass, etc., accompaniment parts.

You can enjoy the songs as they are or mute the song's drums or a single drum voice (snare drum, etc.) and play along with the drum. Also, you can record your performance to the User Song memory (No. 96-127). Each song consists of two tracks and each track can include data for MIDI channels 1-16.

● **MIDI/TO HOST Jacks**

All drum kit setting data and sequencer data are managed with a MIDI data.

By connecting the DTXPRESS' MIDI OUT/IN jacks to the MIDI IN/OUT jacks on an external MIDI device, MIDI data can be exchanged. The TO/HOST jack is used to transmit and receive MIDI data from a computer.

According to the MIDI data transmitted from an external MIDI device or computer connected to the DTXPRESS, drum kits can be switched, the song can be controlled and the tone generator can be sounded freely.

For example, song data (sequencer data) transmitted from an external sequencer to the DTXPRESS' MIDI IN jack can be used to play the voices produced by the DTXPRESS' internal tone generator. You can use the DTXPRESS to play along with these songs and record both external sequencer and DTXPRESS parts.

Also, MIDI data produced when the DTXPRESS can be transmitted to an external MIDI device and/or computer. Playing the DTXPRESS in this configuration allows you to trigger the external tone generator's voices and when a drum kit is switched, have the external MIDI keyboard's voice change as well. The DTXPRESS' data can be stored to, as well as retrieved from an external MIDI device.

■ **Basic Operations for Data Setting**

● **Enter the Modes**

Press each Mode button.

Double-click a button to jump directly to the specified page the mode you want to enter.

- **Drum Kit Play Mode** [PLAY]
- **Trigger Setup Edit Mode** [TRIG]
- **Utility Mode** [UTIL]
- **Drum Kit Voice Edit Mode** [VOICE]
- **Song Job Mode** [SONG]



● **Page Navigation**

Press the [PAGE▲] button to move to the previous page, the [PAGE▼] button to move to the next page. Hold the button to scroll through the pages.



● **Select the Parameter**

The flashing parameter on the display is specified for setting.

- Use the [SEL◀] and [SEL▶] buttons to move the cursor (the flashing character or symbol).
The [SEL◀] button moves the cursor to the left while the [SEL▶] moves the cursor to the right.
- When there is only one parameter on the display, the [SEL◀]/[SEL▶] buttons will not operate.



● **Change the setting**

The setting (value) of flashing parameter on the display can be changed.

- The [VALUE-] and [VALUE+] buttons are used to set parameter values.
When setting values, press the [VALUE-] button to decrease (minus) the value, press the [VALUE+] button to increase (plus) the value. Holding the button will continue to decrease/increase the value.
Hold the [VALUE-] and press the [VALUE+] button will decrease the value by 10. Continue to hold both buttons and the value will continue to decrease.
Hold the [VALUE+] button and press the [VALUE-] button to increase the value by 10. Continue to hold both buttons and the value will continue to increase.



Drum Kit Play Mode

This mode enables you to play the DTXPRESS drum voices by hitting the pads (or drums with trigger sensors attached) connected to the DTXPRESS.

The DTXPRESS automatically enters this mode when the power is switched on.

You can select and play from 48 preset drum kits and 32 user kits.

Also, the drum kit, trigger setup and song specified in this mode will be selected and ready for editing when the Drum Kit Voice Edit, Trigger Setup Edit and Song Job modes are entered.

■ Entering the Drum Kit Play Mode

Press the [PLAY] button on the front panel.

Once the Drum Kit Play mode is entered, the Drum Kit & Song display shown below will appear.

PLAY



```
KIT =1 Acoustic
SONG=1 Latinia
```

■ What's in the Drum Kit Play Mode

The Drum Kit Play mode contains the three setting displays shown below.

1. Drum Kit & Song (P. 30)

This display is used for selecting the drum kit and song.

2. Trigger Setup & Tempo (P. 30)

This display is used for selecting the trigger setup and song settings.

3. Song & Mute (P. 31)

This display is used for selecting the song and specifying the drum mute during the song.

Procedure

1. Press the [PLAY] button to enter the drum kit play mode.
2. Use the [PAGE▲]/[PAGE▼] buttons to select the page you want to set.
3. Use the [SEL◀]/[SEL▶] buttons to move the cursor to the parameter you want to set. The parameter will flash.
4. Use the [VALUE-]/[VALUE+] buttons to set the parameter's value.

HINT Press the [SHIFT]+[PAGE▼] buttons, in any Drum Kit Play mode display, to jump to the Trigger Setup & Tempo display with the cursor moved to tempo value.

1. Drum Kit & Song

This display is used for selecting the drum kit and song.

```
KIT =1 Acoustic
SONG=1 Latinia
```

① KIT (Drum Kit)

[Range] 1-80

Selects the drum kit. The drum kit number and drum kit name will be displayed. Preset kits are numbered 1-48 and user kits are numbered 49-80.

When a pad is hit, the selected drum kit voice will be delivered. Also, this drum kit will be specified for editing when the Drum Kit Voice Edit mode is entered.

* Once a setting is changed in the Drum Kit Voice Edit mode, "*" will appear between "KIT" and "=" until the data is stored.

* Refer to the [Preset Drum Kit List] (P. 72)

② SONG

[Range] 1-127

Selects the song. The song number and song name will be displayed. Preset songs are numbered 1-95 and user songs are numbered 96-127.

The selected song will playback when the [START/S] button is pressed.

* When the rhythm mute ([SHIFT]+[PAGE▲]) is applied, the last letter of the song name will be "R".

* Refer to [About the Song] (P. 32).

* Refer to the [Preset Song List] (P. 79).

2. Trigger Setup & Tempo

This display is used for selecting the trigger setup and song settings.

HINT Press the [SHIFT]+[PAGE▼] buttons, in any Drum Kit Play mode display, to jump to the following display with the cursor moved to tempo value.

```
TRIG =1 Medium
J=110=---= 4/4=J
```

① TRIG (Trigger Setup)

[Range] 1-11

Selects the trigger setup to be used. The trigger number and trigger name will be displayed. Presets are numbered 1-7 and user setups are numbered 8-11.

* For more information on the preset trigger setup, refer to the [Trigger Setup List] (P. 79).

* Once a setting is changed in the Trigger Edit mode, "*" will appear between "TRIG" and "=" until the data is stored.

② J (Tempo)

[Range] 30-300, ext

Sets the playback tempo for the song.

When the DTXPRESS is controlled by an external sync, “ext” will be displayed.

* The external sync setting is found in [3-6. Sync Mode] (P. 57).

③ Repeat Playback

[Range] —, rp

Sets the repeat playback (repeat continuously from the beginning to the end of the song) of the song.

When this parameter is set to “rF”, the song will repeat playback. When this parameter is set to “—”, the song will playback normally.

④ Beat

[Range] 1/4-8/4, 1/8-16/8, 1/16-16/16

Sets the beat of the song (metronome).

⑤ Metronome Note Value

[Range] When the beat ④ is set to 3/8, 6/8, 9/8, 12/8, 15/8, the click tempo will be set to

↓ quarter note, ↓ eighth note, ↓ sixteenth note.

When the beat ④ is set to any value that is not listed above, the click tempo will be set to

↓ quarter note, ↓ quarter note (triplet),

↓ eighth note, ↓ eighth note (triplet),

↓ sixteenth note, ↓ sixteenth note (triplet).

Use the note values to set the click tempo of the metronome.

3. Song & Mute

This display is used for selecting the song and specifying the drum mute during the song.

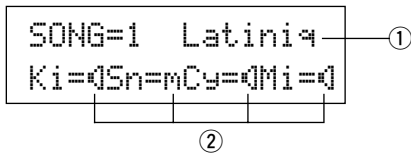

① SONG

[Range] 1-127

Selects the song. The song number and song name will be displayed.

Press the [SONG] button to start playback of the selected song.

* This song select operation is the same as in [1. Drum Kit and Song]. The only difference is whether the display will switch or not when the Groove Check is used.

② Drum Mute

[Range] m (mute; Does not produce sound), n (Produces sound)

Sets the type of drum voice to be muted. The 4 types of voices that can be muted are Ki (kick), Sn (snare), Cy (cymbal) and Mi (others).

* Drum voice types

Drum voices are divided into many groups (categories) in accordance with the type of sound i.e. kick, snare, etc. For more information on Drum Voice categories, refer to the [Drum Voice List] (P. 68).

Drum Voice Category Mute Classification

K, k Ki (kick)

S, s Sn (snare)

C, H Cy (cymbal)

T, t, P, E, e, L, m Mi (others)

HINT Since drum voices for pads (triggers) are not muted you can, for example, mute the snare voice of a song and practice the snare part along with song playback (the snare voice is delivered when the pad is hit).

Groove Check Function

Function

As you play the pads along with a song, the DTXPRESS will compare your performance with its song clock and let you know how accurate your timing is.

Display

In the Drum Kit Play mode (from any display) press the [SHIFT]+[SEL▶] (GRV) buttons.

* The Groove Check function will quit when song playback is stopped.

* The top line of the original page is displayed as is.

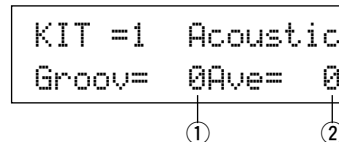

Setting

① Groov (Groove)

[Range] -48 to 0 to +48

The difference in the timing of each stroke on the pad is displayed.

If the timing of the stroke is late compared to the just time, a minus value will be displayed. If your timing is early, a plus value will be displayed. If you timing is perfect, “0” will be displayed.

② Ave (Average)

[Range] -48 to 0 to +48

This function displays the average value of your timing accuracy after the Groove Check function is switched ON.

This function checks your performance on the entire drum set and can check your performance on one song. The information shown in the display is the same as in ① Groov.

* To reset the data, press the [SHIFT]+[SEL▶] buttons twice.

About the Song

The DTXPRESS can internally store data for a maximum of 127 songs that can be played back freely.

Song numbers 1-95 are preset songs and song data in those songs cannot be changed or rewritten.

Song numbers 96-127 are user songs that can be used to record new performance data and also edit song data in.

■ Song Makeup

The Song consists of two sequencer tracks plus header data.

Header data is written at the front of the song and holds information related to the song's tempo, beat, program numbers (voice) for each MIDI channel and volume, etc. Header data is read every time the song is played from the beginning.

Both tracks possess data for MIDI channels 1-16 (except system exclusive data).

During song playback, the sequencer data that is written in the song will be transmitted to the DTXPRESS' tone generator to produce the song.

■ Main Song and Pad Song

Up to four songs can be played back simultaneously.

The song that is selected in the Drum Kit Play mode (P. 30) is called the Main Song. Pressing the [START/S] button will start playback of this song.

The remaining three songs are called Pad Song(s). These songs are played back according to the trigger input (hitting a pad).

■ Metronome

The sequencer produces the metronome.

The metronome can be used either alone or with the Song.

Press the [CLICK] button, in any mode, to start the metronome. The metronome's tempo, voice, etc. are set in the Utility mode [3. Sequencer Group] (P. 56).

Song Playback

■ Main Song Playback

• Select a Song

1. Press the [PLAY] button to enter the Drum Kit Play mode. Use the [PAGE▲]/[PAGE▼] buttons to display either of the displays shown below (Drum Kit & Song or Song & Mute).

• Drum Kit & Song

```
KIT =1 Acoustic
SONG=1 Latinia
```

• Song & Mute

```
SONG=1 Latinia
Ki=0Sn=0Cy=0Mi=0
```

2. Use the [SEL◀]/[SEL▶] buttons to move the cursor to the "SONG=" position.
3. Use the [VALUE-]/[VALUE+] buttons to set the song number of the song you want to playback.

• Set the Tempo, Repeat Playback, Beat and Metronome

1. In the Drum Kit Play mode, use the [PAGE▲]/[PAGE▼] buttons to display the "Trigger Setup & Tempo" display shown below.

```
TRIG =1 Medium
J=120---= 4/4=J
```

2. Use the display shown above to set the Tempo, Repeat Playback, Beat and Metronome Note Value.

• Song Playback (Start/Stop)

Press the [START/S] button, in any display, to start playback of the song (main song).

During playback, press the [START/S] button to stop playback of the song. Press the [START/S] button again and the song will start playback from the beginning.

- * If the pad's function is previously set to the "Main Song Control" function (→ Drum Kit Voice Edit Mode [2-6. Function] P. 44), you can start/stop the main song by hitting the assigned pad.
- * During song playback, the [SONG] button's LED will light for a moment at the beginning of each measure.
- * During song playback, the song cannot be changed.
- * If the song's tempo or voices are irregular, re-select the song.

■ Pad Song Playback (Start/Stop)

To playback a Pad Song, hit the pad that is assigned to the Pad Song you want to playback. Hit the same pad during playback will stop the song. Hit the pad again to start the song from the beginning.

- * Before using, set the pad's function to "Pad Song Control" and assign a song to the pad (→ Drum Kit Voice Edit mode [2-6. Function], [2-7. Pad Song] P. 44).
- * The song can be played one measure at a time, each measure triggered with a stroke on the pad (→ Drum Kit Voice Edit mode [2-7. Pad Song] P. 44)
- * If the Pad Song's tempo or voices are irregular, re-select the Drum Kit.

■ Song Playback Functions

During song playback, the song can be repeated and volume levels for each instrument can be changed.

• Volume Control

With each of the knobs on the front panel, the following volume levels can be controlled.

- [ACCOMP VOL]: The volume of the accompaniment (excluding percussion voices).
- [SHIFT]+[ACCOMP VOL]: The volume of the snare drum.
- [CLICK VOL]: The volume of the metronome's click.
- [SHIFT]+[CLICK VOL]: the volume of the bass drum.

If the Utility mode's [1-3. Volume Mode] (P. 52) is set to "live", the following volume levels can be controlled.

- [ACCOMP VOL]: The volume of the snare drum.
- [SHIFT]+[ACCOMP VOL]: The volume of the cymbal.
- [CLICK VOL]: The volume of the bass drum.
- [SHIFT]+[CLICK VOL]: The volume of the other drum instruments (excluding snare, bass drum, cymbals and the metronome's click).

• Set the Metronome

The voice, pitch and MIDI note number of the metronome's click voice can be set. ([3-1. Click Voice] (P. 56), [3-2. Click Tune] (P. 57), [3-3. Click Note Number] (P.57))

• Count Function

If the Utility mode's [3-5. Count Switch] (P. 57) is set to "ON" when the main song is played back, the first measure of the song will be preceded by a two measure count.

• MIDI Control by an External Device

- If the Utility mode's [3-4. MIDI Control] (P. 57) is set to "ON", playback of the main song can be controlled with system real-time messages (start/continue/stop) from the MIDI IN/TO HOST jack.
- If the Utility mode's [3-6. Sync Mode] (P. 57) is set to "ext" or "auto", the song playback can be synchronized to the clock of an external MIDI device.

• Rhythm Mute Function

When the [SHIFT]+[PAGE▲] buttons are pressed, the MIDI channels (usually channel 10) that are assigned to track 1 of the song and the drum voice will be muted (sound will not be delivered).

- * When the Rhythm Mute is applied, program changes will be ignored so the drum kit cannot be changed.

• Other Functions

- This function can set whether the song will playback according to the tempo information in the song or according to the tempo that is set when the song is switched. (→ P. 58 [3-7. Use Tempo])
- This function can set whether or not the click voice will be delivered automatically when the song is played back. (→ P. 58 [3-8. Click Mode])
- The metronome's click voice can be switched ON/OFF by hitting the pad. (→ P. 44 [2-6. Function])

Song Recording

Song recording lets you record data, produced as the drum kit is played, to the sequencer in real-time (one track at a time). All MIDI channels (1-16) are recorded simultaneously. Also, data produced by a MIDI keyboard connected to the MIDI IN jack can be recorded as well as sequencer data received via the MIDI IN/TO HOST jacks.

According to the recorded sequencer data (performance information), drum kits and voices can be changed during song playback. The songs that are recorded can be played back and edited in the same manner as preset songs (No. 1-48) with the Song Job mode.

Song Record Settings

Select the Song

1. Press the [PLAY] button to enter the Drum Kit Play mode, set the User Song number (No. 96-127) that you want to record to.

* Only User Songs (No. 96-127) can be used for recording. Preset Songs (No. 1-95) cannot be used for recording.

Set the Recording Conditions (Record Standby)

2. Press the [SHIFT]+[START/S] buttons, the record mode will be in standby. The following display will appear.

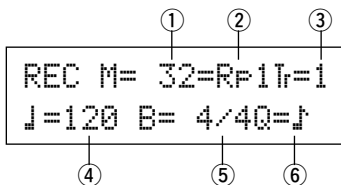

3. Use the display shown above to set the following recording conditions.

① M (the number of measures that will be recorded) [Range] 1-999

Assigns the number of measures that will be recorded. When there is data in the other track, the number of measures in that track will decide the length of the song and this length cannot be changed.

② Record Mode

Select the method of recording from the following.

Overwrite (Ovr): The record operation will be in a repeat mode. When the song reaches the end of the last measure, it will automatically start again from the beginning and new data will be added to the track's previous data.

Replace (Rpl): When the song reaches the end of the measure number assigned in "M" or the [START/S] button is pressed, recording will stop (the song will not repeat).

③ TR (Specify the Track for Recording)

Selects which track ("1" or "2") will be recorded.

④ J (Metronome Tempo) [Range] 30-300

Sets the metronome tempo for recording

⑤ B (Beat) [Range] 1/4-8/4, 1/8-16/8, 1/16-16/16

Sets the beat of the song (metronome) for recording.

⑥ Q (Quantize Accuracy)

[Range] J quarter note, J3 quarter note (triplet)
 J eighth note, J3 eighth note (triplet)
 J3 sixteenth note, J33 sixteenth note (triplet), no

The Quantize function* can be used when recording.

When set to "0", the Quantize function will not operate.

Quantize: This function is used to correct the timing of recorded MIDI note data. The accuracy of quantization is assigned by the note value.

* You can also use the Quantize function after recording is complete. (Song Job mode [5. Quantize] P. 49)

Record

4. Press the [START/S] button to start recording.

* If the Utility mode's [3-4. MIDI Control] (P. 57) is set to "on", the recording operation can be started with a system real time message (start) received via the MIDI IN/TO HOST jacks.

* When the track assigned for recording contains data and the [START/S] button is pressed, the error message "Data not Empty" will appear and the recording operation will not be carried out.

While the song is recording, the following display will appear (only displayed, cannot change).

When the Record Mode = Replace ("Rpl")

```
REC M= 5=RPT=1
Now Recording.
```

When the Record Mode = Overwrite ("Ovr")

```
REC M= 5=OvrT=1
UNDO Press ENT
```

• Next to "M=" the measure number currently being recorded is displayed.

• When the Record mode is set to "Ovr", press the [SAVE/ENT] button to "Undo" (do again) the record operation. Press the [SAVE/ENT] button while recording to start recording from the top of the song. The data previously recorded from the beginning of the song, up until the [SAVE/ENT] button was pressed, will revert to the data originally present.

Stop Recording

5. When the song reaches the end of the assigned measure number, recording will automatically stop and the DTXPRESS will return to the Drum Kit Play mode (Drum Kit & Song display).

* Recording can also be stopped anytime by pressing the [START/S] button.

* If the power is switched off while recording, all the data in the User Song may be lost. Please use caution.

Data recorded in the tracks cannot be overwritten. To record new data, use the Song Job mode's [6. Clear Track] (P. 50) or [8. Clear Song] (P. 50) operations to erase track data.

Trigger Setup Edit Mode

This mode contains various settings related to trigger input from the pads and trigger sensors that are connected to the DTXPRESS.

It allows you to adjust pad sensitivity and assign drum voices to each trigger input. Trigger Setup data consists of seven preset types (No. 1-7) and four original setup types (No. 8-11) for storing user setup data.

■ What you can do with the Trigger Setup Edit Mode

The Trigger Setup Edit Mode lets you alter a variety of settings for each of the trigger inputs jacks (1-10) of the Trigger Setup.

You can edit both preset (No. 1-7) and user Trigger Setups (No. 8-11).

The edited Trigger Setup can be stored in a User Trigger Setup (No. 8-11) using the Store Operation.

- * Selecting another Trigger Setup before storing your changes will result in the data reverting to its default settings.
- * Data cannot be stored to preset Trigger Setup (No. 1- 7).

■ Entering the Trigger Setup Edit Mode

Press the [TRIG] button on the front panel.

Once the Trigger Setup Edit Mode is entered, the INPUT parameter's main page (pad type), shown below, will be displayed.

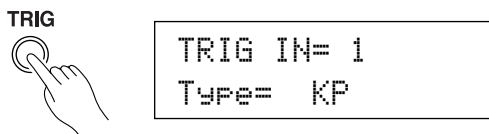

- * Double-click the [TRIG] button to enter the Trigger Setup Edit Mode. The [1-2. Gain, Minimum Velocity] display will appear.

■ What's in the Trigger Setup Edit Mode

The Trigger Setup Edit Mode is divided into two sub-groups.

1. **INPUT Parameters** → P. 36
Contains specific settings for each pad (1-10).
2. **COMMON Parameters** → P. 38
Contains common settings for all pad inputs.

Procedure

1. Before editing, it is necessary to select the trigger setup you want to edit in the drum kit play mode [Trigger Setup & Tempo].
2. Press the [TRIG] button to enter the Trigger Setup Edit mode.
3. Use the [PAGE▲], [PAGE▼] buttons to display the list you want to edit.
* If the Utility mode's [Jump to Recent Page] parameter (P. 28) is set to "on", the DTXPRESS will display the page last edited when entering the Trigger Setup Edit mode.
4. Use the [SEL◀], [SEL▶] buttons to move the cursor to the list you want to edit. The list will flash.
* If there is only one list, it is not necessary to move the cursor.

5. Use the [VALUE-], [VALUE+] buttons to set the parameter's value or ON/OFF setting.

* Once a setting is changed, "*" will appear on the display next to "TRIG". After data is saved, the mark will disappear.

```
TRIG*IN= 1
Type= KP
```

6. To store changes in the User Trigger Setup, use the following procedure.

* The changes you made will be lost if another trigger setup is selected before your changes have been stored.

- 6-1. Press the [SAVE/ENT] button. The following display will appear.

```
Store Trigger
To= 8 InitTrig
```

- 6-2. Use the [VALUE-], [VALUE+] buttons to assign the User Trigger Setup number (8-11) (located next to "To=") for storing your changes. The number and setup name will appear.

- 6-3. Press the [SAVE/ENT] button, the following display will appear asking for confirmation before the store operation is carried out.

```
Store TRG to 8
Are you sure ?
```

- 6-4. Press the [SAVE/ENT] or [VALUE+] button, the store operation will be carried out.

* Press the [VALUE-] button to cancel the store operation.

The following display will appear after the store operation is completed.

```
Complete !
```

Trigger Setup Edit Mode Function List

	Page
1. INPUT Parameters	36
1-1. Pad Type	36
1-2. Gain, Minimum Velocity	36
1-3. Velocity Curve	37
1-4. Self Rejection, Rejection	37
1-5. Specific Rejection	37
1-6. Copy Input	37
2. COMMON Parameters	38
2-1. Increment/Decrement	38
2-2. Input Exchange	38
2-3. Trigger Setup Name	38

Trigger Setup Edit Mode

1. INPUT Parameters

Contains specific settings for each of the pads (1-10). This function is divided into the following 6 pages.

- 1-1. Pad Type 36
- 1-2. Gain, Minimum Velocity 36
- 1-3. Velocity Curve 37
- 1-4. Self Rejection, Rejection 37
- 1-5. Specific Rejection 37
- 1-6. Trigger Setup Copy 37

1-1. Pad Type

Sets the type of pad or trigger sensor that is connected to the trigger input jack ①. By selecting the appropriate pad type, pad functions can be used to their full potential.

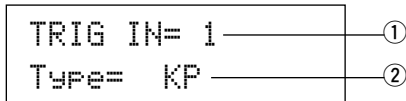

① TRIG IN (Trigger Input Number)

[Range] 1-10

Assigns the trigger input jack number for the pad you want to edit.

* According to the setting in the utility mode's [1-1. Learn Mode] (P.52) trigger input jack numbers can be assigned by hitting the pad.

② Type (Pad Type)

Sets the type of pad that is connected to the trigger input jack assigned in ① TRIG IN.

* Values set in [1-2. Gain, Minimum Velocity] (P. 36) and [1-4. Self Rejection] (P. 37) will automatically select the proper value for the pad type you set here.

* The "HH controller" can only be assigned to Input Jack 1. Connect the Hi-hat Controller HH60, HH80 or HH80A to Input Jack 1 and set to "HH controller" to use in place of a kick pedal. Use a cable with a stereo plug when connecting a Hi-hat controller.

Pad types are defined as follows.

TP snare	TP60, TP80, TP80S used as a snare pad.
TP tom	TP60, TP80, TP80S used as tom pads.
TP HH	TP60, TP80, TP80S used as a hi-hat pad.
KP	KP60, KP80, KP80A used.
PCY ride	PCY60, PCY80, PCY80S used as ride cymbal pads.
PCY crash	PCY60, PCY80, PCY80S used as crash cymbal pads.
PCY cup	PCY10, etc. used as the cymbal cup.
BP	BP80 used.
DT snare	DT10, DT20 attach to the snare drum.
DT hi tom	DT10, DT20 attach to small toms
DT lo tom	DT10, DT20 attach to large toms
DT kick 1	DT10, DT20 attach to small bass drum
DT kick 2	DT10, DT20 attach to large bass drum
misc 1	Extensive use1—high sensitivity type.
	Rim switch function is good for snare/tom use.

misc 2	Extensive use 2—high sensitivity type. Rim switch function is good for cymbal use.
misc 3	Extensive use 3—normal sensitivity type. Rim switch is good for snare/tom use.
misc 4	Extensive use 4—normal sensitivity type. Rim switch function is good for cymbal use.
misc 5	Extensive use 5—low sensitivity type. Rim switch is good for snare/tom use.
misc 6	Extensive use 6—low sensitivity type. Rim switch function is good for cymbal use.
HH controller	Connect the HH60, HH80, HH80A to Trigger Input jack 1 to use as a kick pedal. * The volume (velocity) is fixed.

* The DT10, DT20 are Yamaha Drum Trigger Sensors.

1-2. Gain, Minimum Velocity

This function sets the input sensitivity (Gain) and velocity range (Minimum Velocity) for each input jack ①.

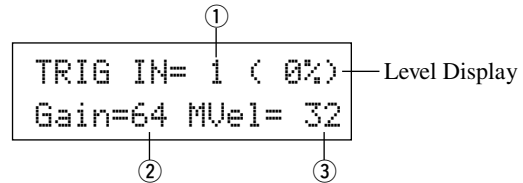

① TRIG IN (Trigger Input Number)

Assigns the trigger input jack number. (The same procedure as in [1-1. Pad Type]).

② GAIN (Input Gain)

[Range] 0-99

Adjusts the input gain level (minimum sensitivity) for the trigger input jack assigned in step ① TRIG IN.

Entering a larger value here allows smaller input levels to sound the voice.

* This value will be automatically set after the appropriate pad type is set in [1-1. Pad Type]. Some fine-tuning of the value will be necessary.

③ MVel (Minimum Velocity)

[Range] 1-127

Sets the MIDI Velocity (volume) that is transmitted when the pad is hit the weakest. Large values will produce a high volume level even if the pad is hit softly. However, this will result in a narrow volume range making it difficult to adequately produce wider dynamic levels.

If "HH controller" is set for the pad type, the value set here will be transmitted as the velocity.

The trigger input level will be displayed as a % in the upper right hand corner of the display. The maximum velocity (input level 99%) will be 127. The level is low when the pad is hit the weakest so a wider dynamic range will be possible.

* This value will be automatically set after the appropriate pad type is set in [1-1. Pad Type]. Some fine-tuning of the value will be necessary.

1-3. Velocity Curve

This function sets the MIDI Velocity Curve for the sensitivity for each input jack ①.

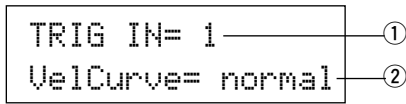

① TRIG IN (Trigger Input Number)

Assigns the trigger input jack number (the same procedure as in [1-1. Pad Type]).

② VelCurve (Velocity Curve)

Sets the Input Velocity Curve for the trigger input jack assigned in TRIG IN ①.

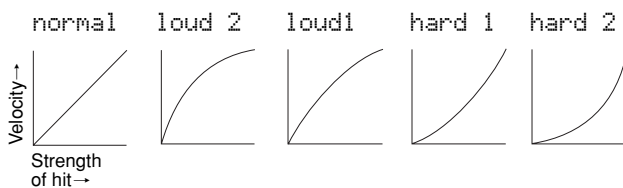

1-4. Self Rejection, Rejection

This function is used to prevent double triggers* and cross talk (mixed input signals between the jacks) for each input jack ①.

* **double trigger:** When 2 sounds are played at the same time.

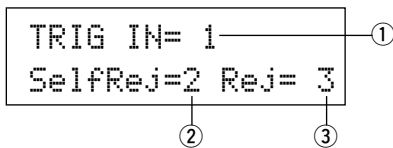

① TRIG IN (Trigger Input Number)

Assigns the trigger input jack number (the same procedure as in [1-1. Pad Type]).

② SelfRej (Self Rejection)

[Range] 0-9

Prevents double triggers from occurring in the input jack assigned in TRIG IN ①. After an event is detected, further events will be automatically muted for a certain length of time. Larger values set longer times.

③ Rej (Rejection)

[Range] 0-9

Prevents cross talk from occurring in the input jack assigned in TRIG IN ①. Events triggered by other pads (input jacks) that are of a lower input value than what is set here will not be delivered for a set length of time.

1-5. Specific Rejection

This function prevents cross talk from occurring between two specified input jacks ① and ③.

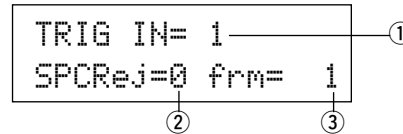

① TRIG IN (Trigger Input Number)

Assigns the trigger input jack number (the same procedure as in [1-1. Pad Type]).

② SPCRej (Specific Rejection)

[Range] 0-9

After an event occurs from the pad from the input jack assigned in ③, the pad of the input jack assigned in TRIG IN ① will not sound for a certain length of time unless the level is greater than the value assigned here.

③ frm (Assigned Destination Trigger Input Number)

[Range] 1-10, 6&7

Sets the destination trigger input jack number of the pad that will be rejected. When "6&7" is selected, both trigger inputs 6 and 7 will be assigned.

1-6. Trigger Setup Copy

This function copies all data settings in [1-1. Pad Type] to [1-5. Specific Rejection] from input jack ① to another input jack ②.

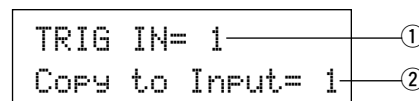

! When the Trigger Setup Copy operation is carried out, the trigger setup data will be replaced with the settings of the copy source.

① TRIG IN (Trigger Input Number)

Sets the trigger input jack number (1-10) of the pad copy source.

② Copy to Input (Trigger Input Number Copy Destination)

Sets the trigger input jack number (1-10) of the copy destination.

Procedure

1. In the display shown above, assign the copy source and copy destination, press the [SAVE/ENT] button. The following display will appear asking for confirmation before the copy operation is carried out.

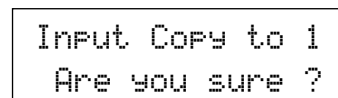

2. Press the [SAVE/ENT] or [VALUE+] button, the copy operation will be carried out.

* Press the [VALUE-] button to cancel the copy operation.

When the copy operation is complete, "Complete!" will appear.

Trigger Setup Edit Mode

2. COMMON Parameters

Contains common settings for all pad inputs (1-10).
This group is divided into the following 3 pages.

- 2-1. Increment/Decrement 38
- 2-2. Input Exchange 38
- 2-3. Trigger Setup Name 38

2-1. Increment/Decrement

This sets the pad function that allows the currently selected drum kit number to be increased or decreased by 1 by hitting the specified pad.

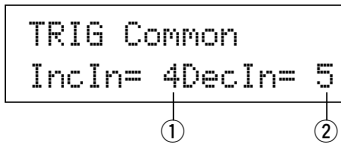

① Incin (Pad for Increment)

[Range] —, 1-10

Assigns the trigger input jack number that is set for the increment (+1) function. “--” will appear when this function is not assigned to the pad.

② Decin (Pad for Decrement)

[Range] —, 1-10

Assigns the trigger input jack number that is set for the decrement (-1) function. “--” will appear when this function is not assigned to the pad.

- * Even when the drum kit is changed, the pads connected to the assigned trigger input jacks will retain their increment/decrement functions. To assign this function to each drum kit, refer to the Drum Kit Voice Edit mode's [2-6. Function] (P. 44)

2-2. Input Exchange

Switches the trigger signal from the pads between trigger input jacks 1 and 9/10.

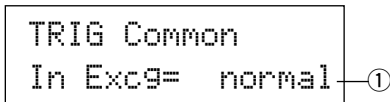

① In Excg (Input Exchange)

normal: Normal operation.

In10, 1/9: The signals from Input Jacks 1 and 9/10 are switched.

When the input jack 1 pad is hit.

- This event will be recognized as a signal from the input jack 10 pad (as if a trigger were received from input jack 10) and operate accordingly.

When the input jack 1 rim is hit.

- Normal operation. This event will be recognized as a signal from the input jack 1 rim.

When the input jack 9 pad is hit.

- This event will be recognized as a signal from the input jack 1 pad (as if a trigger were received from input jack 1) and operate accordingly.

When the input jack 10 pad is hit.

- This event will be recognized as a signal from the input jack 9 pad (as if a trigger were received from input jack 9) and operate accordingly.

2-3. Trigger Setup Name

Changes the name of the currently selected (currently being edited) Trigger Setup.

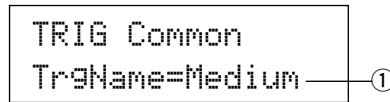

① TrgName (Trigger Setup Name)

Procedure

1. In the display shown above, use the [SEL◀]/[SEL▶] buttons to move the cursor to the character you want to change.
2. Use the [VALUE-]/[VALUE+] buttons to select the alphabet, number or symbol.
3. Repeat steps 1 and 2 above to create the Trigger Setup name using a maximum of 8 characters.

- The available characters to choose from are (in order):

space
! " # \$ % & ' () * + , - . / 0 1 2 3 4 5 6 7 8 9 : ; < = > ? @
A B C D E F G H I J K L M N O P Q R S T U V W X Y Z [\] ^ _ `
a b c d e f g h i j k l m n o p q r s t u v w x y z { | } ~

Drum Kit Voice Edit Mode

This mode lets you set which voice and how it will be triggered for each pad (trigger input source) in the currently selected drum kit.

■ What you can do with the Drum Kit Voice Edit Mode

This mode contains various settings related to the currently selected drum kit (data in the edit buffer for the drum kit).

You can edit both preset (No. 1-48) and user drum kits (No. 49-80).

The edited drum kit can be stored in a User Drum Kit (No. 49-80) using the Store Operation.

- * Selecting another drum kit before storing your changes will result in the data reverting to its default settings.
- * Data cannot be stored to preset drum kits (No. 1- 48).

■ Entering the Drum Kit Voice Edit Mode

Press the [VOICE] button on the front panel.

Once the Drum Kit Voice Edit Mode is entered, the Voice Parameter main page (Voice) shown below will be displayed.

VOICE



```
KIT IN=pad 1 V=1
=K/017 BDafty1
```

- * Double-click the [VOICE] button to enter the Drum Kit Voice Edit Mode. The [1-2. Volume, Pan] display will appear.

■ What's in the Drum Kit Voice Edit Mode

The Drum Kit Voice edit Mode is divided into the following five sub-groups.

- 1. Voice Parameters** (→ P. 40)
Sets the voice for each input source of the pad.
- 2. Input Common Parameters** (→ P. 43)
Common settings related to the 2 layers for each pad input source's voice parameter.
- 3. Reverb Parameters** (→ P. 45)
Sets the internal reverb effect.
- 4. Setup** (→ P. 46)
When the drum kit is selected, this function copies the drum kit voice settings and MIDI transmit settings.
- 5. Drum Kit Common Parameters** (→ P. 47)
Common settings for the entire drum kit.

Procedure

- 1.** Before editing, it is necessary to select the drum kit you want to edit in the Drum Kit Play Mode of the [Drum Kit & Song] display.
- 2.** Press the [VOICE] button to enter the Drum Kit Voice Edit Mode.

- 3.** Use the [PAGE▲], [PAGE▼] buttons to display the page you want to edit.

* If the Utility Mode's [1- 4. Jump to Recent Page] (P.52) parameter is set to "on", the DTXPRESS will display the page last edited when entering the Drum Kit Voice Edit Mode.

- 4.** Use the [SEL◀]/[SEL▶] buttons to move the cursor to the parameter you want to edit. The parameter will flash.

* If there is only one parameter, it is not necessary to move the cursor.

- 5.** Use the [VALUE-]/[VALUE+] buttons to set the parameter's value or ON/OFF setting. Pressing the [VOICE] button lets you listen to the Drum Kit Voice while editing.

* Once a setting is changed, "*" will appear on the display next to "KIT". After data is stored, the mark will disappear.

```
KIT*IN=pad 1 V=1
=K/019 MapleA20
```

- 6.** To store your changes in a User Drum Kit, use the Store Operation described below.

* The changes you made will be lost if another drum kit is selected before your changes have been stored.

- 6-1.** Press the [SAVE/ENT] button. The following display will appear.

```
Store Drunkit
To= 49 Init Kit
```

- 6-2.** Use the [VALUE-]/[VALUE+] buttons to assign the Drum Kit number (49-80) (located next to "To="). The number and drum kit name will appear.

- 6-3.** Press the [SAVE/ENT] button, the following display will appear asking for confirmation before the store operation is carried out.

```
Store KIT to= 49
Are you sure ?
```

- 6-4.** Press the [SAVE/ENT] or [VALUE+] button, the store operation will be carried out.

* Press the [VALUE-] button to cancel the store operation.

The following display will appear after the store operation is complete.

```
Complete !
```

Drum Kit Voice Edit Mode Function List

	Page
1. Voice Parameters	40
1-1. Voice	41
1-2. Volume, Pan	41
1-3. Tuning	41
1-4. Layer Balance	42
1-5. Decay, Cutoff Frequency	42
1-6. Note Number	42
1-7. Channel, Gate Time	42
2. Input Common Parameters	43
2-1. Cross Fade	43
2-2. Reverb Send	43
2-3. Alternate Group, Key Assign Mode	43
2-4. Hold Mode	44
2-5. Key Off Enable	44
2-6. Function	44
2-7. Pad Song	44
2-8. Rim to Pad	45
3. Reverb Parameters	45
3-1. Reverb Type, Time	45
3-2. Reverb Master Return	45
4. Setup	46
4-1. Program Change, Bank Select	46
4-2. Volume, Pan	46
4-3. Drum Kit Voice Copy	46
5. Drum Kit Common Parameters	47
5-1. Volume	47
5-2. Drum Reverb Send	47
5-3. Hi-Hat Sensitivity	47
5-4. Song Select	47
5-5. Drum Kit Name	47

1. Voice Parameters

Sets the voice for each input source of the pad.

The Input Source is trigger data that is transmitted by the pads or trigger sensors connected to input jacks 1-10 of the DTXPRESS. When monaural pads TP60/80, KP60/80, PCY60/80, DT10/20, etc. are used, one Input Source will be assigned to one input jack. When stereo pads TP80S, PCY80S, etc. are used, two Input Sources (pad input and rim switch input or 2 kinds of pad input, etc.) will be assigned to one input jack.

The Voice Parameter is divided into the following 7 pages.

1-1. Voice	41
1-2. Volume Pan	41
1-3. Tuning	41
1-4. Layer Balance	42
1-5. Decay, Cutoff Frequency	42
1-6. Note Number	42
1-7. Channel, Gate Time	42

Select the Input Source for Editing

In Voice Parameter edit display, first it is necessary to select the input source ① for editing.

Also, 2 voices/key on events/occurrences (2 voices delivered with one strike of the pad) can be assigned to one trigger input. This use is called "2 layer". When a 2 layer is used, assign the layer number ② that is used.

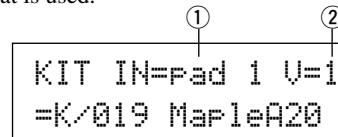

① IN (Input Source)

Each Input Source is defined as follows.

- Pad 1** Pad input for Trigger Input Jack 1.
- rim 1** Rim switch input for Trigger Input Jack 1.
- Pad 2** Pad input for Trigger Input Jack 2.
- rim 2** Rim switch input for Trigger Input Jack 2.
- :
- rim 6** Rim switch input for Trigger Input Jack 6.
- Pad 7** Pad input for Trigger Input Jack 7.
- rim 7** Rim switch input for Trigger Input Jack 7.
- open** Pad input (when the hi-hat controller is not fully closed) for Trigger Input Jack 8.
- rimOpen** Rim switch input (when the hi-hat controller is not fully closed) for Trigger Input Jack 8.
- close** Pad input (when the hi-hat controller is fully closed) for Trigger Input Jack 8.
- rimCls** Rim switch input (when the hi-hat controller is fully closed) for Trigger Input Jack 8.
- footCl** Event when the hi-hat controller is depressed for Trigger Input Jack 8.
- splash** Splash event for the hi-hat controller for Trigger Input Jack 8.

Pad 9 Pad input for Trigger Input Jack 9.

Pad 10 Pad input for Trigger Input Jack 10.

- * According to the setting in the Utility Mode's [1-1. Learn Mode] (P. 52), the input source can be assigned by hitting the pad.
- * Monaural pads do not have a rim switch function.

② Layer Number

[Range] 1, 2, -

When 2 layers are used, use this setting to select which layer ("1" or "2") will be set.

When only 1 voice is set, "--" will appear and you will not be able to switch.

- * Use the [1-1. Voice] display to set whether 2 layer or 1 voice will be used.

If the same MIDI note number is set to more than one pad within the same drum kit, the lowest numbered Trigger Input Jack will take priority. Regardless of which pad is struck, the same voice (setting) will be delivered.

1-1. Voice

This function assigns the voice (drum voice) ③ for each input source ①. Two voices ② can be assigned for simultaneous delivery to 1 input source (when the pad is hit once).

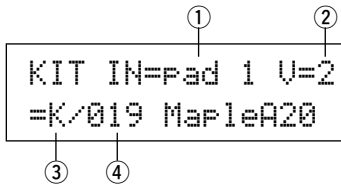

① IN (Input Source)

② Layer Number

Assigns the input source and layer for the setting. (Refer to P. 40)

Sets whether 2 layer or 1 voice will be used in this display. Only "1" or "2" can be selected in the Layer Number.

③ Voice Category

Selects the drum voice category that will be delivered by Layer 2 of Input Source ①.

Each of the following characters indicates a drum voice category.

- K: Acoustic Kick
- k: Electric Kick
- S: Acoustic Snare
- s: Electric Snare
- T: Acoustic Tom
- t: Electric Tom
- C: Cymbal
- H: Hi-hat
- P: Percussion
- E: Effect 1
- e: Effect 2
- L: Drum Loop
- M: misc. voices

④ Voice Number Voice Name

Selects the assigned voice. The Voice Number (1-127) and Voice Name will be displayed. When 2 Layer is selected, "*" will be displayed next to the Voice Name.

When "0" is selected, "NoAssignment" will be displayed in place of the Voice Name and no sound will be delivered.

- * Refer to the [Drum Voice List] (P. 68).

1-2. Volume, Pan

This function sets the Volume ③ and Pan ④ (the position in the stereo field) for each drum voice that is delivered by each layer ② of the input source ①.

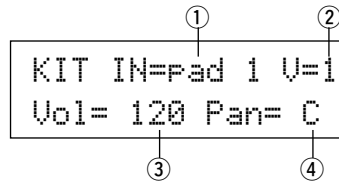

① IN (Input Source)

② Layer Number

Assigns the input source and layer for setting. (Refer to P. 40)

③ Vol (Volume)

[Range] 0-127

④ Pan

[Range] L64 to C to R64

1-3. Tuning

This function sets the pitch for each drum voice that is delivered by each layer ② of the input source ①.

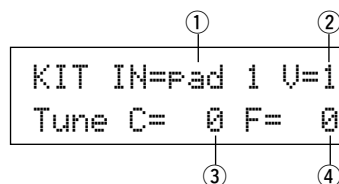

① IN (Input Source)

② Layer Number

Assigns the input source and layer for setting. (Refer to P. 40)

③ Tune C (Tune Coarse)

[Range] -24 to 0 to +24

Tuning can be set increments of a half step.

④ Tune F (Tune Fine)

[Range] -64 to 0 to +63

Tuning can be set increments of approximately 1.17 cents.

Drum Kit Voice Edit Mode

1-4. Layer Balance

When a drum voice is made up of 2 layers (a single voice consisting of 2 voice waves), this function sets the volume balance between the 2 layers that are delivered by each layer ② of the input source ①.

* When only a 1 layer voice is set, this setting will be ignored.

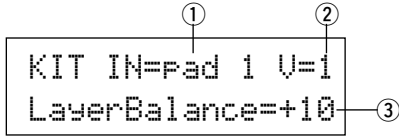

① **IN (Input Source)**

② **Layer Number**

Assigns the input source and layer for the setting. (Refer to P. 40)

③ **LayerBalance (Layer Balance)**

[Range] -64 to 0 to +63, ----

Sets the volume balance between 2 layers.

* When the drum voice has only 1 layer "----" will appear in the display and settings cannot be carried out.

1-5. Decay, Cutoff Frequency

This function sets the drum voice decay, the filter's cutoff frequency and adjusts the tone of each voice that is delivered by each layer ② of the input source ①.

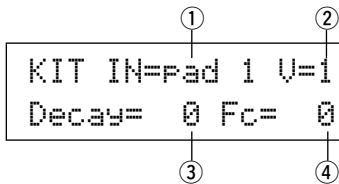

① **IN (Input Source)**

② **Layer Number**

Assigns the input source and layer for the setting. (Refer to P. 40)

③ **Decay**

[Range] -64 to 0 to +63

Positive values will produce a clearer sound.

④ **Fc (Cutoff Frequency)**

[Range] -64 to 0 to +63

A positive value will produce a brighter sound, negative values will produce a rounder sound.

1-6. Note Number

This function sets the MIDI note number for each layer ② that is transmitted when a signal is received from the input source ①.

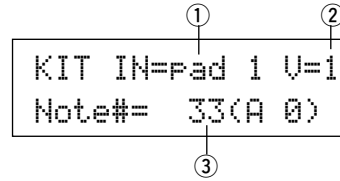

① **IN (Input Source)**

② **Layer Number**

Assigns the input source and layer for the setting. (Refer to P. 40)

③ **Note# (MIDI Note Number)**

[Range] 0-127 (C-2 to G8)

Sets the MIDI note number. The note number and voice name will be displayed.

* When the selected MIDI note number has already been assigned to another input source, "*" will be displayed next to "Note#=".

1-7. Channel, Gate Time

This function sets the MIDI transmit channel and gate time (the length of time from key on to key off) for the MIDI note on data of each layer ② that is transmitted when a signal is received from the input source ①.

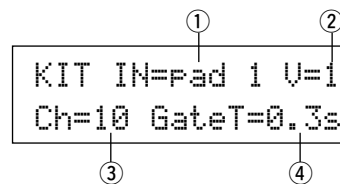

① **IN (Input Source)**

② **Layer Number**

Assigns the input source and layer for the setting. (Refer to P. 40)

③ **Ch (MIDI Channel)**

[Range] 1-16

④ **GateT (Gate Time)**

[Range] 0.0s - 9.9s

2. Input Common Parameters

This sub-mode sets the common settings between 2 layers for voice parameters of each pad's input source.

The Input Common Parameters sub-group is divided into the following 8 pages.

2-1. Cross Fade	43
2-2. Reverb Send	43
2-3. Alternate Group, Key Assign Mode	43
2-4. Hold Mode	44
2-5. Key Off Enable	44
2-6. Function	44
2-7. Pad Song	44
2-8. Rim to Pad	45

Select the Input Source for editing

In the Input Common Parameters edit display, first it is necessary to select the input source ① for editing. (Refer to page 40 on how to select the input source.)

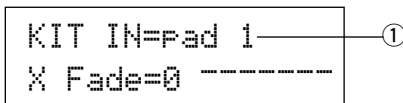

However, the same as in Voice Parameters, "If the same MIDI note number is set to more than one pad within the same drum kit, the lowest numbered trigger input jack will take priority. Regardless of which pad is struck, the same voice (setting) will be delivered." So, when the setting is invalid in edit displays [2-1. Cross Fade] – [2-5. Key Off Enable], the following display will appear and edits cannot be carried out.

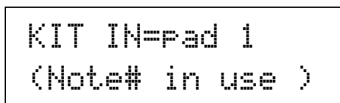

2-1. Cross Fade

This function sets the velocity (volume) cross fade between the 2 layer voices delivered by the input source ①.

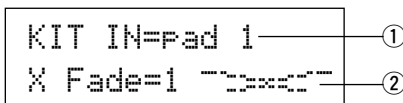

① IN (Input Source)

Assigns the Input Source for setting. (Refer to the display shown above.)

② j (Cross Fade Type)

[Range] 0-9

Selects the cross fade type ("1" to "9"). The conversion graph will appear to the right of the type number.

If this parameter is set to "0", the cross fade function will not be valid.

2-2. Reverb Send

This function sets the reverb send level ② for the voice (layer 1, 2) delivered by the input source ①.

* The actual reverb send level will be determined by multiplying the level set here with the level set in [5-2. Drum Reverb Send] (P. 47).

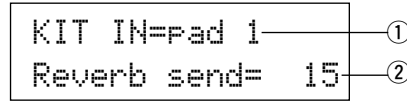

① IN (Input Source)

Assigns the input source for the setting. (Refer to P. 40)

② Reverb send (Reverb Send Level)

[Range] 0-127

2-3. Alternate Group, Key Assign Mode

This function sets the Alternate Group and Key Assign Mode for the voice (layer 1, 2) delivered by the input source ①.

Alternate Group: This is a group of voices assigned to the same group number that should not be delivered at the same time. For example, by assigning an open hi-hat with a closed hi-hat to the same group number, the open hi-hat sound will be canceled once the closed hi-hat sound is delivered.

Key Assign Mode: This defines the sound output rules when multiple voices that are assigned to the same MIDI note number are simultaneously delivered.

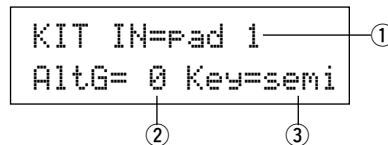

① IN (Input Source)

Assigns the input source for the setting. (Refer to P. 40)

② AltG (Alternate Group)

Voices that are assigned to the same MIDI note number that you do not want to be delivered simultaneously. If this parameter is set to "0" there will be no truncation.

* Some alternate group voices like Hi-Hat, etc., are preset in the voices.

③ Key (Key Assign Mode)

This defines the sound output rules when multiple voices that are assigned to the same MIDI note number are simultaneously delivered.

poly: There are no limits to the number of voices delivered at once.

semi: Up to 2 voices for this note number can be produced at one time. When a 3rd voice is triggered, one of the first 2 voices will be truncated.

mono: One voice can be delivered at one time, the previous voice will be truncated.

high: One voice can be delivered at one time, the previous voice will be truncated. However, even if the maximum number of 32 notes is exceeded, the note number selected here will not be truncated.

Drum Kit Voice Edit Mode

2-4. Hold Mode

Sets the Hold Mode for the voice (layer 1, 2) delivered by input source ①.

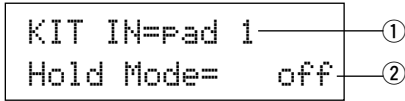

① IN (Input Source)

Assigns the input source for the setting. (Refer to P. 40)

② Hold Mode

on: Each time the pad is hit either a MIDI key on or MIDI key off event will be transmitted in succession.

off: Normal operation. When a pad is hit, only a MIDI key on event will be transmitted (after the decay time is up, key off will be transmitted automatically).

- * If this function is set to "on", it is recommended that you use the "key=high" setting in [2-3. Alternate Group, Key Assign Mode] (P. 43).

2-5. Key Off Enable

This function decides whether or not to recognize MIDI key off messages for the voice (layer1, 2) delivered by the input source ①.

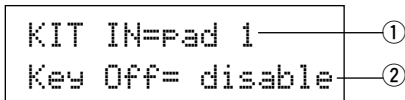

① IN (Input Source)

Assigns the input source for the setting. (Refer to P. 40)

② Key Off

enable: Recognizes key off.

disable: Does not recognize key off.

- * When this function is set to "disable", some voices may sound continuously. Press the [SHIFT] plus [VOICE] buttons to stop voices sounding.

2-6. Function

Along with the voice, this function can be used to control other functions ② according to the trigger from the input source ①.

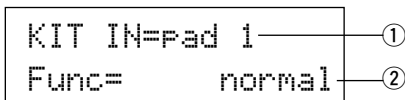

① IN (Input Source)

Assigns the input source for the setting. (Refer to P. 40)

② Func (Function)

Selects the function that is controlled by the trigger input.

normal: Normal operation.

pad song: Controls playback of the pad song*.

click on/off: Switches the click sound on/off.

inc drumkit: Increases the value of the drum kit number by 1 (increment).

dec drumkit: Decreases the value of the drum kit number by 1 (decrement).

trig bypass: Switches the trigger bypass function on/off (P. 28).

start/stop: Controls playback of the main song*.

main song: The main song is the selected in the Drum Kit Play mode, and is controlled from the panel (of MIDI/TO HOST jack).

pad song: According to this setting, playback of the pad song will be controlled by the trigger input. The pad song can be played independently of the main song. Also, up to 3 pad songs can be played along with main song simultaneously.

* Refer to the [2-7. Pad Song] for more information on setting the Pad Song.

* When 3 pad songs have already been selected in another input source, the "Pad song" will not be displayed ("-----" is displayed).

2-7. Pad Song

This function contains settings for the pad song.

These settings are affective when a trigger from the input source ①, which is set in [2-6. Function], controls playback of the pad song.

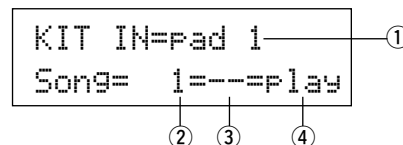

① IN (Input Source)

Assigns the input source for the settings (Refer to P. 40).

② Song Number

Assigns the song number (1-127) that is assigned to the pad song.

③ Repeat Playback

RF: Repeats playback of the song (when the song reaches the end it will start again from the beginning, continuously).

--: Normal playback.

④ Playback Mode

Play: When a pad is hit, playback of the assigned pad song will start/stop.

chse: When the pad is hit, one measure of the assigned pad song will start playback then pause.

ctof: When the pad is hit, playback of the assigned pad song will start/stop. However, if the pad song is set to "ctof" the pad song will stop when another pad song with the "ctof" setting is started. This function allows only one "ctof" pad song to be played at a time.

- * Only data for MIDI channels 7, 8, 9, 10 is played back with the pad song.
- * If the Pad Song's tempo or voices are irregular, re-select the Drum Kit.
- * The following restrictions prevent overlapping of the main song and MIDI channels.
 - The first pad song in the drum kit will be transmitted on the MIDI channel number that is determined by subtracting "4" from the original MIDI channel number.
 - The second pad song in the drum kit will be transmitted on the MIDI channel number that is determined by adding "4" from the original MIDI channel number.
 - The third pad song in the drum kit will be transmitted after the MIDI channel is converted as follows.
 The original MIDI channel → MIDI transmit channel
 7 → 15, 8 → 16, 9 → 1, 10 → 2.

2-8. Rim To Pad

This function is only in affect when the input source ① is from a rim switch.

When the rim is hit, pad events triggered from the same pad (trigger input jack) can be simultaneously transmitted with rim switch events.

According to this setting, the pad can be triggered at the same time as the snare's rim shot.

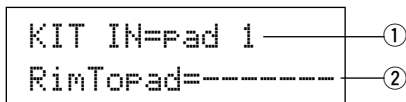

① IN (Input Source)

Assigns the input source for the setting (Refer to P. 40).

- * Selects the rim switch source.

② RimToPad (Rim to Pad)

Sets the event that is transmitted when the rim is hit.

disable: Only transmits rim switch event.

enable: Transmits rim switch event and pad event.

- * When an input other than the rim switch is selected for the input source, "-----" will be displayed and settings can not be carried out.

3. Reverb Parameters

This function sets the internal reverb effect of the DTXPRESS. The reverb parameters are divided into the following 2 pages.

- 3-1. Reverb Type, Time 45
- 3-2. Reverb Master Return 45

3-1. Reverb Type, Time

Sets the type of reverb effect and reverb time for each drum kit.

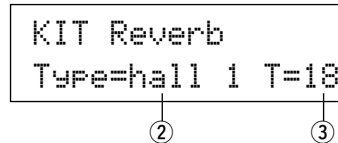

① Type (Reverb Type)

Sets the reverb type.

none: No reverb (the same as thru).

hall 1: Simulates reverb in a small hall.

hall 2: Simulates reverb in a large hall.

room 1: Simulates reverb in a small room.

room 2: Simulates reverb in a large room.

room 3: Simulates reverb in a room with a high ceiling.

stage 1: Simulates playing on a large stage.

stage 2: Simulates playing on a small stage.

Plate: Simulates steel plate reverb.

white: A special short reverb effect.

tunnel: Simulates the reverb of a tunnel.

bsemnt: Simulates the reverb of a basement.

② T (Reverb Time)

[Range] 0-69

Sets the reverb time.

This function can be used to change the characteristic of the reverb's sound.

3-2. Reverb Master Return

This function sets the signal return level from the reverb effect for every drum kit. By setting the level, you can adjust the reverb effect of the entire DTXPRESS system.

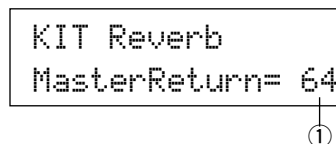

① MasterReturn (Master Return)

[Range] 0-127

Drum Kit Voice Edit Mode

4. Setup

When a drum kit is selected, this function copies MIDI transmit data settings and drum kit voice settings.

The Setup sub-group is divided into the following 3 pages.

- 4-1. Program Change, Bank Select 46
- 4-2. Volume, Pan 46
- 4-3. Drum Kit Voice Copy 46

4-1. Program Change, Bank Select

When a drum kit is selected, this function sets the MIDI Program Channel Number ③, the Bank Select MSB ④ and LSB ⑤ that will be transmitted.

This can be set ② for each MIDI channel ①.

By switching the drum kit, you can change the voice in an external MIDI device.

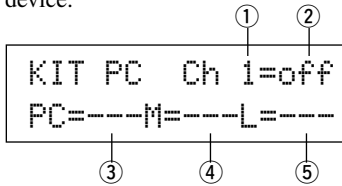

- ① **MIDI Channel**
[Range] Ch1–Ch16
- ② **Program Change Transmit On/Off**
on: Transmits.
off: Does not transmit.
- ③ **PC (Program Change Number)**
[Range] 1-128
- ④ **M (Bank Select MSB)**
- ⑤ **L (Bank Select LSB)**
[Range] 0-127

Sets the bank for when the drum kit is switched. The bank will be assigned with the 2 values set in Bank Select MSB and LSB.

* Refer to the Voice List and MIDI Data Format, etc. of the external MIDI device you are using for more information on Bank Select MSB, LSB.

4-2. Volume, Pan

When a drum kit is selected, this function sets the MIDI Control Change Volume ③ and the Pan ④ that will be transmitted.

This can be set ② for each MIDI channel ①.

By switching the drum kit, you can change the voice volume and pan in an external MIDI device.

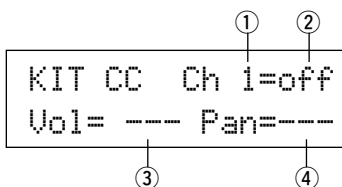

- ① **MIDI Channel**
[Range] Ch1–Ch16
- ② **Control Change Transmit On/Off**
on: Transmits
off: Does not transmit
- ③ **Vol (Volume)**
[Range] 1-128
Sets the Volume Control Change data value that will be transmitted.
- ④ **Pan**
[Range] 0-127
Sets the Pan Control Change data value that will be transmitted.

4-3. Drum Kit Voice Copy

This function copies all data settings in [1-1. Voice] – [2-7. Pad Song] from the Input Source ① to another Input Source ②.

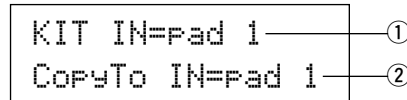

! When the Drum Kit Voice Copy operation is carried out, the Drum Kit Voice data in the destination Input Jack will be replaced with the data of the copy source.

- ① **IN (Input Source Copy Source)**
Sets the input source of the copy source. (Refer to P. 40)
- ② **CopyTo IN (Input Source Copy Destination)**
Sets the input source of the copy destination. (Refer to P. 40)

Procedure

1. In the display shown above, assign the input source for the copy source and copy destination, press the [SAVE/ENT] button.

The following display will appear asking for confirmation before the copy operation is carried out.

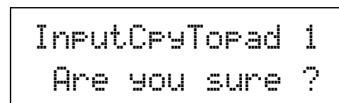

2. Press the [SAVE/ENT] or [VALUE+] button, the copy operation will be carried out.

* Press the [VALUE-] button to cancel the copy operation.

When the copy operation is complete, "Complete!" will appear.

5. Drum Kit Common Parameters

This function sets the common settings for the entire drum kit. The Drum Kit Common Parameters are divided into the following 5 pages.

5-1. Volume	47
5-2. Drum Reverb Send	47
5-3. Hi-Hat Sensitivity	47
5-4. Song Select	47
5-5. Drum Kit Name	47

5-1. Volume

Sets the overall volume for the drum voice.

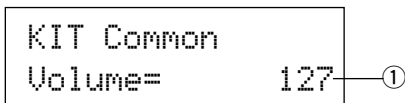

- ① **Volume**
[Range] 0-127

5-2. Drum Reverb Send

Sets the overall reverb send level of the drum voice.

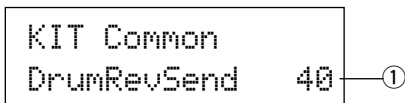

- ① **DrumRevSend (Drum Reverb Send Level)**
[Range] 0-127

The actual reverb send level will be determined by multiplying the reverb send level set in [2-2. Reverb Send] (P. 43) with the value set here.

5-3. Hi-Hat Sensitivity

Sets the foot controller sensitivity connected to HI-HAT CONTROL jack on the rear panel.

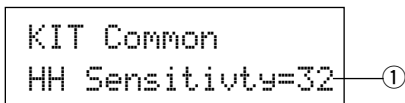

- ① **HH Sensitivity**
[Range] 0-63
Larger values provide higher sensitivity.

5-4. Song Select

This parameter allows you to switch the main song ① at the same time the drum kit is switched.

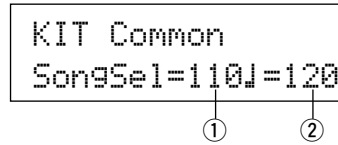

- ① **Song Select (Song Number)**

[Range] —, 1-127

Assign the song number to select the song for playback. The song will not be switched if the setting is set to “---”.

- ② **♪ (Tempo)**

[Range] —, 30-300

Assign the tempo that will be used. If “---” is set, the tempo will not change.

5-5. Drum Kit Name

Changes the drum kit name that is currently selected for editing.

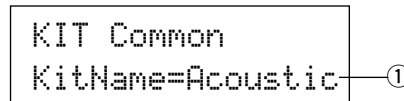

- ① **KitName (Drum Kit Name)**

Procedure

1. In the display shown above, use the [SEL ◀]/[SEL ▶] buttons to move the cursor to the character you want to change.
2. Use the [VALUE-]/[VALUE+] buttons to select the alphabet, number or symbol.
3. Repeat steps 1 and 2 above to create the Drum Kit Name using a maximum of 8 characters.

- The available characters to choose from are (in order):

```
space
!"#$%&'()*+,-./0123456789:;<=>?@
ABCDEFGHIJKLMNOPQRSTUVWXYZ[^\`~
abcdefghijklmnopqrstuvwxyz{|}~
```

Song Job Mode

This function edits the **User Song (No. 97-128)** that is currently selected.

■ Entering the Song Job Mode

Press the [SONG] button on the front panel.

Once the Song Job Mode is entered, the main page (Tempo, Repeat Playback) shown below will be displayed.

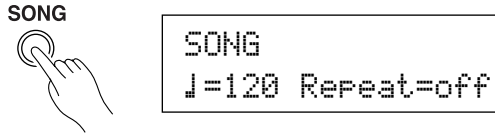

* Double-click the [SONG] button to enter the Song Job Mode and the [8. Clear Song] display will appear.

■ What's in the Song Job Mode

The Song Job Mode is divided into the following 9 pages.

1. Tempo, Repeat Playback	48
2. Program Change, Bank Select	48
3. Volume, Pan	49
4. Song Copy	49
5. Quantize	49
6. Clear Track	50
7. Merge Track	50
8. Clear Song	50
9. Song Name	50

Procedure

- Before editing, it is necessary to select the User Song (No. 97-128) you want to edit in the Drum Kit Play Mode's [Drum Kit & Song] display or [Song & Mute] display.
- Press the [SONG] button to enter the Song Job Mode.
 - * If the [SONG] button is pressed when a preset song is already selected, "ERROR Preset Data" will appear and the Song Job Mode cannot be entered.
- Use the [PAGE▲]/[PAGE▼] buttons to display the page you want to edit.
 - * If the Utility Mode's [1-4. Jump To Recent Page] (P. 52) parameter is set to "on", The DTXPRESS will display the page last edited when entering the Song Job Mode.
- Use the [SEL◀]/[SEL▶] buttons to move the cursor to the parameter you want to edit. The parameter will flash.
 - * If there is only one parameter, it is not necessary to move the cursor.
- Use the [VALUE-]/[VALUE+] buttons to set the parameter's value or ON/OFF setting.

Any settings made in the Song Job Mode will directly change the settings in the memory of the DTXPRESS. It is not necessary to use the Store Operation.

1. Tempo, Repeat Playback

This function changes the tempo (rewrites the tempo information in the song's header) and sets the repeat playback of the user song.

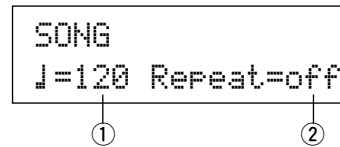

① J (Tempo)

[Range] 30-300

② Repeat (Repeat Playback)

[Range] off, on

If this is set to "on", the user song will repeat playback.

If this is set to "off", the user song will play normally.

2. Program Change, Bank Select

This function changes the voices that will be used for each MIDI channel in the user song (rewrites the voice information in the song's header). This program change will be transmitted when a song is selected and when song playback is stopped.

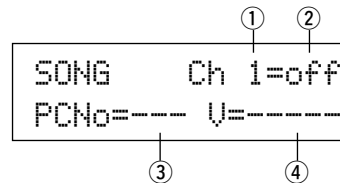

① MIDI Channel

[Range] Ch1-Ch16

② Program Change Transmit On/Off

on: Transmits.

off: Does not transmit.

③ PCNo (Program Change Number)

[Range] 1-128

④ V (Bank Select)

[Range] melody, drumV

Sets the bank that will be switched.

melody: Transmits the melody voice program change (MSB=0).

drumV: Transmits the drum voice program change (MSB=127).

3. Volume, Pan

This function changes the volume and pan settings for each MIDI channel in the user song (rewrites the Voice information in the song's header). This control change will be transmitted when a song is selected and when song playback is stopped.

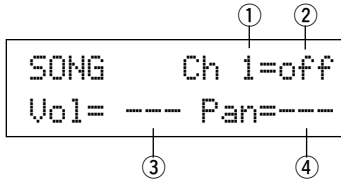

① **MIDI Channel**

[Range] Ch1-Ch16

② **Control Change transmit On/Off**

on: Transmits.

off: Does not transmit.

③ **Vol (Volume)**

[Range] 0-127

④ **Pan**

[Range] 0-127

4. Song Copy

This function copies the assigned song ① to the user song that is currently selected.

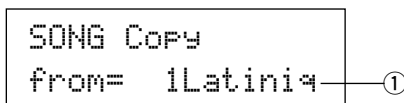

When the Song Copy operation is carried out, all data in the User Song that is currently selected will be replaced with data of the copy source.

① **from (Copy Source)**

[Range] 1-127

Sets the song that is the copy source. The song number and name will be displayed. A preset song or a user song can be assigned.

Procedure

- Assign the Copy Source Song on the display shown above, press the [SAVE/ENT] button. The following display will appear asking for confirmation before the copy operation is carried out.

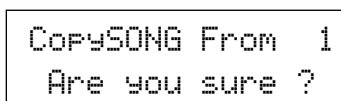

- Press the [SAVE/ENT] or [VALUE+] button, the copy operation will be carried out.

- * Press the [VALUE-] button to cancel the copy operation.
- * During song playback, the copy operation cannot be carried out. "ERROR SEQ is Running" will appear. Stop the song and try the copy operation again.
- * If memory is insufficient when in the copy operation, "ERROR Memory Full" will appear. Clear any unnecessary user songs and try the copy operation again.

When the copy operation is complete, "Complete!" will appear.

5. Quantize

This function quantizes each track ① of the user song to the accuracy ② defined here.

quantize: When the timing of the sequence data that was recorded is inaccurate, this function is used to correct the timing. The accuracy for correcting can be assigned using note lengths.

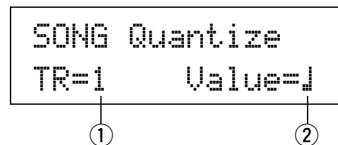

When the Quantize operation is carried out, all data in the assigned track of the currently selected user song will be replaced.

① **TR (Specified Track)**

Assigns the track ("1" or "2") to be quantized.

② **Value (Quantize Accuracy)**

[Range] ↓ quarter note, ↓ quarter note (triplet),
 ↓ eighth note, ↓ eighth note (triplet),
 ↓ sixteenth note, ↓ sixteenth note (triplet)

Procedure

- Set the track and the quantize accuracy on the display shown above, press the [SAVE/ENT] button. The following display will appear asking for confirmation before the quantize operation is carried out.

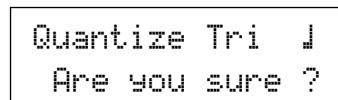

- Press the [SAVE/ENT] or [VALUE+] button, the quantize operation will be carried out.

- * Press the [VALUE-] button to cancel the quantize operation.
- * During song playback, the quantize operation cannot be carried out. "ERROR SEQ is Running" will appear. Stop the song and try the quantize operation again.
- * If memory is insufficient when in the quantize operation, "ERROR Memory Full" will appear. Clear any unnecessary user songs and try the quantize operation again.

When the quantize operation is complete, "Complete!" will appear.

Song Job Mode

6. Clear Track

This function clears all data in the assigned track ① in the user song.

```
SONG Clear Track
Track=1
```

① TR (Specified Track)

Assigns the track ("1" or "2") to be cleared.

Procedure

1. Assign the track you want to clear on the display shown above, press the [SAVE/ENT] button. The following display will appear asking for confirmation before the clear track operation is carried out.

```
Clear Track 1
Are you sure ?
```

2. Press the [SAVE/ENT] or [VALUE+] button, the clear track operation will be carried out.
 - * Press the [VALUE-] button to cancel the clear track operation.
 - * During song playback, the clear track operation cannot be carried out. "ERROR SEQ is Running" will appear. Stop the song and try the clear track operation again.

When the Clear Track operation is complete, "Complete!" will appear.

7. Merge Track

This function merges (mixes) the sequence data in tracks 1 and 2 of the user song to track 1.

```
SONG Merge Track
Are you sure ?
```

Procedure

1. Press the [SAVE/ENT] button on the display shown above, the merge operation will be carried out. When the Merge Track operation is complete, "Complete!" will appear.
 - * If memory is insufficient when in the merge operation, "ERROR Memory Full" will appear. Clear any unnecessary user songs and try the merge operation again.
 - * During song playback, the merge operation cannot be carried out. "ERROR SEQ is Running" will appear. Stop the song and try the merge operation again.

8. Clear Song

This function clears the sequence data in tracks 1 and 2 of the user song.

```
SONG Clear Song
Are you sure ?
```

Procedure

1. Press the [SAVE/ENT] button on the display shown above, the clear song operation will be carried out. When the Clear Song operation is complete, "Complete!" will appear.
 - * During song playback, the clear song operation cannot be carried out. "ERROR SEQ is Running" will appear. Stop the song and try the clear song operation again.

9. Song Name

This function changes the user song name that is currently selected (for editing).

```
SONG
SngName=no name
```

① SngName (Song Name)

Procedure

1. Use the [SEL ◀]/[SEL ▶] buttons to move the cursor to the character you want to change on the display shown above.
2. Use the [VALUE-]/[VALUE+] buttons to select the alphabet, number or symbol.
3. Repeat steps 1 and 2 above to create the User Song Name using a maximum of 8 characters.

- The available characters to choose from are (in order):
space

```
!"#$%&'()*+,-./0123456789:;<=>?@
ABCDEFGHIJKLMNOPQRSTUVWXYZ[^\`_
abcdefghijklmnopqrstuvwxyz{|}~
```

Utility Mode

This mode sets general parameters for the DTXPRESS system and MIDI.

■ Enter the Utility Mode

Press the [UTIL] button on the front panel.

Once the Utility Mode is entered, the System Group main page (LearnMode) shown below will be displayed.

UTIL



```
UT SYSTEM
LearnMode=allwys
```

* Double-click the [UTIL] button to enter the Utility Mode. The [4-1. Equalizer (EQ)] display will appear.

■ What's in the Utility Mode

The Utility Mode is divided into the 5 sub-groups listed below.

1. SYSTEM Group (→P. 52)

Contains various settings that affect the entire DTXPRESS system.

2. MIDI Group (→P. 53)

Contains various settings for the DTXPRESS' MIDI and TO HOST functions.

3. SEQ (Sequencer) Group (→P. 56)

Contains various settings that apply to the DTXPRESS' sequencer (song).

4. TG (Tone Generator) Group (→P. 58)

Contains various settings that apply to the DTXPRESS' tone generator.

5. MAP (Drum Map) Group (→P. 59)

Used to edit the User Drum Map.

How to set...

1. Press the [UTIL] button to enter the Utility Mode.
2. Select the sub-mode.
 - Press the [UTIL] button to move to the next sub group's main page.
 - Use the [PAGE▲], [PAGE▼] buttons to move to page by page within the selected sub group. You can use these buttons to navigate through all of the pages (from the first System Group main page to the last MAP Group page).
3. Use the [SEL◀], [SEL▶] buttons to move the cursor to the setting you want to change. The value will flash.
 - * If there is only one parameter, it is not necessary to move the cursor.
4. Use the [VALUE-] and [VALUE+] buttons to set the parameter's value or ON/OFF setting.

Any settings made in the Utility Mode will directly change the memory settings of the DTXPRESS. There is no store function in this mode.

Utility Mode Function List

	Page
1. SYSTEM Group	52
1-1. Learn Mode	52
1-2. Trigger Bypass	52
1-3. Volume Mode	52
1-4. Jump to Recent Page	52
1-5. Hi-Hat Offset	53
1-6. Factory Set	53
2. MIDI Group	53
2-1. Bulk Dump	53
2-2. Channel 10 Program Change/ Channel Event Receive	54
2-3. Receive Program Change/ System Exclusive Messages	54
2-4. Program Change Table	55
2-5. MIDI Mode	55
2-6. Device Number, Local Control	55
2-7. MIDI Merge	55
2-8. Dump Interval	56
2-9. Send Hi-Hat Control	56
2-10. Host Thru Port	56
3. Sequencer Group	56
3-1. Click Voice	56
3-2. Click Tune	57
3-3. Click Note Number	57
3-4. MIDI Control	57
3-5. Count Switch	57
3-6. Sync Mode	57
3-7. Use Tempo	58
3-8. Click Mode	58
4. TG (Tone Generator) Group	58
4-1. Equalizer (EQ)	58
4-2. Tuning	58
4-3. Volume	58
4-4. Reverb Bypass	59
5. MAP (Drum Map) Group	59
5-1. Voice	59
5-2. Volume, Pan	60
5-3. Tuning	60
5-4. Layer Balance	60
5-5. Decay, Cutoff Frequency	60
5-6. Reverb Send	60
5-7. Alternate Group, Key Assign Mode	61
5-8. Key Off Enable	61
5-9. Map Copy	61

1. SYSTEM Group

This sub-mode contains settings that relate to the overall DTXPRESS system. The group is divided into the following 6 pages.

- 1-1. Learn Mode 52
- 1-2. Trigger Bypass 52
- 1-3. Volume Mode 52
- 1-4. Jump to Recent Page 52
- 1-5. Hi-Hat Offset 53
- 1-6. Factory Set 53

1-1. Learn Mode

This function allows selection of the pad (trigger input) you want to edit by hitting the pad when you are editing in the Trigger Setup Edit mode or Drum Kit Edit mode. Also, MIDI key on input from the MIDI IN/TO HOST jack can be used to appoint the MIDI note number in the Utility mode's User Map Setting.

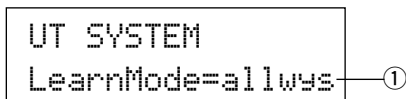

① LearnMode

- allwys:** Always appoints according to pad/key on input.
- shift:** Hitting a pad or key on input while holding the [SHIFT] button selects the pad or note.
- none:** Can't appoint according to pad/key on input.

1-2. Trigger Bypass

This function prohibits reception of pad signals from pads (the hi-hat controller too) connected to the DTXPRESS. You will not be able to produce voices or transmit MIDI data. The sequencer and tone generator will function normally.

HINT Use this function when you are setting your drum kit with trigger pickup devices, or when you do not want to accidentally make a sound during song playback.

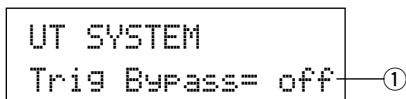

① Trig Bypass

- off:** Bypasses the trigger (does not receive).
- on:** The trigger functions normally (receives trigger).

1-3. Volume Mode

Sets the ACCOMP. VOL knob and CLICK VOL knob on the front panel.

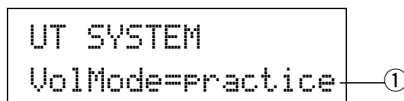

① VolMode (Volume Mode)

- **Practice:** When set to the practice mode.
 - [ACCOMP. VOL]
 - Using the [ACCOMP. VOL] knob as is will adjust the volume of the song accompaniment.
 - Holding the [SHIFT] button while turning the knob will adjust the snare drum volume.
 - [CLICK VOL]
 - Using the [CLICK VOL] knob as is will adjust the volume of the metronome click.
 - Holding the [SHIFT] button while turning the knob will adjust the bass drum volume.
- **live:** When set to the Live mode.
 - [ACCOMP. VOL]
 - Using the [ACCOMP. VOL] knob as is will adjust the snare drum volume.
 - Holding the [SHIFT] button while turning the knob will adjust the cymbal volume.
 - [CLICK VOL]
 - Using the CLICK VOL knob as is will adjust the bass drum volume.
 - Holding the [SHIFT] button while turning the knob will adjust the volume of the drum's other instruments.

1-4. Jump to Recent Page

This function lets you display the page last selected in the previous edit of the Trigger Setup Edit mode and Drum Kit Edit mode.

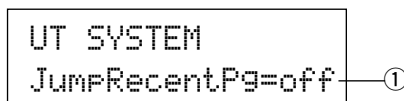

① JumpRecentPg (Jump to Recent Page)

- on:** The display page last selected in the previous edit will appear when you enter the Trigger Setup Edit, Drum Kit Edit, Utility and Song Job modes.
- off:** The main page of each mode will be displayed.

1-5. Hi-Hat Offset

This sets the value of the data sent by a foot controller connected to the HI HAT CONTROL jack on the rear panel. Set a + (plus) or - (minus) level.

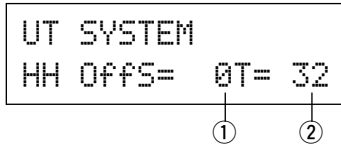

① HH OFFS (Hi-Hat Offset)

When a low data value is received from the foot controller, the voice will sound sooner. So, slightly pressing the foot controller will result in the voice sounding. In the case of the hi-hat controller, delicate adjustment of the controller's "closed" point is possible.

② T (Foot Splash Detect Time)

Sets the detect time for the foot splash. Large values make foot splashes easier to produce.

* Values too large will result in splashes being produced under normal hi-hat use.

1-6. Factory Set

This function replaces all internal settings in the DTXPRESS to their factory-set condition.

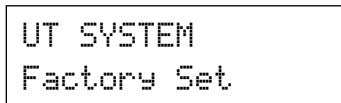

The Factory Set function will replace all internal settings in the DTXPRESS to their factory-set condition. Take care so as not to lose important data. Make sure any settings and user songs you want to keep have been saved to an external device such as the Yamaha MIDI Data Filer MDF3, etc. (→[2-1. Bulk Dump] (P. 53))

Procedure

1. Enter the display shown above, press the [SAVE/ENT] button. The following display will appear asking for confirmation before the Factory Set operation is carried out.

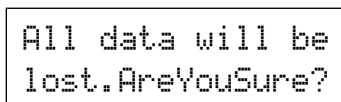

2. Once again, press the [SAVE/ENT] button to proceed with the operation.

2. MIDI Group

This sub-mode contains functions and settings for the MIDI and TO HOST jacks of the DTXPRESS. This group is divided into the following 10 pages.

- 2-1. Bulk Dump 53
- 2-2. Channel 10 Program Change/
Channel Event Receive 54
- 2-3. Receive Program Change/
System Exclusive Messages 54
- 2-4. Program Change Table 55
- 2-5. MIDI Mode 55
- 2-6. Device Number, Local Control 55
- 2-7. MIDI Merge 55
- 2-8. Dump Interval 56
- 2-9. Send Hi-Hat Control 56
- 2-10. Host Thru Port 56

* Please refer to the [MIDI Data Format] (P. 80) section for more information related to MIDI.

2-1. Bulk Dump

With the Bulk Dump operation, data stored in the DTXPRESS can be transmitted via the MIDI OUT or TO HOST jack.

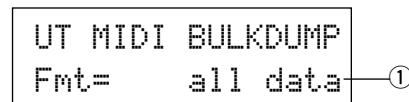

① Fmt (Bulk Dump Format)

Selects the type of data to be transmitted with the Bulk Dump operation.

- all data : All the data in the DTXPRESS
- system data : Data set in the Utility mode (except User Map).
- user map : User Map data.
- one drumkit : Data for the currently selected Drum Kit.
- all drumkit : All User Drum Kit Data.
- one trigger : Data for the currently selected Trigger Setup.
- all trigger : All User Trigger Setup data
- one song : Data for the currently selected User Song.
- all song : All User Song data.

Procedure

1. After reading the [Connecting a MIDI Device] (P. 12) or the [Connecting a Computer] (P. 26) section, connect the external MIDI device or computer to the MIDI OUT or TO HOST jack on the DTXPRESS. Set the HOST SELECT switch.

Utility Mode

2. Select the type of bulk data (that will be sent) in the display shown above and press the [SAVE/ENT] button. The display shown below will appear.

```
BULK    all data
Are you sure ?
```

3. Press the [SAVE/ENT] or [VALUE+] button, the bulk dump will be carried out.

- * Press [VALUE-] to cancel the bulk dump. When the operation is complete, the LCD will display "Complete" as shown below.

```
Complete !
```

- * The device number must be set for bulk dumps [2-6. Device Number, Local Control] (P. 55)
- * Refer to the [MIDI Data Format] section (P. 80) for more information on bulk dump operations.

Receiving Bulk Data

DTXPRESS data stored in an external device can be sent back to the DTXPRESS' MIDI IN/TO HOST jack using Bulk Data Receive.

1. After reading the [Connecting a MIDI Device] (P. 12) or the [Connecting a Computer] (P. 26) section, connect the MIDI device or computer to the MIDI OUT jack/TO HOST jack on the DTXPRESS. Set the HOST SELECT switch.
2. With the sequencer (song, metronome) stopped, send bulk data from the external device.
3. When the DTXPRESS starts receiving data, the following screen will appear on the LCD.

```
BULK Receiving
Please wait...
```

4. When the DTXPRESS has completed receiving all the data, the following screen will appear on the LCD for a few seconds, then the screen will return to the original display (before receiving bulk data).

```
BULK Received.
```

- * Before receiving bulk data, it is necessary to match the device numbers (P. 55 [2-6]) of the DTXPRESS and the external device. It is also necessary to enable the DTXPRESS to receive exclusive messages (P. 54 [2-3]).

2-2. Channel 10 Program Change/Channel Event Receive

This enables or disables the DTXPRESS to receive program change messages/channel events through MIDI channel 10. Program change messages received or transmitted through channel 10 can be used to switch DTXPRESS drum kits.

It is necessary to set the receive parameter to "on" in this display in order to switch the DTXPRESS' drum kits from a song or an external MIDI device.

```
UT MIDI RECEIVE
10PC= on  10= on
```

① ②

① 10PC (Receive Program Change)

This enables or disables the DTXPRESS to receive program change messages through MIDI channel 10.

off: Does not receive.

on: Receives.

- * Even if the ① 10PC parameter is set to "on", program change messages from MIDI channel 10 will not be received in the following cases.

- If the ② 10 (receive channel event) parameter is set to "off"
- If the [2-3. Receive Program Change/System Exclusive Message's] ① PC (program change) parameter is set to "off".

② 10 (Receive Channel Event)

This enables or disables the DTXPRESS to receive MIDI channel messages through MIDI channel 10.

off: Does not receive.

on: Receives.

2-3. Receive Program Change/System Exclusive Messages

This enables or disables the DTXPRESS to receive program change messages/system exclusive messages from all MIDI channels.

```
UT MIDI RECEIVE
PC= on  SySEx= on
```

① ②

① PC (Receive Program Change)

off: Does not receive program change messages.

on: Receives program change messages.

② SySEx (Receive System Exclusive Messages)

off: Does not receive system exclusive messages.

on: Receives system exclusive messages.

2-4. Program Change Table

Use this function to create a program change table (a list of program change numbers that correspond to drum kits).

A program change message received internally from the DTXPRESS or through channel 10 from an external MIDI device will select, according to the program change table, the drum kit corresponding to the kit number in the DTXPRESS.

```

UT MIDI PC TABLE
No=  1-> kit 56
  
```

① ②

① No (Program Change Number)

Sets the program change number (1-128).

When the program change number set in this parameter is received, the corresponding drum kit number that is set in the following “kit” parameter will be selected.

② kit (Drum Kit Number)

Sets the drum kit number (1-80).

If this parameter is set to “none” the DTXPRESS will not respond, even when a program change message is received.

- * When the drum kit is changed with the DTXPRESS, the program change set in this function will be transmitted through MIDI channel 10. However, when a program change number is not assigned, it will not transmit.
- * When the following [2-5. MIDI Mode] is set to GM, receiving program changes will be limited.

2-5. MIDI Mode

This sub-group contains settings related to the MIDI IN jack and TO HOST input jack that affect tone generator events.

```

UT MIDI SETUP
MIDI Mode=native ①
  
```

① MIDI Mode

native: Recognizes all program changes for the drum voice.

GM: Drum voice pan is reversed so you will hear the drums as if you are sitting in the audience, the hi-hat will be heard on the right side. The following drum voice program changes are recognized. 1, 2, 9, 17, 25, 26, 33, 41, 50

2-6. Device Number, Local Control

Sets the MIDI device number and local control.

```

UT MIDI SETUP
DevNo=ALLocl= on
  
```

① ②

① DevNo (Device Number)

Sets the MIDI device number (1-16).

Bulk dumps will be transmitted with this device number.

Only data corresponding to this device number will be recognized when received.

If this is set to “ALL”, the device number will be “1” for transmitting data and data will be received from all device numbers.

② Loc1 (Local Control)

Switches Local Control ON or OFF.

off: MIDI signals triggered by the connected pads is disconnected from the DTXPRESS’ tone generator, there will be no sound produced by the DTXPRESS’ tone generator. The DTXPRESS will transmit MIDI signals from the MIDI OUT jack and TO HOST jack.

on: Normal operation. MIDI signals will be transmitted to the DTXPRESS’ tone generator as well as the MIDI OUT and TO HOST jacks.

2-7. MIDI Merge

Sets the MIDI Merge function ON or OFF. When this function is ON, data received from an external MIDI device connected to the MIDI IN jack will be mixed with internal MIDI data from the DTXPRESS and transmitted from the DTXPRESS’ MIDI OUT jack.

```

UT MIDI SETUP
Merge Output=off ①
  
```

① Merge Output (Merge Out)

on: Sends signals to the MIDI OUT jack.

off: Does not send signal to the MIDI OUT jack (internal operation only). Normal operation.



Connecting the MIDI IN/OUT jacks on a single device and setting MIDI Merge to “on” will result in a signal loop that may cause notes to sound (play) continuously.

2-8. Dump Interval

This sets the length of intervals between the packets of MIDI data sent by the DTXPRESS Bulk Out function. The intervals can be adjusted to the capacity of the external receiving MIDI device to prevent data overflow.

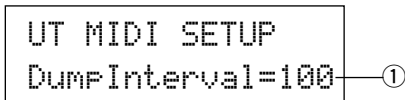

- ① **DumpInterval (Dump Interval)**
[Range] 50, 100, 150, 200, 250, 300 (in msec.)

2-9. Send Hi-Hat Control

This sets whether or not hi-hat controller events will be transmitted from the MIDI OUT jack or TO HOST jack.

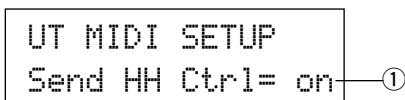

- ① **Send HH Ctrl (Send Hi-Hat Control)**
on: Sends data to the MIDI OUT jack and TO HOST jack.
off: Does not send data to the MIDI OUT jack and TO HOST jack.
* This setting does not affect internal operating data for the hi-hat controller.

2-10. Host Thru Port

This enables the DTXPRESS to transmit multi-port type messages received from the TO HOST jack. Only messages corresponding to the set port number will be sent via MIDI.

- * This setting only has affect when the TO HOST switch is set to a position other than "MIDI".

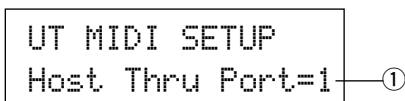

- ① **Host Thru Port**
Assigns the Port Number (1-8).

3. Sequencer Group

This sub-mode contains settings that relate to the sequencer (song). This group is divided into the following 8 pages.

3-1. Click Voice	56
3-2. Click Tune	57
3-3. Click Note Number	57
3-4. MIDI Control	57
3-5. Count Switch	57
3-6. Sync Mode	57
3-7. Use Tempo	58
3-8. Click Mode	58

3-1. Click Voice

This function sets each of the 3 click voices used for the click sound. Drum voices are assigned.

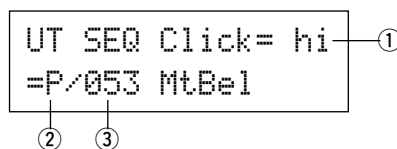

- ① **Click (Click Voice)**
Select and set the Click Voice for the click sound.
hi: Used for the click at the beginning of the measure.
mid: Used for quarter note beats.
lo: Used for other clicks for notes of smaller quantization.

- ② **Voice Category**
[Range] K, k, S, s, T, t, C, H, P, E, e, L, m
Sets the voice to be used for the Click Voice selected in step ①
Click, select a drum voice category.
Refer to Drum Kit Voice Edit Mode's [1-1. Voice] (P. 41).

- ③ **Voice Number Voice Name**
[Range] 0, 1-127
Selects the voice that will be assigned. The Voice Number (1-127) and Voice Name will be displayed.
If this parameter is set to "0", "NoAssign" will appear on the display and sound will not be produced.
* Refer to the [Drum Voice List] (P. 68).

3-2. Click Tune

This sets the pitch for each of the 3 Click Voices.

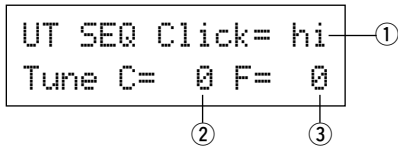

① Click (Click Voice)

Selects the Click Voice. (The same Click Voice selected in function 3-1.)

② Tune C (Tune Coarse)

[Range] -24 to 0 to +24.

The Click Voice selected in step ① will be tuned in increments of a half-step.

③ Tune F (Tune Fine)

[Range] -64 to 0 to +63.

The Click Voice selected in step ① will be tuned in increments of about 1.17 cents.

3-3. Click Note Number

Sets the MIDI Note Number for each of the 3 Click Voices.

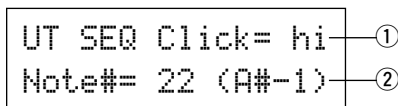

① Click (Click Voice)

Selects the Click Voice. (The same Click Voice selected in function 3-1.)

② Note # (MIDI Note Number)

[Range] off, 1-127 (—, C#-2 to G8)

Sets the MIDI note number. The note number and note name will be displayed.

If this is set to “off”, the DTXPRESS will produce sound however; key on messages will not be transmitted.

* Refer to the preset drum kit's [Drum Voice List] (P. 68) for the voice assignment of each MIDI note number.

3-4. MIDI Control

This enables or disables the DTXPRESS to transmit or receive system real-time messages (start/continue/stop).

When this function is enabled, you can control an external sequencer or rhythm machine from the DTXPRESS. Control of the DTXPRESS from an external sequencer or rhythm machine is also possible.

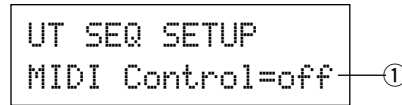

① MIDI Control

on: Transmits and receives the following system real-time messages.

- Transmits timing clock (F8) (transmit only)
- Transmits and receives start, stop, and continue (FA, FB, FC)

off: Does not transmit or receive system real-time messages.

3-5. Count Switch

This function turns the 2 bar countdown before the song starts playback, on or off.

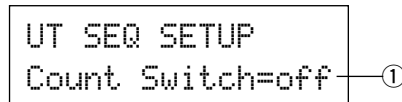

① Count Switch

on: After a 2 bar countdown, the song will start playback.

off: No countdown, the song will start playback immediately.

3-6. Sync Mode

This function synchronizes the DTXPRESS sequencer's clock with the clock of an external device.

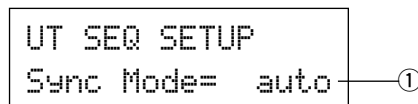

① Sync Mode

int: Movement is determined by the DTXPRESS' internal clock.

ext: Movement is determined by the clock of an external device received via the MIDI IN/TO HOST jacks.

auto: If a timing clock (F8) is received via the MIDI IN/TO HOST jack the external clock will be used. If a timing clock (F8) is not received the internal clock will be used.

3-7. Use Tempo

This function sets the tempo of a song to either change each time to its default tempo, or remain unchanged at the currently set tempo when the song is switched.

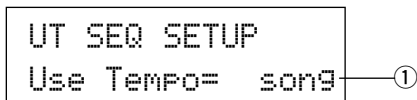

① Use Tempo

song: Changes the tempo of the song to its default tempo when the song is switched.

global: The tempo remains unchanged at the currently set tempo when the song is switched.

3-8. Click Mode

This sets whether or not the click voice will automatically sound during song playback.

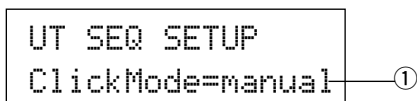

① ClickMode (Click Mode)

manual: The [CLICK] button will control on/off operation of the click sound.

sync: The click will sound during song playback, but will not sound when the song is stopped. The [CLICK] button can also be used to control on/off operation of the click sound.

4. TG (Tone Generator) Group

This sub-mode contains settings for the DTXPRESS' tone generator. This group is divided into the following 4 pages.

- 4-1. Equalizer (EQ) 58
- 4-2. Tuning 58
- 4-3. Volume 58
- 4-4. Reverb Bypass 59

4-1. Equalizer (EQ)

Sets the Master Equalizer (2-band shelving type).

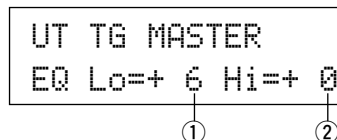

① EQ Lo (Low Gain)

[Range] +0 to +12 (dB)

② EQ Hi (High Gain)

[Range] +0 to +12 (dB)

4-2. Tuning

This function sets the master tuning of the tone generator.

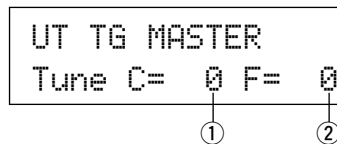

① Tune C (Tune Coarse)

[Range] -24 to 0 to +24

Tuning can be set in increments of a half step.

② Tune F (Tune Fine)

[Range] -64 to 0 to +63

Tuning can be set in increments of about 1.17 cents.

4-3. Volume

This function sets the overall volume level of the tone generator.

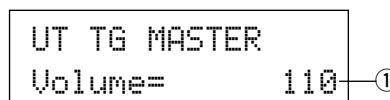

① Volume

[Range] 0-127

4-4. Reverb Bypass

This function decides whether to bypass the system effect's reverb or not.

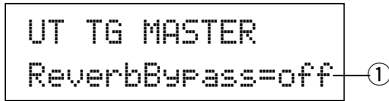

① ReverbBypass (Reverb Bypass)

off: Does not bypass (functions). Normal operation.
on: Bypasses. Reverb will not be applied to the voice.

5. MAP (Drum Map) Group

This sub-mode is used to edit the User Drum Map. This mode is divided into the following 9 pages.

- 5-1. Voice 59
- 5-2. Volume, Pan 60
- 5-3. Tuning 60
- 5-4. Layer Balance 60
- 5-5. Decay, Cutoff Frequency 60
- 5-6. Reverb Send 60
- 5-7. Alternate Group, Key Assign Mode 61
- 5-8. Key Off Enable 61
- 5-9. Map Copy 61

* When a User Drum Kit (No. 49-80) is selected, the User Drum Map is the data that is used to set the note number's voice, etc., that is not assigned to the drum kit's pad input. Therefore, when a preset drum kit is selected the User Drum Map will not be used (the preset drum map will be used) so settings for functions [5-1] to [5-8] that appear in the display can not be carried out.

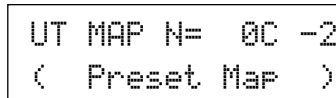

Also, settings cannot be carried out for the following functions [5-1] to [5-8] when the note numbers for the currently selected drum kit are already assigned/set.

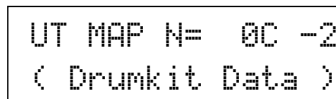

5-1. Voice

This creates a list that assigns a drum voice for each MIDI note number. Which MIDI note number ① will be received and which drum voice ② will be sounded.

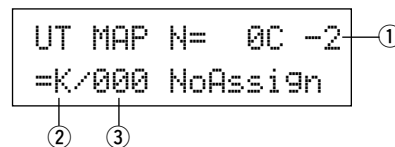

① N (MIDI Note Number)

[Range] 0-127 (C-2 to G8)

Sets the MIDI note number. Displays the note number and note name.

* According to the setting of the Utility mode's [1-1. Learn Mode] (P. 52) you can appoint the MIDI note number with key on input from the MIDI IN/TO HOST jacks.

② Voice Category

[Range] K, k, S, s, T, t, C, H, P, E, e, L, m

Selects the drum voice category.

Refer to Drum Kit Voice Edit Mode's [1-1. Voice] (P. 41).

Utility Mode

③ Voice Number Voice Name

[Range] 0, 1-127

Selects the assigned voice. Displays the voice number (1-127) and voice name.

If this parameter is set to "0", "NoAssign" will appear in the display and sound will not be produced.

* Refer to the [Drum Voice List] (P. 68).

5-2. Volume, Pan

This function sets the volume ② and pan ③ (the position in the stereo field) for each drum voice assigned to each MIDI note number ①.

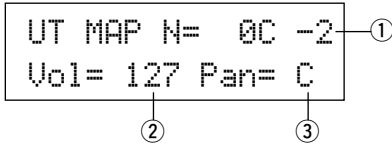

① N (MIDI Note Number)

Selects the MIDI note number (The same procedure as in [5-1. Voice]).

② Vol (Volume)

[Range] 0-127

③ Pan

[Range] L64 to C to R64.

5-3. Tuning

This function sets the pitch for each drum voice assigned to each MIDI note number ①.

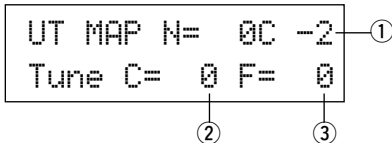

① N (MIDI Note Number)

Selects the MIDI note number (The same procedure as in [5-1. Voice]).

② TuneC (Tune Coarse)

[Range] -24 to 0 to +24

Tuning can be set in increments of a half step.

③ TuneF (Tune Fine)

[Range] -64 to 0 to +63

Tuning can be set in increments of 1.17 cents.

5-4. Layer Balance

When a drum voice assigned to a MIDI note number ① is made up of 2 layers (a single voice consisting of 2 voice waves), this function sets the volume balance between those 2 layers.

* When the selected voice only has a 1 layer, this setting will have no affect.



① N (MIDI Note Number)

Selects the MIDI note number (The same procedure as in [5-1. Voice]).

② LayerBalance (Layer Balance)

[Range] -64 to 0 to +63, ---

Selects the volume balance between the 2 layers.

* When the selected drum voice only has 1 layer, "---" will appear in the display and settings can not be carried out.

5-5. Decay, Cutoff Frequency

This function sets the drum voice decay, the filter's cutoff frequency and adjusts the tone of each voice assigned to each MIDI note number ①.

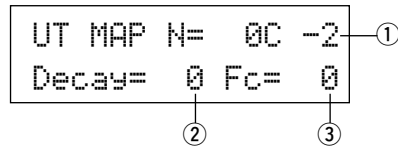

① N (MIDI Note Number)

Selects the MIDI note number (The same procedure as in [5-1. Voice]).

② Decay

[Range] -64 to 0 to +63.

Negative values will produce a clearer sound.

③ Fc (Cutoff Frequency)

[Range] -64 to 0 to +63

A positive value will produce a brighter sound, negative values will produce a rounder sound.

5-6. Reverb Send

This sets the Reverb Send Level ② for each drum voice assigned to each MIDI note number ①.

* The actual reverb send level will be determined by multiplying the Reverb Send Level set in [5-2. Drum Reverb Send] (P. 47) in the Drum Kit Voice Edit Mode.

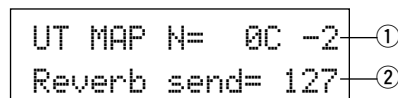

① N (MIDI Note Number)

Sets the MIDI note number (The same procedure as in [5-1. Voice]).

② Reverb send (Reverb Send Level)

[Range] 0-127

5-7. Alternate Group, Key Assign Mode

This sets the Alternate Group and Key Assign Mode for each drum voice ② assigned to each MIDI note number ①.

The function and setting of the Alternate Group, Key Assign Mode are the same functions and settings found in [2-3. Alternate Group, Key Assign Mode] (P.43) in the Drum Kit Voice Edit Mode.

```

UT MAP N= 0C -2 ①
AltG= 0 Key=semi ② ③
  
```

① N (MIDI Note Number)

Selects the MIDI note number (The same procedure as in [5-1. Voice]).

② AltG (Alternate Group)

[Range] 0-15

③ Key (Key Assign Mode)

[Range] poly, semi, mono, high

5-8. Key Off Enable

This function decides whether or not to recognize key off messages for each drum voice ② assigned to each MIDI note number ①.

```

UT MAP N= 0C -2 ①
Key Off= disable ②
  
```

① N (MIDI Note Number)

Selects the MIDI note number (The same procedure as in [5-1. Voice]).

② Key Off

enable: Recognizes key off.

disable: Does not recognize key off.

- * When this is set to "disable", some voices may sound continuously. Press the [SHIFT] and [VOICE] buttons to stop voices sounding.

5-9. Map Copy

This function copies the preset drum map's entire internal settings to a user drum map.

```

UT MAP Copy
from= 1Acoustic ①
  
```



When the Map Copy function is used, the user drum map's internal settings will be erased and replaced with the settings of the copy source. If you want to keep important user drum map settings, use the bulk dump operation and save the settings to an external device before executing the map copy.

① from (Preset Drum Map)

Selects the preset drum kit number (1-48) that will be the copy source. The drum kit number and drum kit name will be displayed.

Procedure

- In the display shown above, assign the copy source drum kit (drum map), press the [SAVE/ENT] button. The following display will appear asking for confirmation before the copy operation is carried out.

```

Copy Map From 1
Are you sure ?
  
```

- Press the [SAVE/ENT] or [VALUE+] button, the copy operation will be carried out.

* Press the [VALUE-] button to cancel the copy operation.

When the copy operation is complete, "Complete!" will appear.

MEMO

Appendix

This section contains lists for the DTXPRESS' internal Voice, Song, Trigger Setup as well as details related to MIDI and Error Messages.

Specifications	64
Error Messages	65
Trouble Shooting	66
Drum Voice List	68
GM Keyboard Voice List	72
Preset Drum Kit List	72
Preset Song List.....	79
Trigger Setup List	79
MIDI Data Format	80
MIDI Implementemation Chart	82
Index.....	83
Blank Chart.....	85

Specifications

Tone Generator	16 bit AWM2
Maximum polyphony	32
Voices	910 drum, percussion voices and effects 128 keyboard voices (GM system level 1)
Drum kits	48 Preset 32 User memory locations
Trigger setups	7 Preset 4 User memory locations
Sequencer tracks	2 (TR1, TR2)
Song control	
Main song	Start/Stop, note chase
Pad song	3 songs can be played at the same time, Trigger Control
Other Sequencer Functions	MIDI sync play, Quantize (while recording, in Song Edit job mode), Mute (rhythm mute, drum instrument mute), Groove Check
Song	95 Preset 32 User memory locations
Record modes	Real-time
Controls	
LED buttons	6 (PLAY, TRIGGER, UTILITY, VOICE, CLICK, SONG)
Buttons	9 (START/STOP, SAVE/ENTER, SHIFT, PAGE▲/▼, SELECT ◀/▶, VALUE-/+)
Knobs	MASTER VOLUME/POWER SW (push), ACCOMP. VOLUME, AUX VOLUME, CLICK VOLUME
Display	16 x 2 LCD display (w/Back light)
Connections	
Front Panel	Aux input (stereo mini jack) Head phone (stereo phone jack)
Rear Panel	MIDI input/output Foot controller (stereo phone jack) HOST SELECT SW TO HOST (mini DIN jack) Output L/MONO (mono phone jack) Output R (mono phone jack) Trigger Inputs 1 – 8 (stereo phone jack→L : trigger input, R : rim switch) Trigger Input 9/10 (stereo phone jack→L, R : trigger input) Trigger attenuation switch 1-6 (DIP SW)
Power supply	DC 12V/AC adaptor (PA-3B or PA-3C)
Power Requirement	4.8 Watt
Dimensions (W x H x D)	220 x 240 x 44 mm (8-11/16" x 9-3/16" x 1-5/16")
Weight	1.6 kg (3 lbs 8 oz)
Accessories	Owner's Manual AC adaptor

* Specifications and descriptions in this owner's manual are for information purposes only.

Yamaha Corp. reserves the right to change or modify products or specifications at any time without prior notice. Since specifications, equipment or options may not be the same in every locale, please check with your Yamaha dealer.

Error Messages

An Error Message will appear when incorrect settings or operation are detected, or abnormal operation occurs. Check the Error Message below and make the appropriate corrections.

ERROR
Data Initialized

This message appears just after the power is switched on and the device can not correctly read the data. The cause of the problem may be that the backup RAM data has been damaged or the backup battery power is low. Contact the nearest Yamaha Service Center or the dealer where you purchased the device.

WARNING
Battery Low

The internal memory backup battery power is too low. User data may be deleted. Contact the nearest Yamaha Service Center or the dealer where you purchased the device.

ERROR
MIDI Buffer full

Too much MIDI data is being received at one time and the device could not manage the data. Reduce the amount of data being sent at one time and try again.

ERROR
HOST is OffLine

The computer connected to the device is either turned off or not correctly connected. Check cable connections and the power and try again.

ERROR
Check Sum Error

The check sum for the data received is incorrect. Check the check sum of the data being transmitted.

ERROR
Illegal Data

An error occurred while data was being received. There may be abnormalities in the data being sent. Check the data being transmitted.

CAN'T EDIT
PRESET SONG

This message is displayed when you try to edit preset song. Preset song cannot be edited.

ERROR
SEQ is Running

The operation can't be performed while the sequencer is running. Stop the sequencer and try again.

ERROR
Data not Empty

This message appears if you try to record to a track containing data. Select an empty track and try recording again.

ERROR
Memory Full

You have exceeded the memory capacity of the user song. Delete unwanted songs to make more memory available and try recording again. At this time, use the bulk dump function to move any songs you wish to keep to an external MIDI device.

Trouble Shooting

The DTXPRESS does not produce sound, and does not recognize trigger inputs.

- Is the pad or trigger sensor properly connected to the DTXPRESS' trigger input jack? (→ P. 10)
- Is the volume knob on the front panel turned down? (→ P. 8)
- Is the input level displayed when the pad is hit? (→ P. 36 [1-2. Gain, Minimum Velocity])
- Is the gain set too low? (→ P. 36 [1-2. Gain, Minimum Velocity])
- Is the Utility mode's [1-2. Trigger Bypass] bypass switch set to "ON"? (→ P. 52)
- Is the Drum Kit Voice Edit mode's [1-2. Volume, Pan] (→ P. 41) or [5-1. Volume] (→ P. 47) volume set to "0"?
- Check the local control setting in the Utility mode. When the local control is set to "off" the DTXPRESS will not produce sound when the pads are hit. (→ P. 55 [2-6. Device Number, Local Control])
- Is the cable you are using OK?

The external tone generator does not produce sound.

- Is the MIDI cable (connector) properly connected? (→ P. 12)
- Are the MIDI note number values proper? (→ P. 42 [1-7. Channel, Gate Time])
- Is the Utility mode's [1-2. Trigger Bypass] bypass switch set to "ON"? (→ P. 52)

A voice other than the set voice is produced.

- Is the transmitting MIDI channel set to a channel that is not used for the drum voice (ch=10)? (→ P. 42 [1-7. Channel, Gate Time])
- Is the Voice=2 parameter set for a 2 layer voice? (→ P. 41 [1-1. Voice])

Produces sound but the sensitivity is too low (volume is low).

- Is the gain set too low? (→ P. 36 [1-2. Gain, Minimum Velocity])
- Pads with output or sensitivity control volumes should be adjusted (increased).
- Is the minimum velocity set too low? (→ P. 36 [1-2. Gain, Minimum Velocity])
- Is a proper velocity curve being used? (→ P. 37 [1-3. Velocity Curve])
- Is the volume of the voice you want to use too low? (→ P. 41 [1-2. Volume, Pan])
- Is the drum head getting old?
- Change the INPUT ATTENUATION setting on the rear panel. (→ P. 9)

The trigger sound is not stable (for acoustic drums).

- Check the "Produces sound but the sensitivity is too low (volume is low)." list above.
- Is the proper pad type set? Select a larger pad type setting (DT snare → DT hi tom → DT lo tom → DT kick 1 → DT kick 2) (→ P. 36 [1-1. Pad Type])
- Is the DT10 properly attached with sticky tape? (Is there any old sticky tape remaining on the head?) (→ P. 11)
- Is the cable securely connected to the DT10 jack?

Double-triggers are produced.

- Are you using a sensor made by a manufacturer other than Yamaha? If the signal is too large, double-triggers may be produced.
- Is the head causing irregular vibrations? It may be necessary to mute the head.
- Is the sensor attached close to the center of the head? Move the sensor closer to the rim (above the bearing). (→ P. 11)
- Is the sensor in contact with anything else?
- Pads with output or sensitivity control volumes should be adjusted (lowered).
- Try increasing the rejection parameter. However, a setting a value that is too high may cause the sound to be muted when another drum is hit at the same time. (→ P. 37 [1-4. Self-Rejection, Rejection])
- Use the self-rejection. (→ P. 37 [1-4. Self-Rejection, Rejection])
- Change the INPUT ATTENUATION setting on the rear panel. (→ P. 9)

Cross-talk is produced.

- Try placing the sensors (DT10, etc.) away from nearby drums.
- Is the gain set too high? (→ P. 36 [1-2. Gain, Minimum Velocity]).
- Try increasing the rejection parameter. However, a setting a value that is too high may cause the sound to be muted when another drum is hit at the same time. (→ P. 37 [1-4. Self-Rejection, Rejection])
- If cross-talk is produced with a specific trigger input, try using specific rejection. (→ P. 37 [1-5. Specific Rejection])

Sounds are cut when you play continuously.

- The maximum polyphony of 32 voices might be exceeded. In the Drum Kit Voice Edit mode's [2-3. Alternate Group, Key Assign Mode] (→ P. 43) set the "Key" value to "semi" or "mono".

When 2 pads (drums) are played only 1 sound is heard.

- Raise the gain setting of the pad (drum) that is not producing sound. (→ P. 36 [1-2. Gain, Minimum Velocity])
- Lower the rejection setting of the pad that is not producing sound. (→ P. 37 [1-4. Self-Rejection, Rejection])
- Are both pads assigned to the same group in the Drum Kit Voice Edit mode's [2-3. Alternate Group, Key Assign Mode] display (→ P. 43)?

The sound is always loud.

- Is the minimum velocities minimum value set too high? (→ P. 36 [1-2. Gain, Minimum Velocity])
- Are you using a proper velocity curve? (→ P. 37 [1-3. Velocity Curve])
- Are you using a sensor made by a manufacturer other than Yamaha? Depending upon the manufacturer output levels might be too large.
- Change the INPUT ATTENUATION setting on the rear panel. (→ P. 9)

The DTXPRESS does not receive any switch or trigger signals.

- If you can access the Utility mode, do a factory reset. The DTXPRESS will reset to its factory settings. (→ P. 53 [1-6. Factory Reset])
- Turn the [POWER SW] OFF then ON while holding the [PAGE▲] and [PAGE▼] buttons. The DTXPRESS will reset to its factory settings.

The sound will not stop.

- Some voices have very long release times when the [2-5. Key Off Enable] (→ P. 44) "key off" parameter is set to "disable". To temporarily stop the sound, hold the [SHIFT] button and press the [VOICE] button.

Drum Voice List

● Voice Category

K : Acoustic Kick
 k : Electric Kick
 S : Acoustic Snare
 s : Electric Snare
 T : Acoustic Tom
 t : Electric Tom
 C : Cymbal
 H : Hi-Hat
 P : Percussion
 E : Effect 1
 e : Effect 2
 L : Drum Loop
 m : misc. voices

● : 2-layer voice

K : Acoustic Kick

- 1 2HedMed1 ●
- 2 2HedMed2 ●
- 3 Basic ●
- 4 BD DRY 1
- 5 BD DRY 2
- 6 BD DRY 3
- 7 BD DRY 4
- 8 BD GMH
- 9 BD GMM
- 10 BD GMM2
- 11 BD NN04C
- 12 Bottom ●
- 13 Pointy ●
- 14 SoTight ●
- 15 BDbasc1
- 16 BD 24Dry
- 17 BDaffty1 ●
- 18 BDaffty2 ●
- 19 MapleA20
- 20 MapleV20
- 21 BDstomp1 ●
- 22 Bdvman ●
- 23 BigSofty ●
- 24 2HeadHi ●
- 25 BD DRYB1
- 26 BD GMJ
- 27 BD GML
- 28 BD ROOM2
- 29 BD ROOM5
- 30 MapleAmb
- 31 BD Soft
- 32 2HeadLo ●
- 33 BD MONDO
- 34 BDbasc2
- 35 BD KONG1
- 36 BDersko1 ●
- 37 Bushy ●
- 38 BD ROOM3
- 39 BDbonzo2 ●
- 40 BD GATE1
- 41 BD GATE2
- 42 BD GateM

- 43 BD Metal ●
- 44 BD Rock1
- 45 BD Rock2
- 46 BD ROOM4
- 47 VeloRoom ●
- 48 WudPoint ●
- 49 BDevolvr ●
- 50 BDpalmer ●
- 51 Roomy ●
- 52 GrCMute
- 53 GrnCassa

k : Electric Kick

- 1 AnaQuick
- 2 BD ELEC2
- 3 BD Rave6 ●
- 4 BD Rave7 ●
- 5 BD Rave8 ●
- 6 BDDance1
- 7 BDDance2
- 8 BDDance3
- 9 BDDance4
- 10 BDdance5 ●
- 11 BDDance6
- 12 BDDance9
- 13 BDlong1 ●
- 14 BDRave10
- 15 BDRave11 ●
- 16 Sub1
- 17 Sub2 ●
- 18 Sub3 ●
- 19 QuikBuzz
- 20 BD ELEC1
- 21 BDdigiro ●
- 22 BDFunky1 ●
- 23 BDindst1 ●
- 24 BDNIN1 ●
- 25 BDRevers
- 26 BDudu1 ●
- 27 BDurban1 ●
- 28 BDurban2 ●
- 29 BigBoy ●
- 30 MtlPoint ●
- 31 BDbass1 ●
- 32 Walkik ●
- 33 fefifom ●

S : Acoustic Snare

- 1 Loosy ●
- 2 LoosyRim ●
- 3 Barypic ●
- 4 Baryrim ●
- 5 Binky ●
- 6 MapleA50 ●
- 7 MickMHS ●
- 8 MapleV65 ●
- 9 Blu90Rim ●
- 10 Blue90
- 11 BrysnH
- 12 BrysnR
- 13 Drygyrim ●

- 14 Hip Hop
- 15 OldCan ●
- 16 SnareH
- 17 LiteSnr1 ●
- 18 Tosh Sn ●
- 19 MapleRim ●
- 20 BigWdRim ●
- 21 BigWood
- 22 Dry
- 23 Wood Sn
- 24 Wood65
- 25 ToshL fi ●
- 26 Looz Pic
- 27 PhlyRim ●
- 28 RIMhipop ●
- 29 LoosyP ●
- 30 SnareH2 ●
- 31 MickCJ8S ●
- 32 Maple12 ●
- 33 12Soprno
- 34 Picket ●
- 35 Slappy ●
- 36 BeatyRim
- 37 Beauty ●
- 38 BlastX ●
- 39 BrassRim
- 40 BuzRgRim ●
- 41 Buzzring ●
- 42 Jelyrim ●
- 43 MrcSnrH
- 44 MrcSnrM
- 45 RIMBrass ●
- 46 RIMetal ●
- 47 RIMnatrl ●
- 48 RIMouch! ●
- 49 RoldGold
- 50 SnareL2 ●
- 51 Steel ●
- 52 Sticky ●
- 53 VtgBras1
- 54 VtgBras2
- 55 MickDarS
- 56 BETA Sn ●
- 57 Brassy ●
- 58 Deep&Dry ●
- 59 MickOLD ●
- 60 Fat looz
- 61 RIMdry1 ●
- 62 Rock ●
- 63 SnareM
- 64 SnarDeep ●
- 65 BrassPic
- 66 DryMetal ●
- 67 PicloRim ●
- 68 BluePIC ●
- 69 Metalpic ●
- 70 ClubOK ●
- 71 ClubORrim
- 72 Piclodry ●
- 73 Fusion ●
- 74 TrashRIM ●
- 75 Amb 02

- 76 Ambient1 ●
- 77 Ambt1rim ●
- 78 Cool Dry ●
- 79 OpnRim ●
- 80 Powerpic ●
- 81 Pwrpcrim ●
- 82 Room ●
- 83 Amb 01
- 84 Ambient ●
- 85 ParadeS ●
- 86 Amb 03
- 87 AmbiRim ●
- 88 Nashvill ●
- 89 OpnRimA ●
- 90 OpnRimB ●
- 91 OpnRimC ●
- 92 OpnRimD ●
- 93 RIMrock ●
- 94 RIMwatts ●
- 95 Fatbrass
- 96 Fatbrim ●
- 97 Brass55 ●
- 98 Steel65 ●
- 99 Alumi55 ●
- 100 RoldRim ●
- 101 SAmbie1 ●
- 102 SAmbie2 ●
- 103 SAmbie3 ●
- 104 Gate
- 105 GhiGateSn ●
- 106 RockH
- 107 RockL
- 108 RockM
- 109 S SStck1
- 110 S SStck2
- 111 S SStck3
- 112 S STK_HT
- 113 SidRim ●
- 114 SidStick ●
- 115 Timbrim ●
- 116 SnrGhst ●
- 117 TambSnre ●
- 118 SnareLes ●
- 119 LesRim ●
- 120 Latinrim ●
- 121 SnRoll1*
- 122 SnRoll2*

s : Electric Snare

- 1 AnaDaRim ●
- 2 AnaDark
- 3 AnaHit ●
- 4 Analog H ●
- 5 Analog L ●
- 6 AnalogH1 ●
- 7 AnalogL1 ●
- 8 AnaTite
- 9 AnaWide
- 10 AnaWiRim ●
- 11 AnHitRim ●
- 12 AnSStick
- 13 Dance

- 14 Dance01
- 15 Dance02
- 16 Dance03
- 17 Dance05
- 18 Dance06
- 19 Elektrik
- 20 SAmbie4 ●
- 21 SAna1 ●
- 22 SAna2 ●
- 23 SAna3 ●
- 24 Brsh H
- 25 AnAirRim ●
- 26 CapGun ●
- 27 CapRim ●
- 28 Dryroom ●
- 29 Electric
- 30 HiFive
- 31 RIMpopr ●
- 32 Sambie6 ●
- 33 AnaAir ●
- 34 AnaBuzz ●
- 35 AnaBzRim ●
- 36 AnaMeRim ●
- 37 AnaMetal ●
- 38 AnaShh ●
- 39 AnaShRim ●
- 40 AnaSlegh ●
- 41 AnaSIRim ●
- 42 AnaVel ●
- 43 AnaWee ●
- 44 AnaWeRim ●
- 45 AnVelRim ●
- 46 ASOBI ●
- 47 Blaaaghf ●
- 48 Brsh2Rim ●
- 49 BrsUpRim ●
- 50 DanceP
- 51 Distort ●
- 52 Dry Guy ●
- 53 Elem1
- 54 Elem2
- 55 Elem3 ●
- 56 EltrcRIM ●
- 57 Eno rim ●
- 58 Enotype ●
- 59 Fact rim ●
- 60 Factory ●
- 61 Fantam ●
- 62 FantaRim ●
- 63 Filtroll ●
- 64 Filtrim ●
- 65 FX ●
- 66 FX rim ●
- 67 Hi5Rim ●
- 68 JelyRoll
- 69 Philydry ●
- 70 RIMshort ●
- 71 RO_S
- 72 RockRim ●
- 73 RollEm1 ●
- 74 RollEm2 ●
- 75 RollEm3

- 76 RollRim1 ●
- 77 RollRim2
- 78 RollRim3
- 79 Ruberbnd ●
- 80 S Gate1
- 81 S Gate2
- 82 S Gate3
- 83 S RuberS
- 84 Sddark! ●
- 85 SDdkrim ●
- 86 SDind58 ●
- 87 Sheetmtl
- 88 ShmtlrIm ●
- 89 Smacker ●
- 90 Snarf ●
- 91 SnarfRim ●
- 92 SteelRim ●
- 93 Tekk1
- 94 Tekk2
- 95 Tekk3
- 96 UnclAB ●
- 97 UnclARim ●
- 98 WackyEFX ●
- 99 Brsh1Rim ●
- 100 BrshAtak
- 101 BrshHit1
- 102 BrshHit2
- 103 BrshOp
- 104 BrshSc
- 105 BrshSlp
- 106 BrshSlpL
- 107 BrshSw
- 108 BrshSwep
- 109 BrshTap1
- 110 BrshTap2
- 111 BrshTap3
- 112 BrshTp
- 113 BrSwH*
- 114 BrSwL*
- 115 BrSwTime
- 116 BrSwTRim ●
- 117 S Brsh
- 118 Shotgun ●
- 119 tkattak! ●
- 120 Manycure ●

T : Acoustic Tom

- 1 Dry1 Hi
- 2 Dry1 Mid
- 3 Dry1 Lo
- 4 Dry1 Flr
- 5 DRY GM6
- 6 DRY GM5
- 7 DRY GM4
- 8 DRY GM3
- 9 DRY GM2
- 10 DRY GM1
- 11 Maple10
- 12 Maple12
- 13 Maple14
- 14 Maple16
- 15 Lite Hi ●

- 16 Lite Mid ●
- 17 Lite Lo ●
- 18 Lite Flr ●
- 19 Jazz Hi
- 20 Jazz Mid
- 21 Jazz Lo
- 22 Jazz Flr
- 23 BrshJzHi
- 24 BrshJzMd
- 25 BrshJzLo
- 26 BrshJzFl
- 27 BrshRkHi
- 28 BrshRkMd
- 29 BrshRkLo
- 30 BrshRkFl
- 31 TOMntrIH
- 32 TOMntrIM
- 33 TOMntrIL
- 34 TOMntrIF
- 35 Dry2 Hi
- 36 Dry2 Mid
- 37 Dry2 Lo
- 38 Dry2 Flr
- 39 Room3 Hi
- 40 Room3Mid ●
- 41 Room3 Lo ●
- 42 Room3Flr ●
- 43 RoomP H
- 44 RoomP M
- 45 RoomP L ●
- 46 RoomP F
- 47 RoomQH ●
- 48 RoomQM ●
- 49 RoomQL ●
- 50 RoomQF ●
- 51 Room 6 ●
- 52 Room 5 ●
- 53 Room 4 ●
- 54 Room 3 ●
- 55 Room 2 ●
- 56 Room 1 ●
- 57 Rock 6
- 58 Rock 5
- 59 Rock 4
- 60 Rock 3
- 61 Rock 2
- 62 Rock 1
- 63 SAmbTmH ●
- 64 SAmbTmM ●
- 65 SAmbTmL ●
- 66 SAmbTmF ●
- 67 AmbTomH
- 68 AmbTomM
- 69 AmbTomL
- 70 AmbTomF
- 71 ACTomH
- 72 ACTomM
- 73 ACTomL
- 74 ACTomF
- 75 Room1 Hi ●
- 76 Room1Mid ●
- 77 Room1 Lo ●

- 78 Room1Flr ●
- 79 Room2 Hi ●
- 80 Room2Mid ●
- 81 Room2 Lo ●
- 82 Room2Flr ●
- 83 Night H
- 84 Night M
- 85 Night L
- 86 Night F
- 87 TOMxfadH ●
- 88 TOMxfadM ●
- 89 TOMxfadL ●
- 90 TOMxfadF ●

t : Electric Tom

- 1 Ana 1Hi
- 2 Ana 1Mid
- 3 Ana 1Lo
- 4 Ana 1Flr
- 5 Ana 2Hi ●
- 6 Ana 2Mid ●
- 7 Ana 2Lo ●
- 8 Ana 2flr
- 9 AnlgTom6
- 10 AnlgTom5
- 11 AnlgTom4
- 12 AnlgTom3
- 13 AnlgTom2
- 14 AnlgTom1
- 15 TEKK 1H
- 16 TEKK 1M
- 17 TEKK 1L
- 18 TEKK 1F
- 19 TEKK 2H
- 20 TEKK 2M
- 21 TEKK 2L
- 22 TEKK 2F
- 23 TEKK 3H
- 24 TEKK 3M
- 25 TEKK 3L
- 26 TEKK 3F
- 27 AnaIndsH ●
- 28 AnaIndsM ●
- 29 AnaIndsL ●
- 30 AnaIndsF ●
- 31 E Tom6
- 32 E Tom5
- 33 E Tom4
- 34 E Tom3
- 35 E Tom2
- 36 E Tom1
- 37 HybridH ●
- 38 HybridM ●
- 39 HybridL ●
- 40 HybridF ●
- 41 ElectrcH
- 42 ElectrcM
- 43 ElectrcL
- 44 ElectrcF
- 45 Distrt H
- 46 Distrt M
- 47 Distrt L

Drum Voice List

- 48 Distrt F
- 49 ETMOORH
- 50 ETMOORM
- 51 ETMOORL
- 52 ETMOORXL
- 53 IndTmH ●
- 54 IndTmM ●
- 55 IndTmL ●
- 56 IndTmF ●
- 57 TM Revrs
- 58 Analog
- 59 T GongE

C : Cymbal

- 1 CrashB
- 2 BriteCrs
- 3 C Crash
- 4 C CrshAC
- 5 CrshDRK
- 6 DeepDRK
- 7 FasCrash ●
- 8 FastCras
- 9 PaperThn
- 10 ReverseC
- 11 SoftRoll
- 12 C CrshSi ●
- 13 C FX02
- 14 DeepCym ●
- 15 FlatTop ●
- 16 RideDark
- 17 Ridedrk ●
- 18 Ride'EM ●
- 19 RideLite
- 20 Rider3 ●
- 21 RideRock
- 22 RideRock
- 23 RidesizA ●
- 24 RidesizB ●
- 25 RidesizC ●
- 26 RideXfd ●
- 27 RocksizL ●
- 28 SizzlDrk ●
- 29 Sizzler ●
- 30 SizzlLit ●
- 31 SizzlRck ●
- 32 RidB Lit
- 33 Bell A
- 34 BellTip
- 35 RidB Drk
- 36 RidB Rc
- 37 China
- 38 ChinaHi
- 39 MinChina
- 40 Clusher ●
- 41 C Splsh1
- 42 C Splsh2
- 43 C FX01
- 44 AngCym
- 45 Ride Anl
- 46 HCym1
- 47 HCym2 ●
- 48 HCymClL

- 49 HCymClM
- 50 HCymOpnL
- 51 HCymOpnM

H : Hi-Hat

- 1 H Cls01
- 2 H Cls13
- 3 H ClsA1
- 4 H ClsA2
- 5 H ClsMu
- 6 H ClsNB1
- 7 H ClsTc1
- 8 H ClsTc3
- 9 H QOPMu
- 10 H QOpn13
- 11 H TiCls1
- 12 H TiCls2
- 13 HHcl2Xfd ●
- 14 HHclsXfd ●
- 15 HHRoKcls
- 16 HH32cls ●
- 17 HHbrtcls ●
- 18 H OPMu
- 19 H Opn13
- 20 H OpnDW ●
- 21 H OpnDWX ●
- 22 H OpnL1 ●
- 23 H OpnL2 ●
- 24 H OpnL3 ●
- 25 H OpnLK ●
- 26 H OpnLX1 ●
- 27 H OpnMU ●
- 28 H OpnNB
- 29 HHRoKopn
- 30 HHopen#1 ●
- 31 H Pdl13
- 32 H PdlDW
- 33 H PdlLit ●
- 34 H PdlMu
- 35 H PdlNB
- 36 H PdTit
- 37 HHFTpdl1
- 38 Hpdcls1 ●
- 39 Hpdcls2 ●
- 40 Hpdcls3 ●
- 41 Hpdcls4 ●
- 42 FTsplRK
- 43 FTsplRK2 ●
- 44 FTsplsh1
- 45 FTsplsh2 ●
- 46 H SplNB
- 47 H Splsh
- 48 Hpsplsh1 ●
- 49 H OpnAMu
- 50 H OpnAn
- 51 H OpnLA1 ●
- 52 H OpnLA2 ●

P : Percussion

- 1 AgogoCh
- 2 AgogoH1

- 3 AgogoH2
- 4 AnCongaM
- 5 AnCowbll
- 6 AnMaracs ●
- 7 ATR
- 8 BassDr
- 9 Bell
- 10 Bell Tree
- 11 Bongo Hi
- 12 Bongo Lo
- 13 Bongo Mu
- 14 Cabasa1
- 15 Cabasa2 ●
- 16 Castanet
- 17 Clap8
- 18 ClapA
- 19 Clvs
- 20 ClvsA
- 21 Conga
- 22 Conga8H
- 23 CongaC
- 24 CongaG
- 25 CongaH
- 26 CongaM
- 27 CongaMV
- 28 CongAn
- 29 CongaO
- 30 CongaS
- 31 CongBe
- 32 CongC7
- 33 CowB1
- 34 CowB2
- 35 CowBAn
- 36 CowBM
- 37 CuicaH
- 38 CuicaL
- 39 EthWB
- 40 FSNap2
- 41 GONG
- 42 GranC
- 43 Guiro
- 44 GuiSht
- 45 HiQ
- 46 JingBell
- 47 Kalmb
- 48 Log H
- 49 Log L
- 50 Maracas1 ●
- 51 Maracas2
- 52 Maracas3
- 53 MtBel
- 54 Mtron
- 55 Scrach
- 56 Shake1
- 57 Shake2
- 58 ShakeA
- 59 SIBell
- 60 Surdo
- 61 SurdoM
- 62 Tabla B
- 63 Tabla BL
- 64 Tabla BM

- 65 Tabla BV
- 66 Tabla OV
- 67 TablaH
- 68 TablaM
- 69 TablaN
- 70 TablaO
- 71 Taiko
- 72 TalkD
- 73 TalknDrD
- 74 TalknDrU
- 75 TalknDrV
- 76 TambA
- 77 TambHH ●
- 78 Tambour
- 79 Tambrn
- 80 Timb
- 81 TimbH
- 82 TimbL
- 83 TimCas
- 84 TimpH
- 85 TimpL
- 86 Triang
- 87 TriMut
- 88 Udo F
- 89 Udo H
- 90 Udo L
- 91 Udu808H ●
- 92 Udu808L ●
- 93 VibrSlap
- 94 WCHim
- 95 Whist
- 96 WHP
- 97 WoodBloc
- 98 XfadeTri ●
- 99 SWhistH*
- 100 SWhistL*

E : Effect 1

- 1 6AMBreth ●
- 2 Ambush ●
- 3 AMRhythm ●
- 4 Applau ●
- 5 Bird
- 6 Bird-P
- 7 Bottle
- 8 BreakOut
- 9 BrsHit
- 10 BuzzyWak ●
- 11 C Crash
- 12 CarPss
- 13 CBRadi
- 14 ComVc
- 15 CoolSA
- 16 Creature ●
- 17 Crush
- 18 CStart
- 19 Didger
- 20 Dog
- 21 DogHats
- 22 Door
- 23 DSqrm
- 24 FM Met

- 25 FStep
- 26 Funky
- 27 Gargoyle ●
- 28 Glass1
- 29 Gun 1
- 30 Gun 2
- 31 Gun 3
- 32 HaHoHee ●
- 33 HandyDad ●
- 34 HandySon ●
- 35 Heli
- 36 HipNs
- 37 INDbells ●
- 38 INDchina
- 39 INDconga ●
- 40 INDcrash
- 41 InddogCR ●
- 42 INDhihat ●
- 43 INDrave ●
- 44 INDride ●
- 45 INDride2 ●
- 46 INDride3
- 47 INDshakr ●
- 48 Indust
- 49 InsAmb
- 50 Laugh
- 51 LoMo
- 52 MetalDip ●
- 53 MotoM
- 54 Motor
- 55 NoyzEB ●
- 56 OOOWWW
- 57 OrchSmsh ●
- 58 OrcHt1
- 59 OrcHt2
- 60 PAD
- 61 RatlBoom ●
- 62 RaveRide ●
- 63 RaveWave ●
- 64 Reverse ●
- 65 Ring
- 66 RubbrOil
- 67 Scream
- 68 Seasho
- 69 Shazam! ●
- 70 SlikRoad ●
- 71 SloSprkl ●
- 72 Stream
- 73 TablaX ●
- 74 TakeOff ●
- 75 TekGt
- 76 Thundr
- 77 TimbTimp ●
- 78 TineDrum ●
- 79 Tire
- 80 TungDrum ●
- 81 TV vo
- 82 TymKeepr ●
- 83 USS
- 84 VocIshKR ●
- 85 WetMetal ●
- 86 Yadee

e : Effect 2

- 1 JNGLSN1 ●
- 2 JNGLSN2 ●
- 3 JNGLSN3 ●
- 4 JNGLSN4 ●
- 5 JNGLSN5 ●
- 6 JNGLSN6 ●
- 7 JNGLSN7 ●
- 8 JNGLSN8
- 9 JNGLSN9 ●
- 10 JNGLSN10
- 11 JNGBASS! ●
- 12 JNGBASS2 ●
- 13 JNGBASS3 ●
- 14 JNGBASS4 ●
- 15 JNGBASS5 ●
- 16 JNGBASS6 ●
- 17 JNGBASS7 ●
- 18 JNGBASS8 ●
- 19 GUMYBASS ●
- 20 BDSUBSNK ●
- 21 TENDO ●
- 22 SPIKER ●
- 23 PULSAR
- 24 PULSAR2 ●
- 25 PULSAR3 ●
- 26 DALIBAS1 ●
- 27 DALIBAS2 ●
- 28 DALIBAS3
- 29 IRONBASS ●
- 30 SEAMNSTR ●
- 31 D&BFRAG1
- 32 POPPX
- 33 WINER ●
- 34 DOOMED ●
- 35 ANVILISH
- 36 TRANQUL ●
- 37 MOSHER ●
- 38 D&BFRAG8
- 39 PEEPER
- 40 WYZOG
- 41 D&FRAG11
- 42 SCRUNCH
- 43 VOLTAGE ●
- 44 D&FRAG14
- 45 GRONKER
- 46 SEMILOOP
- 47 POINGER
- 48 JNGSN11 ●
- 49 SUKRPNCH
- 50 D&FRAG20
- 51 BOUNGER ●
- 52 SHUTDOWN ●
- 53 DOPPLER ●
- 54 DUCKSTER ●
- 55 TAMTAMY ●
- 56 PANKY ●
- 57 ANAFROGR ●
- 58 GOWAH ●
- 59 DEEPDIVE ●
- 60 ASCENDER

- 61 JURASSIC ●
- 62 CLOUDS ●
- 63 TRAINBRK ●
- 64 RUNNER ●
- 65 RADAMACU ●
- 66 UMK 47
- 67 FRAG23
- 68 AmbHit10
- 69 WAKX PAD
- 70 AmbHit01
- 71 QueSPACE
- 72 AmbHit02
- 73 FRAG13
- 74 Vocal04 ●
- 75 FRAG03
- 76 FRAG14
- 77 FRAG12
- 78 FRAG08
- 79 FRAG01
- 80 FRAG18
- 81 FRAG11
- 82 FRAG05
- 83 FRAG21
- 84 FRAG20

L : Drum Loop

- 1 DigiTime ●
- 2 Hollis L
- 3 KillnL
- 4 LITELOOP
- 5 LoMLoop ●
- 6 MachineL ●
- 7 NYCLoop ●
- 8 PsychoLP ●
- 9 SNAPLOOP
- 10 AlienSp ●
- 11 Cymbloop ●
- 12 DIGERDO
- 13 Spirals
- 14 SwingnL
- 15 UptownL
- 16 WE LOOP
- 17 E NZE
- 18 ET Loop ●
- 19 EvlLoop
- 20 FactryLP
- 21 HellsBel
- 22 LoMO LP
- 23 LoMsolo
- 24 LPscNoiz
- 25 HeliLoop
- 26 StreamLP

m : misc. voices

- 1 Brass 4
- 2 Brass 5
- 3 Celesta
- 4 Chor 516
- 5 Chor 539
- 6 Chorus 4
- 7 GlockenH

- 8 GlockenL
- 9 GlockenM
- 10 Marimba
- 11 MTrp 4
- 12 ORGAN 3
- 13 SBrass 4
- 14 SBrass 5
- 15 sitar599
- 16 SteelDr3
- 17 SynPf 3
- 18 Trb 3
- 19 Trp 4
- 20 vibe 541
- 21 Xylophon
- 22 SStrngA4
- 23 SStrngB4
- 24 STRNG 3
- 25 STRNG 4
- 26 Syn 3
- 27 SynSt 3
- 28 AcBass
- 29 BassSAWH
- 30 BassSAWL
- 31 BassSINH
- 32 BassSINL
- 33 SyBass2H
- 34 SyBass2L

GM Keyboard Voice List

● : 2-layer voice

No.	Category	Name	No.	Category	Name	No.	Category	Name	No.	Category	Name
1	Piano	GrandPno	33	Bass	Aco.Bass	65	Reed	SprnoSax	97	Synth Effects	Rain ●
2		BritePno	34		FngrBass	66		Alto Sax	98		SoundTrk ●
3		E.Grand ●	35		PickBass	67		TenorSax	99		Crystal ●
4		HnkyTonk ●	36		Fretless	68		Bari.Sax	100		Atmosphr ●
5		E.Piano1 ●	37		SlapBas1	69		Oboe	101		Bright ●
6		E.Piano2 ●	38		SlapBas2	70		Eng.Horn	102		Goblins ●
7		Harpsi.	39		SynBass1	71		Bassoon	103		Echoes ●
8		Clavi.	40		SynBass2	72		Clarinet	104		SF ●
9	Chromatic Percussion	Celesta	41	Strings	Violin	73	Pipe	Piccolo	105	Ethnic	Sitar
10		Glocken	42		Viola	74		Flute	106		Banjo
11		MusicBox ●	43		Cello	75		Recorder	107		Shamisen
12		Vibes	44		ContraBs	76		PanFlute	108		Koto
13		Marimba	45		Trem.Str ●	77		Bottle ●	109		Kalimba
14		Xylophon	46		Pizz.Str ●	78		Shakhchi	110		Bagpipe ●
15		TubulBel	47		Harp	79		Whistle	111		Fiddle
16		Dulcimer ●	48		Timpani	80		Ocalina	112		Shanai
17	Organ	DrawOrgn	49	Ensemble	Strings1	81	Synth Lead	SquareLd ●	113	Percussive	TnklBell ●
18		PercOrgn	50		Strings2	82		Saw.Lead ●	114		Agogo
19		RockOrgn ●	51		Syn.Str1 ●	83		CaliopLd ●	115		SteelDrm ●
20		ChrchOrg ●	52		Syn.Str2 ●	84		Chiff Ld ●	116		WoodBlok
21		ReedOrgn	53		ChoirAah ●	85		CharanLd ●	117		TaikoDrm
22		Acordion ●	54		VoiceOoh	86		Voice Ld ●	118		MelodTom
23		Harmnica	55		SynVoice	87		Fifth Ld ●	119		Syn.Drum
24		TangoAcid ●	56		Orch.Hit	88		Bass &Ld ●	120		RevCymbL
25	Guitar	NylonGtr	57	Brass	Trumpet	89	Synth Pad	NewAgePd ●	121	Sound Effect	FretNoiz
26		SteelGtr	58		Trombone	90		Warm Pad ●	122		BrthNoiz
27		Jazz Gtr	59		Tuba	91		PolySyPd ●	123		Seashore ●
28		CleanGtr ●	60		Mute.Trp	92		ChoirPad ●	124		Tweet ●
29		Mute.Gtr	61		Fr.Horn	93		BowedPad ●	125		Telephone
30		Ovrdrive	62		BrasSect	94		MetalPad ●	126		Helicptr ●
31		Dist.Gtr	63		SynBras1 ●	95		Halo Pad ●	127		Applause ●
32		GtrHarmo	64		SynBras2 ●	96		SweepPad ●	128		Gunshot

Preset Drum Kit List

● : Kits used with the pad songs

No.	Name	No.	Name	No.	Name	No.	Name
1	Acoustic	13	(In)	25	World	37	MondoKit ●
2	NewBeat	14	In&Out	26	Reggae	38	Torqkit ●
3	Rock kit	15	HipFunky	27	Tabla	39	Mystery ●
4	RockDry1	16	Dance 1	28	Cocktail	40	GM std 1
5	RockDry2	17	Dance 2	29	JamKit99	41	GM std 2
6	RockDry3	18	SoDance	30	GoezOn!?	42	GM room
7	RockDry4	19	Manh	31	InDaHood	43	GM rock
8	BigRevrB	20	D@RK	32	GroovKit ●	44	GM elec.
9	Ballade	21	Oh!No!	33	Bs.@Base ●	45	GM anal.
10	BeBop	22	Latin/Tm	34	JungleNY	46	GM jazz
11	Andora	23	LatinPer	35	Snapkit	47	GM brush
12	Room Kit	24	Zebulon	36	JumpBack ●	48	GM class

No. 1 Acoustic

Input Source	Voice-1 Cat./No./Name	Voice-2 Cat./No./Name
pad1	K 17 BDaffty1	K 0 NoAssign
rim1	K 0 NoAssign	K 0 NoAssign
pad2	S 1 Loosy	K 0 NoAssign
rim2	S 79 OpnRim	K 0 NoAssign
pad3	T 1 Dry1 Hi	K 0 NoAssign
rim3	T 71 ACTomH	K 0 NoAssign
pad4	T 2 Dry1 Mid	K 0 NoAssign
rim4	T 72 ACTomM	K 0 NoAssign
pad5	T 3 Dry1 Lo	K 0 NoAssign
rim5	T 73 ACTomL	K 0 NoAssign
pad6	C 28 SizzlDrk	K 0 NoAssign
rim6	C 24 RidesizB	K 0 NoAssign
pad7	C 1 CrashB	K 0 NoAssign
rim7	C 37 China	K 0 NoAssign
open	H 23 H OpnL2	K 0 NoAssign
rimOpen	H 25 H OpnLK	K 0 NoAssign
close	H 23 H OpnL2	K 0 NoAssign
rimClose	H 23 H OpnL2	K 0 NoAssign
footClose	H 32 H PdlDW	K 0 NoAssign
splash	H 48 Hpsplsh1	K 0 NoAssign
pad9	C 33 Bell A	K 0 NoAssign
pad10	P 33 CowB1	K 0 NoAssign

No. 2 NewBeat

Input Source	Voice-1 Cat./No./Name	Voice-2 Cat./No./Name
pad1	K 43 BD Metal	K 0 NoAssign
rim1	K 0 NoAssign	K 0 NoAssign
pad2	S 46 RIMetal	K 0 NoAssign
rim2	S 33 12Soprno	K 0 NoAssign
pad3	T 58 Rock 5	K 0 NoAssign
rim3	T 6 DRY GM5	K 0 NoAssign
pad4	T 60 Rock 3	K 0 NoAssign
rim4	T 8 DRY GM3	K 0 NoAssign
pad5	T 61 Rock 2	K 0 NoAssign
rim5	T 10 DRY GM1	K 0 NoAssign
pad6	C 16 RideDark	K 0 NoAssign
rim6	C 20 Rider3	K 0 NoAssign
pad7	C 1 CrashB	K 0 NoAssign
rim7	C 2 BriteCrs	K 0 NoAssign
open	H 26 H OpnLX1	K 0 NoAssign
rimOpen	H 26 H OpnLX1	K 0 NoAssign
close	H 1 H Cls01	K 0 NoAssign
rimClose	H 34 H PdlMu	K 0 NoAssign
footClose	H 38 Hpdclcs1	K 0 NoAssign
splash	H 48 Hpsplsh1	K 0 NoAssign
pad9	C 33 Bell A	K 0 NoAssign
pad10	P 33 CowB1	K 0 NoAssign

No. 3 Rock kit

Input Source	Voice-1 Cat./No./Name	Voice-2 Cat./No./Name
pad1	K 34 BDbasc2	K 32 2HeadLo
rim1	P 34 CowB2	K 0 NoAssign
pad2	s 87 Sheetmtl	S 1 Loosy
rim2	S 96 Fatbrim	K 0 NoAssign
pad3	T 75 Room1 Hi	K 0 NoAssign
rim3	T 83 Night H	K 0 NoAssign
pad4	T 76 Room1Mid	K 0 NoAssign
rim4	T 84 Night M	K 0 NoAssign
pad5	T 77 Room1 Lo	K 0 NoAssign
rim5	T 85 Night L	K 0 NoAssign
pad6	C 31 SizzlRck	K 0 NoAssign
rim6	C 36 RidB Rc	K 0 NoAssign
pad7	C 37 China	K 0 NoAssign
rim7	C 1 CrashB	K 0 NoAssign

open	H 29 HHRoKopn	K 0 NoAssign
rimOpen	H 29 HHRoKopn	K 0 NoAssign
close	H 6 H ClsNB1	K 0 NoAssign
rimClose	H 5 H ClsMu	K 0 NoAssign
footClose	H 37 HHFTpd1	K 0 NoAssign
splash	H 44 FTsplsh1	K 0 NoAssign
pad9	C 32 RidB Lit	K 0 NoAssign
pad10	P 33 CowB1	K 0 NoAssign

No. 4 RockDry1

Input Source	Voice-1 Cat./No./Name	Voice-2 Cat./No./Name
pad1	K 41 BD GATE2	K 35 BD KONG1
rim1	K 0 NoAssign	K 0 NoAssign
pad2	S 97 Brass55	K 0 NoAssign
rim2	S 96 Fatbrim	K 0 NoAssign
pad3	T 58 Rock 5	K 0 NoAssign
rim3	T 83 Night H	K 0 NoAssign
pad4	T 59 Rock 4	K 0 NoAssign
rim4	T 84 Night M	K 0 NoAssign
pad5	T 60 Rock 3	K 0 NoAssign
rim5	T 85 Night L	K 0 NoAssign
pad6	C 22 RideRock	K 0 NoAssign
rim6	C 37 China	K 0 NoAssign
pad7	C 41 C Splsh1	K 0 NoAssign
rim7	C 3 C Crash	K 0 NoAssign
open	H 43 FTsprk2	K 0 NoAssign
rimOpen	H 29 HHRoKopn	K 0 NoAssign
close	H 2 H Cls13	K 0 NoAssign
rimClose	H 29 HHRoKopn	K 0 NoAssign
footClose	H 37 HHFTpd1	K 0 NoAssign
splash	H 48 Hpsplsh1	K 0 NoAssign
pad9	C 35 RidB Drk	K 0 NoAssign
pad10	P 33 CowB1	K 0 NoAssign

No. 5 RockDry2

Input Source	Voice-1 Cat./No./Name	Voice-2 Cat./No./Name
pad1	K 32 2HeadLo	K 11 BD NN04C
rim1	K 0 NoAssign	K 0 NoAssign
pad2	S 63 SnareM	K 0 NoAssign
rim2	S 47 RIMntrl	K 0 NoAssign
pad3	T 1 Dry1 Hi	K 0 NoAssign
rim3	T 83 Night H	K 0 NoAssign
pad4	T 2 Dry1 Mid	K 0 NoAssign
rim4	T 84 Night M	K 0 NoAssign
pad5	T 3 Dry1 Lo	K 0 NoAssign
rim5	T 85 Night L	K 0 NoAssign
pad6	C 16 RideDark	K 0 NoAssign
rim6	C 24 RidesizB	K 0 NoAssign
pad7	C 37 China	K 0 NoAssign
rim7	C 1 CrashB	K 0 NoAssign
open	H 26 H OpnLX1	K 0 NoAssign
rimOpen	H 23 H OpnL2	K 0 NoAssign
close	H 6 H ClsNB1	K 0 NoAssign
rimClose	H 23 H OpnL2	K 0 NoAssign
footClose	H 35 H PdlNB	K 0 NoAssign
splash	H 46 H SplNB	K 0 NoAssign
pad9	C 33 Bell A	K 0 NoAssign
pad10	P 33 CowB1	K 0 NoAssign

No. 6 RockDry3

Input Source	Voice-1 Cat./No./Name	Voice-2 Cat./No./Name
pad1	K 39 BDbonz02	K 19 MapleA20
rim1	K 0 NoAssign	K 0 NoAssign
pad2	S 60 Fat looz	K 0 NoAssign
rim2	s 19 Elektrik	K 0 NoAssign
pad3	T 75 Room1 Hi	K 0 NoAssign

rim3	T 71 ACTomH	K 0 NoAssign
pad4	T 76 Room1Mid	K 0 NoAssign
rim4	T 72 ACTomM	K 0 NoAssign
pad5	T 77 Room1 Lo	K 0 NoAssign
rim5	T 73 ACTomL	K 0 NoAssign
pad6	C 16 RideDark	K 0 NoAssign
rim6	C 24 RidesizB	K 0 NoAssign
pad7	C 39 MinChina	K 0 NoAssign
rim7	C 5 CrshDRK	K 0 NoAssign
open	H 26 H OpnLX1	K 0 NoAssign
rimOpen	H 23 H OpnL2	K 0 NoAssign
close	H 6 H ClsNB1	K 0 NoAssign
rimClose	H 23 H OpnL2	K 0 NoAssign
footClose	H 32 H PdlDW	K 0 NoAssign
splash	H 46 H SplNB	K 0 NoAssign
pad9	C 33 Bell A	K 0 NoAssign
pad10	P 33 CowB1	K 0 NoAssign

No. 7 RockDry4

Input Source	Voice-1 Cat./No./Name	Voice-2 Cat./No./Name
pad1	K 49 BDevolvr	K 3 Basic
rim1	K 0 NoAssign	K 0 NoAssign
pad2	S 91 OpnRimC	K 0 NoAssign
rim2	S 105GhiGateSn	K 0 NoAssign
pad3	T 35 Dry2 Hi	K 0 NoAssign
rim3	T 71 ACTomH	K 0 NoAssign
pad4	T 36 Dry2 Mid	K 0 NoAssign
rim4	T 72 ACTomM	K 0 NoAssign
pad5	T 37 Dry2 Lo	K 0 NoAssign
rim5	T 73 ACTomL	K 0 NoAssign
pad6	C 16 RideDark	K 0 NoAssign
rim6	C 24 RidesizB	K 0 NoAssign
pad7	C 39 MinChina	K 0 NoAssign
rim7	C 5 CrshDRK	K 0 NoAssign
open	H 26 H OpnLX1	K 0 NoAssign
rimOpen	H 23 H OpnL2	K 0 NoAssign
close	H 6 H ClsNB1	K 0 NoAssign
rimClose	H 23 H OpnL2	K 0 NoAssign
footClose	H 32 H PdlDW	K 0 NoAssign
splash	H 46 H SplNB	K 0 NoAssign
pad9	C 33 Bell A	K 0 NoAssign
pad10	P 33 CowB1	K 0 NoAssign

No. 8 BigRevrB

Input Source	Voice-1 Cat./No./Name	Voice-2 Cat./No./Name
pad1	K 2 2HedMed2	K 1 2HedMed1
rim1	K 0 NoAssign	K 0 NoAssign
pad2	S 23 Wood Sn	K 0 NoAssign
rim2	S 23 Wood Sn	K 0 NoAssign
pad3	T 6 DRY GM5	K 0 NoAssign
rim3	P 57 Shake2	K 0 NoAssign
pad4	T 7 DRY GM4	K 0 NoAssign
rim4	P 76 Tamba	K 0 NoAssign
pad5	T 9 DRY GM2	K 0 NoAssign
rim5	P 97 WoodBloc	K 0 NoAssign
pad6	C 23 RidesizA	K 0 NoAssign
rim6	C 19 RideLite	K 0 NoAssign
pad7	C 3 C Crash	K 0 NoAssign
rim7	C 6 DeepDRK	K 0 NoAssign
open	H 26 H OpnLX1	K 0 NoAssign
rimOpen	H 26 H OpnLX1	K 0 NoAssign
close	H 6 H ClsNB1	K 0 NoAssign
rimClose	H 34 H PdlMu	K 0 NoAssign
footClose	H 38 Hpdclcs1	K 0 NoAssign
splash	H 47 H Splst	K 0 NoAssign
pad9	C 34 BellTip	K 0 NoAssign
pad10	P 34 CowB2	K 0 NoAssign

Preset Drum Kit List

No. 9 Ballade

Input Source	Voice-1 Cat./No./Name	Voice-2 Cat./No./Name	
pad1	K 11 BD NN04C	K 0	NoAssign
rim1	K 0 NoAssign	K 0	NoAssign
pad2	S 110 S SStck2	K 0	NoAssign
rim2	S 15 OldCan	K 0	NoAssign
pad3	T 1 Dry1 Hi	K 0	NoAssign
rim3	T 6 DRY GM5	K 0	NoAssign
pad4	T 2 Dry1 Mid	K 0	NoAssign
rim4	T 8 DRY GM3	K 0	NoAssign
pad5	T 3 Dry1 Lo	K 0	NoAssign
rim5	T 10 DRY GM1	K 0	NoAssign
pad6	C 19 RideLite	K 0	NoAssign
rim6	C 20 Rider3	K 0	NoAssign
pad7	C 1 CrashB	K 0	NoAssign
rim7	C 2 BriteCrs	K 0	NoAssign
open	H 26 H OpnLX1	K 0	NoAssign
rimOpen	H 26 H OpnLX1	K 0	NoAssign
close	H 26 H OpnLX1	K 0	NoAssign
rimClose	H 34 H PdIMu	K 0	NoAssign
footClose	H 38 Hpdclis1	K 0	NoAssign
splash	H 48 Hpsplsh1	K 0	NoAssign
pad9	C 33 Bell A	K 0	NoAssign
pad10	P 33 CowB1	K 0	NoAssign

No. 10 BeBop

Input Source	Voice-1 Cat./No./Name	Voice-2 Cat./No./Name	
pad1	K 36 BDersko1	K 0	NoAssign
rim1	K 0 NoAssign	K 0	NoAssign
pad2	S 78 Cool Dry	S 17 LiteSnr1	
rim2	S 79 OpnRim	K 0	NoAssign
pad3	T 19 Jazz Hi	K 0	NoAssign
rim3	T 24 BrshJzMd	K 0	NoAssign
pad4	T 20 Jazz Mid	K 0	NoAssign
rim4	T 26 BrshJzFI	K 0	NoAssign
pad5	T 22 Jazz Flr	K 0	NoAssign
rim5	s 100 BrshAtak	K 0	NoAssign
pad6	C 23 RidesizA	K 0	NoAssign
rim6	C 24 RidesizB	K 0	NoAssign
pad7	C 38 ChinaHi	K 0	NoAssign
rim7	C 7 FasCrash	K 0	NoAssign
open	H 20 H OpnDW	K 0	NoAssign
rimOpen	H 21 H OpnDWX	K 0	NoAssign
close	H 20 H OpnDW	K 0	NoAssign
rimClose	H 21 H OpnDWX	K 0	NoAssign
footClose	H 31 H PdI13	K 0	NoAssign
splash	H 48 Hpsplsh1	K 0	NoAssign
pad9	C 35 RidB Drk	K 0	NoAssign
pad10	P 33 CowB1	K 0	NoAssign

No. 11 Andora

Input Source	Voice-1 Cat./No./Name	Voice-2 Cat./No./Name	
pad1	K 19 MapleA20	K 36 BDersko1	
rim1	P 33 CowB1	K 0	NoAssign
pad2	S 17 LiteSnr1	K 0	NoAssign
rim2	S 79 OpnRim	K 0	NoAssign
pad3	T 11 Maple10	K 0	NoAssign
rim3	T 1 Dry1 Hi	K 0	NoAssign
pad4	T 13 Maple14	K 0	NoAssign
rim4	T 2 Dry1 Mid	K 0	NoAssign
pad5	T 14 Maple16	K 0	NoAssign
rim5	T 4 Dry1 Flr	K 0	NoAssign
pad6	C 16 RideDark	K 0	NoAssign
rim6	C 21 RideRock	K 0	NoAssign
pad7	C 1 CrashB	K 0	NoAssign
rim7	C 37 China	K 0	NoAssign

open	H 23 H OpnL2	K 0	NoAssign
rimOpen	H 25 H OpnLK	K 0	NoAssign
close	H 23 H OpnL2	K 0	NoAssign
rimClose	H 23 H OpnL2	K 0	NoAssign
footClose	H 32 H PdIDW	K 0	NoAssign
splash	H 48 Hpsplsh1	K 0	NoAssign
pad9	C 32 RidB Lit	K 0	NoAssign
pad10	P 33 CowB1	K 0	NoAssign

No. 12 Room Kit

Input Source	Voice-1 Cat./No./Name	Voice-2 Cat./No./Name	
pad1	K 19 MapleA20	K 0	NoAssign
rim1	K 0 NoAssign	K 0	NoAssign
pad2	S 85 ParadeS	K 0	NoAssign
rim2	S 79 OpnRim	K 0	NoAssign
pad3	T 75 Room1 Hi	K 0	NoAssign
rim3	T 71 ACTomH	K 0	NoAssign
pad4	T 76 Room1Mid	K 0	NoAssign
rim4	T 72 ACTomM	K 0	NoAssign
pad5	T 78 Room1Flr	K 0	NoAssign
rim5	T 73 ACTomL	K 0	NoAssign
pad6	C 28 SizzlDrk	K 0	NoAssign
rim6	C 24 RidesizB	K 0	NoAssign
pad7	C 1 CrashB	K 0	NoAssign
rim7	C 37 China	K 0	NoAssign
open	H 23 H OpnL2	K 0	NoAssign
rimOpen	H 25 H OpnLK	K 0	NoAssign
close	H 23 H OpnL2	K 0	NoAssign
rimClose	H 23 H OpnL2	K 0	NoAssign
footClose	H 32 H PdIDW	K 0	NoAssign
splash	H 48 Hpsplsh1	K 0	NoAssign
pad9	C 33 Bell A	K 0	NoAssign
pad10	P 33 CowB1	K 0	NoAssign

No. 13 (In)

Input Source	Voice-1 Cat./No./Name	Voice-2 Cat./No./Name	
pad1	K 11 BD NN04C	K 0	NoAssign
rim1	K 0 NoAssign	K 0	NoAssign
pad2	S 37 Beauty	K 0	NoAssign
rim2	S 36 BeatyRim	K 0	NoAssign
pad3	T 31 TOMntrIH	K 0	NoAssign
rim3	K 0 NoAssign	K 0	NoAssign
pad4	T 32 TOMntrIM	K 0	NoAssign
rim4	K 0 NoAssign	K 0	NoAssign
pad5	T 33 TOMntrIL	K 0	NoAssign
rim5	K 0 NoAssign	K 0	NoAssign
pad6	C 17 Ridedrk	K 0	NoAssign
rim6	C 19 RideLite	K 0	NoAssign
pad7	C 6 DeepDRK	K 0	NoAssign
rim7	C 41 C Splsh1	K 0	NoAssign
open	H 26 H OpnLX1	K 0	NoAssign
rimOpen	H 26 H OpnLX1	K 0	NoAssign
close	H 11 H TICls1	K 0	NoAssign
rimClose	H 34 H PdIMu	K 0	NoAssign
footClose	H 38 Hpdclis1	K 0	NoAssign
splash	H 48 Hpsplsh1	K 0	NoAssign
pad9	C 33 Bell A	K 0	NoAssign
pad10	P 34 CowB2	K 0	NoAssign

No. 14 In&Out

Input Source	Voice-1 Cat./No./Name	Voice-2 Cat./No./Name	
pad1	k 1 AnaQuick	K 0	NoAssign
rim1	K 0 NoAssign	K 0	NoAssign
pad2	s 82 S Gate3	K 0	NoAssign
rim2	s 31 RlMpoopr	K 0	NoAssign
pad3	e 43 VOLTAGE	K 0	NoAssign

rim3	T 1 Dry1 Hi	K 0	NoAssign
pad4	e 50 D&FRAG20	K 0	NoAssign
rim4	T 1 Dry1 Hi	K 0	NoAssign
pad5	e 33 WINER	K 0	NoAssign
rim5	T 1 Dry1 Hi	K 0	NoAssign
pad6	L 1 DigiTime	K 0	NoAssign
rim6	C 19 RideLite	K 0	NoAssign
pad7	E 11 C Crash	K 0	NoAssign
rim7	C 41 C Splsh1	K 0	NoAssign
open	P 31 CongBe	K 0	NoAssign
rimOpen	H 26 H OpnLX1	K 0	NoAssign
close	P 11 Bongo Hi	K 0	NoAssign
rimClose	H 34 H PdIMu	K 0	NoAssign
footClose	P 39 EthWB	K 0	NoAssign
splash	H 48 Hpsplsh1	K 0	NoAssign
pad9	C 33 Bell A	K 0	NoAssign
pad10	P 34 CowB2	K 0	NoAssign

No. 15 HipFunky

Input Source	Voice-1 Cat./No./Name	Voice-2 Cat./No./Name	
pad1	K 8 BD GMH	K 0	NoAssign
rim1	K 0 NoAssign	K 0	NoAssign
pad2	S 14 Hip Hop	K 0	NoAssign
rim2	S 33 12Soprno	K 0	NoAssign
pad3	T 36 Dry2 Mid	K 0	NoAssign
rim3	P 6 AnMaracs	K 0	NoAssign
pad4	T 37 Dry2 Lo	K 0	NoAssign
rim4	P 12 Bongo Lo	K 0	NoAssign
pad5	T 38 Dry2 Flr	K 0	NoAssign
rim5	P 30 CongaS	K 0	NoAssign
pad6	C 23 RidesizA	K 0	NoAssign
rim6	C 16 RideDark	K 0	NoAssign
pad7	C 9 PaperThn	K 0	NoAssign
rim7	C 3 C Crash	K 0	NoAssign
open	H 26 H OpnLX1	K 0	NoAssign
rimOpen	H 26 H OpnLX1	K 0	NoAssign
close	H 1 H CIs01	K 0	NoAssign
rimClose	H 18 H OPMu	K 0	NoAssign
footClose	H 38 Hpdclis1	K 0	NoAssign
splash	H 48 Hpsplsh1	K 0	NoAssign
pad9	C 36 RidB Rc	K 0	NoAssign
pad10	P 34 CowB2	K 0	NoAssign

No. 16 Dance 1

Input Source	Voice-1 Cat./No./Name	Voice-2 Cat./No./Name	
pad1	k 7 BDDance2	K 0	NoAssign
rim1	P 35 CowBAn	K 0	NoAssign
pad2	s 95 Tekk3	K 0	NoAssign
rim2	s 30 HiFive	K 0	NoAssign
pad3	t 21 TEKK 2L	K 0	NoAssign
rim3	P 6 AnMaracs	K 0	NoAssign
pad4	t 23 TEKK 3H	K 0	NoAssign
rim4	P 55 Scrach	K 0	NoAssign
pad5	t 24 TEKK 3M	K 0	NoAssign
rim5	P 55 Scrach	K 0	NoAssign
pad6	C 45 Ride Anl	K 0	NoAssign
rim6	C 32 RidB Lit	K 0	NoAssign
pad7	C 44 AngCym	K 0	NoAssign
rim7	C 41 C Splsh1	K 0	NoAssign
open	H 50 H OpnAn	K 0	NoAssign
rimOpen	P 78 Tambourn	K 0	NoAssign
close	H 3 H CIsA1	K 0	NoAssign
rimClose	H 5 H CIsMu	K 0	NoAssign
footClose	H 4 H CIsA2	K 0	NoAssign
splash	H 48 Hpsplsh1	K 0	NoAssign
pad9	C 32 RidB Lit	K 0	NoAssign
pad10	P 33 CowB1	K 0	NoAssign

No. 17 Dance2

Input Source	Voice-1 Cat./No./Name	Voice-2 Cat./No./Name
pad1	k 12 BDDance9	K 0 NoAssign
rim1	s 12 AnSStick	K 0 NoAssign
pad2	s 17 Dance05	K 0 NoAssign
rim2	s 19 Elektrik	K 0 NoAssign
pad3	t 41 ElectorH	K 0 NoAssign
rim3	P 56 Shake1	K 0 NoAssign
pad4	t 42 ElectorM	K 0 NoAssign
rim4	P 52 Maracas3	K 0 NoAssign
pad5	t 43 ElectorL	K 0 NoAssign
rim5	P 55 Scrach	K 0 NoAssign
pad6	C 45 Ride Anl	K 0 NoAssign
rim6	C 32 RidB Lit	K 0 NoAssign
pad7	C 44 AngCym	K 0 NoAssign
rim7	C 42 C Splsh2	K 0 NoAssign
open	H 50 H OpnAn	K 0 NoAssign
rimOpen	P 78 Tambourn	K 0 NoAssign
close	H 3 H ClsA1	K 0 NoAssign
rimClose	H 5 H ClsMu	K 0 NoAssign
footClose	H 4 H ClsA2	K 0 NoAssign
splash	H 48 Hpsplsh1	K 0 NoAssign
pad9	C 32 RidB Lit	K 0 NoAssign
pad10	P 33 CowB1	K 0 NoAssign

No. 18 SoDance

Input Source	Voice-1 Cat./No./Name	Voice-2 Cat./No./Name
pad1	k 13 BDlong1	K 19 MapleA20
rim1	K 0 NoAssign	K 0 NoAssign
pad2	s 4 Analog H	K 0 NoAssign
rim2	s 19 Elektrik	K 0 NoAssign
pad3	E 15 CoolSA	K 0 NoAssign
rim3	T 71 ACTomH	K 0 NoAssign
pad4	E 15 CoolSA	K 0 NoAssign
rim4	T 72 ACTomM	K 0 NoAssign
pad5	E 83 USS	t 44 ElectrCF
rim5	T 73 ACTomL	K 0 NoAssign
pad6	C 18 Ride'EM	K 0 NoAssign
rim6	C 13 C FX02	K 0 NoAssign
pad7	E 2 Ambush	K 0 NoAssign
rim7	C 47 HCym2	K 0 NoAssign
open	H 49 H OpnAMu	K 0 NoAssign
rimOpen	H 50 H OpnAn	K 0 NoAssign
close	H 12 H TiClis2	K 0 NoAssign
rimClose	H 51 H OpnLA1	K 0 NoAssign
footClose	t 51 ETMooRL	K 0 NoAssign
splash	H 46 H SplNB	K 0 NoAssign
pad9	P 35 CowBAn	K 0 NoAssign
pad10	P 33 CowB1	K 0 NoAssign

No. 19 Manh

Input Source	Voice-1 Cat./No./Name	Voice-2 Cat./No./Name
pad1	K 6 BD DRY 3	e 39 PEEPER
rim1	K 0 NoAssign	K 0 NoAssign
pad2	S 1 Loosy	K 0 NoAssign
rim2	S 1 Loosy	K 0 NoAssign
pad3	E 36 HipNs	K 0 NoAssign
rim3	T 6 DRY GM5	K 0 NoAssign
pad4	e 64 RUNNER	K 0 NoAssign
rim4	T 8 DRY GM3	K 0 NoAssign
pad5	e 74 Vocal04	K 0 NoAssign
rim5	T 10 DRY GM1	K 0 NoAssign
pad6	C 45 Ride Anl	K 0 NoAssign
rim6	C 20 Rider3	K 0 NoAssign
pad7	C 44 AngCym	K 0 NoAssign
rim7	C 43 C FX01	K 0 NoAssign

open	H 26 H OpnLX1	K 0 NoAssign
rimOpen	H 26 H OpnLX1	K 0 NoAssign
close	H 1 H Cls01	K 0 NoAssign
rimClose	H 34 H PdlMu	K 0 NoAssign
footClose	H 38 Hpdclsl1	K 0 NoAssign
splash	H 48 Hpsplsh1	K 0 NoAssign
pad9	C 33 Bell A	K 0 NoAssign
pad10	P 33 CowB1	K 0 NoAssign

No. 20 D@RK

Input Source	Voice-1 Cat./No./Name	Voice-2 Cat./No./Name
pad1	k 12 BDDance9	k 17 Sub2
rim1	K 0 NoAssign	K 0 NoAssign
pad2	s 7 AnalogL1	K 0 NoAssign
rim2	s 43 AnaWee	K 0 NoAssign
pad3	t 24 TEKK 3M	K 0 NoAssign
rim3	T 6 DRY GM5	K 0 NoAssign
pad4	t 25 TEKK 3L	K 0 NoAssign
rim4	T 8 DRY GM3	K 0 NoAssign
pad5	e 64 RUNNER	K 0 NoAssign
rim5	T 10 DRY GM1	K 0 NoAssign
pad6	C 45 Ride Anl	K 0 NoAssign
rim6	C 20 Rider3	K 0 NoAssign
pad7	C 1 CrashB	K 0 NoAssign
rim7	C 2 BriteCrs	K 0 NoAssign
open	H 50 H OpnAn	K 0 NoAssign
rimOpen	H 26 H OpnLX1	K 0 NoAssign
close	H 50 H OpnAn	K 0 NoAssign
rimClose	H 34 H PdlMu	K 0 NoAssign
footClose	H 50 H OpnAn	K 0 NoAssign
splash	H 49 H OpnAMu	K 0 NoAssign
pad9	C 33 Bell A	K 0 NoAssign
pad10	P 33 CowB1	K 0 NoAssign

No. 21 Oh!No!

Input Source	Voice-1 Cat./No./Name	Voice-2 Cat./No./Name
pad1	k 6 BDDance1	K 0 NoAssign
rim1	K 0 NoAssign	K 0 NoAssign
pad2	s 57 Eno rim	K 0 NoAssign
rim2	s 58 Enotype	K 0 NoAssign
pad3	E 58 OrcHt1	K 0 NoAssign
rim3	T 6 DRY GM5	K 0 NoAssign
pad4	E 58 OrcHt1	K 0 NoAssign
rim4	T 8 DRY GM3	K 0 NoAssign
pad5	L 14 SwingnL	L 20 FactryLP
rim5	T 10 DRY GM1	K 0 NoAssign
pad6	E 58 OrcHt1	K 0 NoAssign
rim6	C 20 Rider3	K 0 NoAssign
pad7	C 13 C FX02	C 10 ReverseC
rim7	C 13 C FX02	K 0 NoAssign
open	E 57 OrchSmsh	K 0 NoAssign
rimOpen	H 26 H OpnLX1	K 0 NoAssign
close	E 10 BuzzyWak	K 0 NoAssign
rimClose	E 10 BuzzyWak	K 0 NoAssign
footClose	P 59 SIBell	K 0 NoAssign
splash	C 48 HCymClsl	K 0 NoAssign
pad9	P 55 Scrach	K 0 NoAssign
pad10	P 45 HiQ	K 0 NoAssign

No. 22 Latin/Tm

Input Source	Voice-1 Cat./No./Name	Voice-2 Cat./No./Name
pad1	K 29 BD ROOM5	K 0 NoAssign
rim1	K 0 NoAssign	K 0 NoAssign
pad2	S 31 MickCJ8S	K 0 NoAssign
rim2	S 120Latinrim	K 0 NoAssign
pad3	P 81 TimbH	K 0 NoAssign

rim3	P 27 CongaMV	K 0 NoAssign
pad4	P 82 TimbL	K 0 NoAssign
rim4	P 80 Timb	K 0 NoAssign
pad5	P 29 CongaO	K 0 NoAssign
rim5	P 51 Maracas2	K 0 NoAssign
pad6	C 19 RideLite	K 0 NoAssign
rim6	C 20 Rider3	K 0 NoAssign
pad7	C 1 CrashB	K 0 NoAssign
rim7	C 2 BriteCrs	K 0 NoAssign
open	P 2 AgogoH1	K 0 NoAssign
rimOpen	H 26 H OpnLX1	K 0 NoAssign
close	P 1 XfadeTri	K 0 NoAssign
rimClose	H 34 H PdlMu	K 0 NoAssign
footClose	P 33 CowB1	K 0 NoAssign
splash	H 1 H Cls01	K 0 NoAssign
pad9	C 33 Bell A	K 0 NoAssign
pad10	P 34 CowB2	K 0 NoAssign

No. 23 LatinPer

Input Source	Voice-1 Cat./No./Name	Voice-2 Cat./No./Name
pad1	K 1 2HedMed1	K 0 NoAssign
rim1	P 12 Bongo Lo	K 0 NoAssign
pad2	P 21 Conga	K 0 NoAssign
rim2	P 25 CongaH	K 0 NoAssign
pad3	P 81 TimbH	K 0 NoAssign
rim3	P 33 CowB1	K 0 NoAssign
pad4	P 82 TimbL	K 0 NoAssign
rim4	P 83 TimCas	K 0 NoAssign
pad5	P 89 Udo H	K 0 NoAssign
rim5	P 70 TablaO	K 0 NoAssign
pad6	P 3 AgogoH2	K 0 NoAssign
rim6	P 3 AgogoH2	K 0 NoAssign
pad7	P 38 Cuical	K 0 NoAssign
rim7	C 3 C Crash	K 0 NoAssign
open	P 21 Conga	K 0 NoAssign
rimOpen	P 26 CongaM	K 0 NoAssign
close	P 49 Log L	K 0 NoAssign
rimClose	P 19 Clvs	K 0 NoAssign
footClose	P 90 Udo L	K 0 NoAssign
splash	P 79 Tambrn	K 0 NoAssign
pad9	P 86 Triang	K 0 NoAssign
pad10	P 11 Bongo Hi	K 0 NoAssign

No. 24 Zebulon

Input Source	Voice-1 Cat./No./Name	Voice-2 Cat./No./Name
pad1	K 14 SoTight	K 0 NoAssign
rim1	K 0 NoAssign	K 0 NoAssign
pad2	S 1 Loosy	K 0 NoAssign
rim2	S 40 BuzRgRim	K 0 NoAssign
pad3	T 79 Room2 Hi	K 0 NoAssign
rim3	K 0 NoAssign	K 0 NoAssign
pad4	T 80 Room2Mid	K 0 NoAssign
rim4	K 0 NoAssign	K 0 NoAssign
pad5	T 82 Room2Flr	K 0 NoAssign
rim5	K 0 NoAssign	K 0 NoAssign
pad6	C 24 RidesizB	K 0 NoAssign
rim6	C 33 Bell A	K 0 NoAssign
pad7	C 3 C Crash	K 0 NoAssign
rim7	C 1 CrashB	K 0 NoAssign
open	H 29 HHRoKopn	K 0 NoAssign
rimOpen	H 18 H OPMu	K 0 NoAssign
close	H 10 H QOpn13	K 0 NoAssign
rimClose	H 5 H ClsMu	K 0 NoAssign
footClose	H 31 H Pdl13	K 0 NoAssign
splash	H 48 Hpsplsh1	K 0 NoAssign
pad9	C 32 RidB Lit	K 0 NoAssign
pad10	P 33 CowB1	K 0 NoAssign

Preset Drum Kit List

No. 25 World			
Input Source	Voice-1 Cat./No./Name	Voice-2 Cat./No./Name	
pad1	P 13 Bongo Mu	K 0	NoAssign
rim1	P 80 Timb	K 0	NoAssign
pad2	P 48 Log H	K 0	NoAssign
rim2	P 39 EthWB	K 0	NoAssign
pad3	P 29 CongaO	K 0	NoAssign
rim3	P 11 Bongo Hi	K 0	NoAssign
pad4	P 29 CongaO	K 0	NoAssign
rim4	K 0 NoAssign	K 0	NoAssign
pad5	P 29 CongaO	K 0	NoAssign
rim5	P 48 Log H	K 0	NoAssign
pad6	P 80 Timb	K 0	NoAssign
rim6	P 80 Timb	K 0	NoAssign
pad7	P 25 CongaH	K 0	NoAssign
rim7	P 82 TimbL	K 0	NoAssign
open	P 25 CongaH	K 0	NoAssign
rimOpen	H 18 H OPMu	K 0	NoAssign
close	P 30 CongaS	K 0	NoAssign
rimClose	H 5 H ClsMu	K 0	NoAssign
footClose	P 30 CongaS	K 0	NoAssign
splash	H 48 Hpsplsh1	K 0	NoAssign
pad9	P 11 Bongo Hi	K 0	NoAssign
pad10	P 24 CongaG	K 0	NoAssign

No. 26 Reggae			
Input Source	Voice-1 Cat./No./Name	Voice-2 Cat./No./Name	
pad1	K 7 BD DRY 4	K 0	NoAssign
rim1	P 33 CowB1	K 0	NoAssign
pad2	S 33 12Soprno	K 0	NoAssign
rim2	S 110 S SStck2	K 0	NoAssign
pad3	P 81 TimbH	K 0	NoAssign
rim3	C 38 ChinaHi	K 0	NoAssign
pad4	P 82 TimbL	K 0	NoAssign
rim4	P 19 Clvs	K 0	NoAssign
pad5	t 32 E Tom5	K 0	NoAssign
rim5	P 90 Udo L	K 0	NoAssign
pad6	C 30 SizzLit	K 0	NoAssign
rim6	C 19 RideLite	K 0	NoAssign
pad7	C 3 C Crash	K 0	NoAssign
rim7	C 41 C Splsh1	K 0	NoAssign
open	H 10 H QOPn13	K 0	NoAssign
rimOpen	H 26 H OPrnLX1	K 0	NoAssign
close	H 2 H Cls13	K 0	NoAssign
rimClose	H 34 H PdIMu	K 0	NoAssign
footClose	H 31 H PdI13	K 0	NoAssign
splash	H 47 H Splsh3	K 0	NoAssign
pad9	C 32 RidB Lit	K 0	NoAssign
pad10	P 26 CongaM	K 0	NoAssign

No. 27 Tabla			
Input Source	Voice-1 Cat./No./Name	Voice-2 Cat./No./Name	
pad1	P 90 Udo L	K 0	NoAssign
rim1	P 2 AgogoH1	K 0	NoAssign
pad2	P 68 TablaM	K 0	NoAssign
rim2	P 26 CongaM	K 0	NoAssign
pad3	P 69 TablaN	K 0	NoAssign
rim3	P 62 Tabla B	K 0	NoAssign
pad4	P 70 TablaO	K 0	NoAssign
rim4	P 63 Tabla BL	K 0	NoAssign
pad5	P 67 TablaH	K 0	NoAssign
rim5	P 65 Tabla BV	K 0	NoAssign
pad6	P 66 Tabla OV	K 0	NoAssign
rim6	C 33 Bell A	K 0	NoAssign
pad7	P 89 Udo H	K 0	NoAssign
rim7	P 88 Udo F	K 0	NoAssign

open	P 29 CongaO	K 0	NoAssign
rimOpen	H 23 H OpnL2	K 0	NoAssign
close	P 30 CongaS	K 0	NoAssign
rimClose	H 1 H ClsO1	K 0	NoAssign
footClose	P 46 JingBell	K 0	NoAssign
splash	H 46 H SplNB	K 0	NoAssign
pad9	C 33 Bell A	K 0	NoAssign
pad10	P 3 AgogoH2	K 0	NoAssign

No. 28 Cocktail			
Input Source	Voice-1 Cat./No./Name	Voice-2 Cat./No./Name	
pad1	T 32 TOMntrIM	K 0	NoAssign
rim1	K 0 NoAssign	K 0	NoAssign
pad2	S 31 MickCJ8S	K 0	NoAssign
rim2	S 74 TrashRIM	K 0	NoAssign
pad3	T 19 Jazz Hi	K 0	NoAssign
rim3	P 81 TimbH	K 0	NoAssign
pad4	T 19 Jazz Hi	K 0	NoAssign
rim4	P 81 TimbH	K 0	NoAssign
pad5	P 33 CowB1	K 0	NoAssign
rim5	C 39 MinChina	K 0	NoAssign
pad6	C 19 RideLite	K 0	NoAssign
rim6	C 19 RideLite	K 0	NoAssign
pad7	C 41 C Splsh1	K 0	NoAssign
rim7	C 9 PaperThn	K 0	NoAssign
open	H 27 H OpnMU	K 0	NoAssign
rimOpen	H 18 H OPMu	K 0	NoAssign
close	H 8 H ClsTc3	K 0	NoAssign
rimClose	H 5 H ClsMu	K 0	NoAssign
footClose	H 34 H PdIMu	K 0	NoAssign
splash	P 79 Tambrn	K 0	NoAssign
pad9	C 32 RidB Lit	K 0	NoAssign
pad10	P 33 CowB1	K 0	NoAssign

No. 29 JamKit99			
Input Source	Voice-1 Cat./No./Name	Voice-2 Cat./No./Name	
pad1	k 17 Sub2	k 30 MtIPoint	
rim1	K 0 NoAssign	K 0	NoAssign
pad2	S 18 Tosh Sn	k 30 MtIPoint	
rim2	e 54 DUCKSTER	K 0	NoAssign
pad3	e 41 D&FRAG11	K 0	NoAssign
rim3	t 28 AnaIndsM	K 0	NoAssign
pad4	e 65 RADAMACU	K 0	NoAssign
rim4	t 27 AnaIndsH	K 0	NoAssign
pad5	e 18 JNGBASS8	e 30 SEAMNSTR	
rim5	t 30 AnaIndsF	K 0	NoAssign
pad6	e 69 WAKX PAD	C 10 ReverseC	
rim6	C 45 Ride Anl	K 0	NoAssign
pad7	e 58 GOWAH	K 0	NoAssign
rim7	C 44 AngCym	K 0	NoAssign
open	H 23 H OpnL2	K 0	NoAssign
rimOpen	H 25 H OpnLK	K 0	NoAssign
close	H 24 H OpnL3	K 0	NoAssign
rimClose	H 23 H OpnL2	K 0	NoAssign
footClose	H 32 H PdIDW	K 0	NoAssign
splash	H 48 Hpsplsh1	K 0	NoAssign
pad9	C 33 Bell A	K 0	NoAssign
pad10	P 33 CowB1	K 0	NoAssign

No. 30 GoezOn!?			
Input Source	Voice-1 Cat./No./Name	Voice-2 Cat./No./Name	
pad1	k 12 BDDance9	e 20 BDSUBSNK	
rim1	K 0 NoAssign	K 0	NoAssign
pad2	s 24 Brsh H	s 18 Dance06	
rim2	s 6 AnalogH1	K 0	NoAssign
pad3	s 3 AnaHit	e 22 SPIKER	

rim3	T 0 NoAssign	K 0	NoAssign
pad4	H 17 HHbrtcls	K 0	NoAssign
rim4	T 0 NoAssign	K 0	NoAssign
pad5	L 9 SNAPLOOP	K 0	NoAssign
rim5	T 0 NoAssign	K 0	NoAssign
pad6	e 74 Vocal04	K 0	NoAssign
rim6	C 0 NoAssign	K 0	NoAssign
pad7	e 53 DOPPLER	K 0	NoAssign
rim7	E 33 HandyDad	K 0	NoAssign
open	H 23 H OpnL2	K 0	NoAssign
rimOpen	H 25 H OpnLK	K 0	NoAssign
close	H 24 H OpnL3	K 0	NoAssign
rimClose	H 23 H OpnL2	K 0	NoAssign
footClose	H 31 H PdI13	K 0	NoAssign
splash	H 48 Hpsplsh1	K 0	NoAssign
pad9	E 13 CBRadi	K 0	NoAssign
pad10	P 33 CowB1	K 0	NoAssign

No. 31 InDaHood			
Input Source	Voice-1 Cat./No./Name	Voice-2 Cat./No./Name	
pad1	K 2 2HedMed2	K 28 BD ROOM2	
rim1	K 0 NoAssign	K 0	NoAssign
pad2	S 5 Binky	s 120 Manycure	
rim2	S 28 RIMhipop	K 0	NoAssign
pad3	T 1 Dry1 Hi	K 0	NoAssign
rim3	T 11 Maple10	K 0	NoAssign
pad4	C 16 RideDark	C 29 Sizzler	
rim4	C 6 DeepDRK	C 18 Ride'EM	
pad5	T 3 Dry1 Lo	K 0	NoAssign
rim5	T 13 Maple14	K 0	NoAssign
pad6	C 39 MinChina	K 0	NoAssign
rim6	C 33 Bell A	K 0	NoAssign
pad7	P 41 GONG	K 0	NoAssign
rim7	C 11 SoftRoll	K 0	NoAssign
open	H 24 H OpnL3	K 0	NoAssign
rimOpen	H 25 H OpnLK	K 0	NoAssign
close	H 17 HHbrtcls	K 0	NoAssign
rimClose	H 23 H OpnL2	K 0	NoAssign
footClose	H 31 H PdI13	K 0	NoAssign
splash	H 48 Hpsplsh1	K 0	NoAssign
pad9	C 40 Clusher	K 0	NoAssign
pad10	P 33 CowB1	K 0	NoAssign

No. 32 GroovKit			
Input Source	Voice-1 Cat./No./Name	Voice-2 Cat./No./Name	
pad1	K 4 BD DRY 1	K 30 MapleAmb	
rim1	K 0 NoAssign	K 0	NoAssign
pad2	s 120 Manycure	S 8 MapleV65	
rim2	S 28 RIMhipop	K 0	NoAssign
pad3	T 1 Dry1 Hi	K 0	NoAssign
rim3	T 11 Maple10	K 0	NoAssign
pad4	C 16 RideDark	C 29 Sizzler	
rim4	C 8 FastCras	C 38 ChinaHi	
pad5	T 3 Dry1 Lo	K 0	NoAssign
rim5	T 13 Maple14	K 0	NoAssign
pad6	● pad song :90 BsGroov		
rim6	C 33 Bell A	K 0	NoAssign
pad7	● pad song :91 D&B07		
rim7	C 11 SoftRoll	K 0	NoAssign
open	H 24 H OpnL3	K 0	NoAssign
rimOpen	H 25 H OpnLK	K 0	NoAssign
close	H 17 HHbrtcls	K 0	NoAssign
rimClose	H 23 H OpnL2	K 0	NoAssign
footClose	H 31 H PdI13	K 0	NoAssign
splash	H 48 Hpsplsh1	K 0	NoAssign
pad9	C 40 Clusher	K 0	NoAssign
pad10	P 33 CowB1	K 0	NoAssign

No. 33 Bs. @ Base

Input Source	Voice-1 Cat./No./Name	Voice-2 Cat./No./Name
pad1	k 32 Walkik	k 18 Sub3
rim1	K 0 NoAssign	K 0 NoAssign
pad2	s 118 Shotgun	e 8 JNGLSN8
rim2	s 80 S Gate1	K 0 NoAssign
pad3	● pad song : 89 HornGrv	
rim3	K 0 NoAssign	K 0 NoAssign
pad4	L 4 LITELOOP	K 0 NoAssign
rim4	K 0 NoAssign	K 0 NoAssign
pad5	● pad song : 88 Jko?Naa	
rim5	K 0 NoAssign	K 0 NoAssign
pad6	e 34 DOOMED	K 0 NoAssign
rim6	e 37 MOSHER	K 0 NoAssign
pad7	e 45 GRONKER	K 0 NoAssign
rim7	e 66 UMK 47	K 0 NoAssign
open	H 18 H OPMu	K 0 NoAssign
rimOpen	H 18 H OPMu	K 0 NoAssign
close	H 5 H ClsMu	K 0 NoAssign
rimClose	H 5 H ClsMu	K 0 NoAssign
footClose	H 34 H PdIMu	K 0 NoAssign
splash	H 48 Hpsplsh1	K 0 NoAssign
pad9	C 32 RidB Lit	K 0 NoAssign
pad10	P 33 CowB1	K 0 NoAssign

No. 34 JungleNY

Input Source	Voice-1 Cat./No./Name	Voice-2 Cat./No./Name
pad1	k 10 BDdance5	K 0 NoAssign
rim1	K 0 NoAssign	K 0 NoAssign
pad2	e 82 FRAG05	K 0 NoAssign
rim2	e 38 D&BFRAG8	K 0 NoAssign
pad3	e 12 JNGBASS2	K 0 NoAssign
rim3	K 0 NoAssign	K 0 NoAssign
pad4	e 81 FRAG11	K 0 NoAssign
rim4	K 0 NoAssign	K 0 NoAssign
pad5	e 41 D&FRAG11	K 0 NoAssign
rim5	K 0 NoAssign	K 0 NoAssign
pad6	C 24 RidesizB	K 0 NoAssign
rim6	e 36 TRANQUL	K 0 NoAssign
pad7	e 36 TRANQUL	K 0 NoAssign
rim7	e 36 TRANQUL	K 0 NoAssign
open	H 30 HHopen#1	K 0 NoAssign
rimOpen	H 18 H OPMu	K 0 NoAssign
close	H 17 HHbrtcls	K 0 NoAssign
rimClose	H 5 H ClsMu	K 0 NoAssign
footClose	H 36 H PdTit	K 0 NoAssign
splash	H 43 FTsplRK2	K 0 NoAssign
pad9	C 32 RidB Lit	K 0 NoAssign
pad10	P 33 CowB1	K 0 NoAssign

No. 35 Snapkit

Input Source	Voice-1 Cat./No./Name	Voice-2 Cat./No./Name
pad1	e 16 JNGBASS6	K 0 NoAssign
rim1	K 0 NoAssign	K 0 NoAssign
pad2	e 56 PANKY	K 0 NoAssign
rim2	e 84 FRAG20	K 0 NoAssign
pad3	e 24 PULSAR2	K 0 NoAssign
rim3	K 0 NoAssign	K 0 NoAssign
pad4	e 40 WYZOG	K 0 NoAssign
rim4	K 0 NoAssign	K 0 NoAssign
pad5	L 9 SNAPLOOP	K 0 NoAssign
rim5	K 0 NoAssign	K 0 NoAssign
pad6	E 44 INDrde	K 0 NoAssign
rim6	e 64 RUNNER	K 0 NoAssign
pad7	e 39 PEEPER	K 0 NoAssign
rim7	e 55 TAMTAMY	K 0 NoAssign

open	H 50 H OpnAn	K 0 NoAssign
rimOpen	H 18 H OPMu	K 0 NoAssign
close	H 3 H ClsA1	K 0 NoAssign
rimClose	H 5 H ClsMu	K 0 NoAssign
footClose	H 36 H PdTit	K 0 NoAssign
splash	H 43 FTsplRK2	K 0 NoAssign
pad9	C 32 RidB Lit	K 0 NoAssign
pad10	P 33 CowB1	K 0 NoAssign

No. 36 JumpBack

Input Source	Voice-1 Cat./No./Name	Voice-2 Cat./No./Name
pad1	K 30 MapleAmb	K 0 NoAssign
rim1	K 0 NoAssign	K 0 NoAssign
pad2	e 3 JNGLSN3	K 0 NoAssign
rim2	S 28 RIMhipop	K 0 NoAssign
pad3	E 80 TungDrum	K 0 NoAssign
rim3	K 0 NoAssign	K 0 NoAssign
pad4	● pad song : 83 Photon	
rim4	K 0 NoAssign	K 0 NoAssign
pad5	● pad song : 84 Ganoosh	
rim5	K 0 NoAssign	K 0 NoAssign
pad6	E 45 INDrde2	K 0 NoAssign
rim6	e 42 SCRUNCH	K 0 NoAssign
pad7	C 4 C CrshAC	K 0 NoAssign
rim7	C 3 C Crash	K 0 NoAssign
open	H 29 HHRoKopn	K 0 NoAssign
rimOpen	H 18 H OPMu	K 0 NoAssign
close	H 2 H Cls13	K 0 NoAssign
rimClose	H 5 H ClsMu	K 0 NoAssign
footClose	H 36 H PdTit	K 0 NoAssign
splash	H 43 FTsplRK2	K 0 NoAssign
pad9	C 32 RidB Lit	K 0 NoAssign
pad10	P 33 CowB1	K 0 NoAssign

No. 37 MondoKit

Input Source	Voice-1 Cat./No./Name	Voice-2 Cat./No./Name
pad1	K 33 BD MONDO	K 0 NoAssign
rim1	K 0 NoAssign	K 0 NoAssign
pad2	e 5 JNGLSN5	K 0 NoAssign
rim2	S 118 SnareLes	K 0 NoAssign
pad3	t 8 Ana 2flr	K 0 NoAssign
rim3	K 0 NoAssign	K 0 NoAssign
pad4	● pad song : 79 Peaceout	
rim4	K 0 NoAssign	K 0 NoAssign
pad5	● pad song : 80 Kinetic	
rim5	K 0 NoAssign	K 0 NoAssign
pad6	C 36 RidB Rc	K 0 NoAssign
rim6	e 37 MOSHER	K 0 NoAssign
pad7	C 5 CrshDRK	K 0 NoAssign
rim7	E 40 INDrash	K 0 NoAssign
open	H 25 H OpnLK	K 0 NoAssign
rimOpen	H 18 H OPMu	K 0 NoAssign
close	H 7 H ClsTc1	K 0 NoAssign
rimClose	H 5 H ClsMu	K 0 NoAssign
footClose	H 41 Hpdclcs4	K 0 NoAssign
splash	H 43 FTsplRK2	K 0 NoAssign
pad9	C 32 RidB Lit	K 0 NoAssign
pad10	P 33 CowB1	K 0 NoAssign

No. 38 Torqkit

Input Source	Voice-1 Cat./No./Name	Voice-2 Cat./No./Name
pad1	K 24 2HeadHi	K 0 NoAssign
rim1	K 0 NoAssign	K 0 NoAssign
pad2	e 48 JNGSN11	K 0 NoAssign
rim2	e 8 JNGLSN8	K 0 NoAssign
pad3	T 19 Jazz Hi	K 0 NoAssign

rim3	K 0 NoAssign	K 0 NoAssign
pad4	● pad song : 85 Babaj	
rim4	K 0 NoAssign	K 0 NoAssign
pad5	● pad song : 86 NxtGene.	
rim5	K 0 NoAssign	K 0 NoAssign
pad6	C 18 Ride'EM	K 0 NoAssign
rim6	e 59 DEEPDIVE	K 0 NoAssign
pad7	P 21 Conga	K 0 NoAssign
rim7	C 40 Clusher	K 0 NoAssign
open	H 50 H OpnAn	K 0 NoAssign
rimOpen	H 18 H OPMu	K 0 NoAssign
close	H 3 H ClsA1	K 0 NoAssign
rimClose	H 5 H ClsMu	K 0 NoAssign
footClose	H 36 H PdTit	K 0 NoAssign
splash	H 43 FTsplRK2	K 0 NoAssign
pad9	C 32 RidB Lit	K 0 NoAssign
pad10	P 33 CowB1	K 0 NoAssign

No. 38 Mystery

Input Source	Voice-1 Cat./No./Name	Voice-2 Cat./No./Name
pad1	k 24 BDNIN1	K 0 NoAssign
rim1	K 0 NoAssign	K 0 NoAssign
pad2	e 76 FRAG14	e 82 FRAG05
rim2	e 1 JNGLSN1	K 0 NoAssign
pad3	● pad song : 93 Suspens2	
rim3	K 0 NoAssign	K 0 NoAssign
pad4	● pad song : 95 0	
rim4	K 0 NoAssign	K 0 NoAssign
pad5	● pad song : 94 Suspens3	
rim5	K 0 NoAssign	K 0 NoAssign
pad6	C 30 SizzLit	K 0 NoAssign
rim6	C 19 RideLite	K 0 NoAssign
pad7	C 3 C Crash	C 37 China
rim7	C 1 CrashB	C 37 China
open	H 18 H OPMu	K 0 NoAssign
rimOpen	H 18 H OPMu	K 0 NoAssign
close	H 5 H ClsMu	K 0 NoAssign
rimClose	H 5 H ClsMu	K 0 NoAssign
footClose	H 34 H PdIMu	K 0 NoAssign
splash	H 48 Hpsplsh1	K 0 NoAssign
pad9	C 32 RidB Lit	K 0 NoAssign
pad10	e 46 SEMILOOP	K 0 NoAssign

No. 40 GM std 1

Input Source	Voice-1 Cat./No./Name	Voice-2 Cat./No./Name
pad1	K 17 BDaffty1	K 0 NoAssign
rim1	K 0 NoAssign	K 0 NoAssign
pad2	S 1 Loosy	K 0 NoAssign
rim2	S 79 OpnRim	K 0 NoAssign
pad3	T 6 DRY GM5	K 0 NoAssign
rim3	T 6 DRY GM5	K 0 NoAssign
pad4	T 7 DRY GM4	K 0 NoAssign
rim4	T 7 DRY GM4	K 0 NoAssign
pad5	T 9 DRY GM2	K 0 NoAssign
rim5	T 9 DRY GM2	K 0 NoAssign
pad6	C 30 SizzLit	K 0 NoAssign
rim6	C 19 RideLite	K 0 NoAssign
pad7	C 3 C Crash	K 0 NoAssign
rim7	C 1 CrashB	K 0 NoAssign
open	H 18 H OPMu	K 0 NoAssign
rimOpen	H 18 H OPMu	K 0 NoAssign
close	H 5 H ClsMu	K 0 NoAssign
rimClose	H 5 H ClsMu	K 0 NoAssign
footClose	H 34 H PdIMu	K 0 NoAssign
splash	H 48 Hpsplsh1	K 0 NoAssign
pad9	C 32 RidB Lit	K 0 NoAssign
pad10	P 33 CowB1	K 0 NoAssign

Preset Drum Kit List

No. 41 GM std 2

Input Source	Voice-1 Cat./No./Name	Voice-2 Cat./No./Name		
pad1	K 19 MapleA20	K 0	NoAssign	
rim1	K 0	NoAssign	K 0	NoAssign
pad2	S 98 Steel65	K 0	NoAssign	
rim2	S 91 OpnRimC	K 0	NoAssign	
pad3	T 6 DRY GM5	K 0	NoAssign	
rim3	T 6 DRY GM5	K 0	NoAssign	
pad4	T 7 DRY GM4	K 0	NoAssign	
rim4	T 7 DRY GM4	K 0	NoAssign	
pad5	T 9 DRY GM2	K 0	NoAssign	
rim5	T 9 DRY GM2	K 0	NoAssign	
pad6	C 30 SizzLit	K 0	NoAssign	
rim6	C 19 RideLite	K 0	NoAssign	
pad7	C 3 C Crash	K 0	NoAssign	
rim7	C 1 CrashB	K 0	NoAssign	
open	H 18 H OPMu	K 0	NoAssign	
rimOpen	H 18 H OPMu	K 0	NoAssign	
close	H 5 H ClsMu	K 0	NoAssign	
rimClose	H 5 H ClsMu	K 0	NoAssign	
footClose	H 34 H PdlMu	K 0	NoAssign	
splash	H 48 Hpsplsh1	K 0	NoAssign	
pad9	C 32 RidB Lit	K 0	NoAssign	
pad10	P 33 CowB1	K 0	NoAssign	

No. 42 GM room

Input Source	Voice-1 Cat./No./Name	Voice-2 Cat./No./Name		
pad1	K 34 BDbasc2	K 0	NoAssign	
rim1	K 0	NoAssign	K 0	NoAssign
pad2	S 1 Loosy	K 0	NoAssign	
rim2	S 79 OpnRim	K 0	NoAssign	
pad3	T 52 Room 5	K 0	NoAssign	
rim3	T 52 Room 5	K 0	NoAssign	
pad4	T 53 Room 4	K 0	NoAssign	
rim4	T 53 Room 4	K 0	NoAssign	
pad5	T 55 Room 2	K 0	NoAssign	
rim5	T 55 Room 2	K 0	NoAssign	
pad6	C 30 SizzLit	K 0	NoAssign	
rim6	C 19 RideLite	K 0	NoAssign	
pad7	C 3 C Crash	K 0	NoAssign	
rim7	C 1 CrashB	K 0	NoAssign	
open	H 18 H OPMu	K 0	NoAssign	
rimOpen	H 18 H OPMu	K 0	NoAssign	
close	H 5 H ClsMu	K 0	NoAssign	
rimClose	H 5 H ClsMu	K 0	NoAssign	
footClose	H 34 H PdlMu	K 0	NoAssign	
splash	H 48 Hpsplsh1	K 0	NoAssign	
pad9	C 32 RidB Lit	K 0	NoAssign	
pad10	P 33 CowB1	K 0	NoAssign	

No. 43 GM rock

Input Source	Voice-1 Cat./No./Name	Voice-2 Cat./No./Name		
pad1	K 22 Bdvman	K 0	NoAssign	
rim1	K 0	NoAssign	K 0	NoAssign
pad2	S 97 Brass55	S 47	RIMnatrl	
rim2	S 79 OpnRim	K 0	NoAssign	
pad3	T 58 Rock 5	K 0	NoAssign	
rim3	T 58 Rock 5	K 0	NoAssign	
pad4	T 59 Rock 4	K 0	NoAssign	
rim4	T 59 Rock 4	K 0	NoAssign	
pad5	T 61 Rock 2	K 0	NoAssign	
rim5	T 61 Rock 2	K 0	NoAssign	
pad6	C 30 SizzLit	K 0	NoAssign	
rim6	C 19 RideLite	K 0	NoAssign	
pad7	C 3 C Crash	K 0	NoAssign	
rim7	C 1 CrashB	K 0	NoAssign	

open	H 18	H OPMu	K 0	NoAssign
rimOpen	H 18	H OPMu	K 0	NoAssign
close	H 5	H ClsMu	K 0	NoAssign
rimClose	H 5	H ClsMu	K 0	NoAssign
footClose	H 34	H PdlMu	K 0	NoAssign
splash	H 48	Hpsplsh1	K 0	NoAssign
pad9	C 32	RidB Lit	K 0	NoAssign
pad10	P 33	CowB1	K 0	NoAssign

No. 44 GM elec.

Input Source	Voice-1 Cat./No./Name	Voice-2 Cat./No./Name		
pad1	K 42 BD GateM	K 0	NoAssign	
rim1	K 0	NoAssign	K 0	NoAssign
pad2	S 104 Gate	K 0	NoAssign	
rim2	S 79 OpnRim	K 0	NoAssign	
pad3	t 32 E Tom5	K 0	NoAssign	
rim3	t 32 E Tom5	K 0	NoAssign	
pad4	t 33 E Tom4	K 0	NoAssign	
rim4	t 33 E Tom4	K 0	NoAssign	
pad5	t 35 E Tom2	K 0	NoAssign	
rim5	t 35 E Tom2	K 0	NoAssign	
pad6	C 30 SizzLit	K 0	NoAssign	
rim6	C 19 RideLite	K 0	NoAssign	
pad7	C 3 C Crash	K 0	NoAssign	
rim7	C 1 CrashB	K 0	NoAssign	
open	H 18 H OPMu	K 0	NoAssign	
rimOpen	H 18 H OPMu	K 0	NoAssign	
close	H 5 H ClsMu	K 0	NoAssign	
rimClose	H 5 H ClsMu	K 0	NoAssign	
footClose	H 34 H PdlMu	K 0	NoAssign	
splash	H 48 Hpsplsh1	K 0	NoAssign	
pad9	C 32 RidB Lit	K 0	NoAssign	
pad10	P 33 CowB1	K 0	NoAssign	

No. 45 GM anal.

Input Source	Voice-1 Cat./No./Name	Voice-2 Cat./No./Name		
pad1	k 1 AnaQuick	K 0	NoAssign	
rim1	K 0	NoAssign	K 0	NoAssign
pad2	s 13 Dance	K 0	NoAssign	
rim2	S 79 OpnRim	K 0	NoAssign	
pad3	t 10 AnlgTom5	K 0	NoAssign	
rim3	t 10 AnlgTom5	K 0	NoAssign	
pad4	t 11 AnlgTom4	K 0	NoAssign	
rim4	t 11 AnlgTom4	K 0	NoAssign	
pad5	t 13 AnlgTom2	K 0	NoAssign	
rim5	t 13 AnlgTom2	K 0	NoAssign	
pad6	C 30 SizzLit	K 0	NoAssign	
rim6	C 19 RideLite	K 0	NoAssign	
pad7	C 44 AngCym	K 0	NoAssign	
rim7	C 1 CrashB	K 0	NoAssign	
open	H 49 H OpnAMu	K 0	NoAssign	
rimOpen	H 49 H OpnAMu	K 0	NoAssign	
close	H 3 H ClsA1	K 0	NoAssign	
rimClose	H 3 H ClsA1	K 0	NoAssign	
footClose	H 4 H ClsA2	K 0	NoAssign	
splash	H 48 Hpsplsh1	K 0	NoAssign	
pad9	C 32 RidB Lit	K 0	NoAssign	
pad10	P 35 CowBAN	K 0	NoAssign	

No. 46 GM jazz

Input Source	Voice-1 Cat./No./Name	Voice-2 Cat./No./Name		
pad1	K 2 2HedMed2	K 0	NoAssign	
rim1	K 0	NoAssign	K 0	NoAssign
pad2	S 17 LiteSnr1	K 0	NoAssign	
rim2	S 79 OpnRim	K 0	NoAssign	
pad3	T 19 Jazz Hi	K 0	NoAssign	

rim3	T 19 Jazz Hi	K 0	NoAssign
pad4	T 20 Jazz Mid	K 0	NoAssign
rim4	T 20 Jazz Mid	K 0	NoAssign
pad5	T 22 Jazz Flr	K 0	NoAssign
rim5	T 22 Jazz Flr	K 0	NoAssign
pad6	C 30 SizzLit	K 0	NoAssign
rim6	C 19 RideLite	K 0	NoAssign
pad7	C 3 C Crash	K 0	NoAssign
rim7	C 1 CrashB	K 0	NoAssign
open	H 18 H OPMu	K 0	NoAssign
rimOpen	H 18 H OPMu	K 0	NoAssign
close	H 5 H ClsMu	K 0	NoAssign
rimClose	H 5 H ClsMu	K 0	NoAssign
footClose	H 34 H PdlMu	K 0	NoAssign
splash	H 48 Hpsplsh1	K 0	NoAssign
pad9	C 32 RidB Lit	K 0	NoAssign
pad10	P 33 CowB1	K 0	NoAssign

No. 47 GM brush

Input Source	Voice-1 Cat./No./Name	Voice-2 Cat./No./Name		
pad1	K 2 2HedMed2	K 0	NoAssign	
rim1	K 0	NoAssign	K 0	NoAssign
pad2	s 113 BrSwH*	K 0	NoAssign	
rim2	S 79 OpnRim	K 0	NoAssign	
pad3	T 23 BrshJzHi	K 0	NoAssign	
rim3	T 23 BrshJzHi	K 0	NoAssign	
pad4	T 24 BrshJzMd	K 0	NoAssign	
rim4	T 24 BrshJzMd	K 0	NoAssign	
pad5	T 26 BrshJzFl	K 0	NoAssign	
rim5	T 26 BrshJzFl	K 0	NoAssign	
pad6	C 30 SizzLit	K 0	NoAssign	
rim6	C 19 RideLite	K 0	NoAssign	
pad7	C 3 C Crash	K 0	NoAssign	
rim7	C 1 CrashB	K 0	NoAssign	
open	H 18 H OPMu	K 0	NoAssign	
rimOpen	H 18 H OPMu	K 0	NoAssign	
close	H 5 H ClsMu	K 0	NoAssign	
rimClose	H 5 H ClsMu	K 0	NoAssign	
footClose	H 34 H PdlMu	K 0	NoAssign	
splash	H 48 Hpsplsh1	K 0	NoAssign	
pad9	C 32 RidB Lit	K 0	NoAssign	
pad10	P 33 CowB1	K 0	NoAssign	

No. 48 GM class

Input Source	Voice-1 Cat./No./Name	Voice-2 Cat./No./Name		
pad1	K 7 BD DRY 4	K 0	NoAssign	
rim1	K 0	NoAssign	K 0	NoAssign
pad2	S 85 ParadeS	K 0	NoAssign	
rim2	S 79 OpnRim	K 0	NoAssign	
pad3	T 15 Lite Hi	K 0	NoAssign	
rim3	T 15 Lite Hi	K 0	NoAssign	
pad4	T 16 Lite Mid	K 0	NoAssign	
rim4	T 16 Lite Mid	K 0	NoAssign	
pad5	T 18 Lite Flr	K 0	NoAssign	
rim5	T 18 Lite Flr	K 0	NoAssign	
pad6	C 48 HCymClsl	K 0	NoAssign	
rim6	C 47 HCym2	K 0	NoAssign	
pad7	C 50 HCymOpnl	K 0	NoAssign	
rim7	C 51 HCymOpnl	K 0	NoAssign	
open	H 18 H OPMu	K 0	NoAssign	
rimOpen	H 18 H OPMu	K 0	NoAssign	
close	H 5 H ClsMu	K 0	NoAssign	
rimClose	H 5 H ClsMu	K 0	NoAssign	
footClose	H 34 H PdlMu	K 0	NoAssign	
splash	H 48 Hpsplsh1	K 0	NoAssign	
pad9	C 32 RidB Lit	K 0	NoAssign	
pad10	P 33 CowB1	K 0	NoAssign	

Preset Song List

● : Kits used with the pad songs

Song		Drum Kit	
No.	Song Name	No.	Kit Name
1	Latiniq	1	Acoustic
2	ZEBULON	24	Zebulon
3	JungleNY	34	JungleNY
4	BigDadd	40	GM std 1
5	Metizo	40	GM std 1
6	Muses	40	GM std 1
7	Vee Bop	10	BeBop
8	FeelNite	41	GM std 2
9	Straight	40	GM std 1
10	Samba 1	40	GM std 1
11	Samba 2	40	GM std 1
12	8beat 1	40	GM std 1
13	8beat 2	40	GM std 1
14	16 beat	40	GM std 1
15	HdRck 1	43	GM rock
16	HdRck 2	43	GM rock
17	HdRck 3	43	GM rock
18	HdRck 4	43	GM rock
19	SlowRock	40	GM std 1
20	Ballad1	40	GM std 1
21	Ballad2	40	GM std 1
22	Ballad3	40	GM std 1
23	Ballad4	46	GM jazz
24	Ballad5	45	GM anal.
25	Ballad6	40	GM std 1
26	Ballad7	45	GM anal.
27	Ballad8	40	GM std 1
28	RckPop1	40	GM std 1
29	RckPop2	46	GM jazz
30	RckPop3	43	GM rock
31	RckPop4	46	GM jazz
32	RckPop5	42	GM room
33	RckPop6	46	GM jazz
34	Dance 1	17	Dance 2
35	Dance 2	45	GM anal.

Song		Drum Kit	
No.	Song Name	No.	Kit Name
36	Dance 3	45	GM anla.
37	Dance 4	44	GM elec.
38	Latin 1	40	GM std 1
39	Latin 2	23	LatinPer
40	Latin 3	23	LatinPer
41	Latin 4	40	GM std 1
42	Latin 5	40	GM std 1
43	Latin 6	40	GM std 1
44	Latin 7	40	GM std 1
45	Latin 8	46	GM jazz
46	Latin 9	40	GM std 1
47	Latin10	46	GM jazz
48	Jazz 1	46	GM jazz
49	Jazz 2	46	GM jazz
50	Jazz 3	40	GM std 1
51	Jazz 4	1	Acoustic
52	Jazz 5	52	GM brush
53	Jazz 6	1	Acoustic
54	Jazz 7	47	GM brush
55	R&B 1	40	GM std 1
56	R&B 2	46	GM jazz
57	R&B 3	42	GM room
58	R&B 4	44	GM elec.
59	R&B 5	46	GM jazz
60	R&B 6	46	GM jazz
61	R&B 7	40	GM std 1
62	R'n'R 1	40	GM std 1
63	R'n'R 2	40	GM std 1
64	Funk 1	40	GM std 1
65	Funk 2	40	GM std 1
66	Funk 3	40	GM std 1
67	Funk 4	40	GM std 1
68	Funk 5	40	GM std 1
69	Reggae1	42	GM room
70	Reggae2	45	GM anal.

Song		Drum Kit	
No.	Song Name	No.	Kit Name
71	World 1	42	GM room
72	World 2	40	GM std 1
73	Shuffle1	40	GM std 1
74	Shuffle2	40	GM std 1
75	Fusion 1	40	GM std 1
76	Fusion 2	40	GM std 1
77	ShamanX	37	MondoKit ●
78	Stepoff	37	MondoKit ●
79	TriTown	37	MondoKit ●
80	Peaceout	37	MondoKit ●
81	Kinetic	36	JumpBack ●
82	Thwak!	36	JumpBack ●
83	Pulsar	36	JumpBack ●
84	Photon	36	JumpBack ●
85	Ganoosh	38	TorqKit ●
86	Babaj	38	TorqKit ●
87	NxtGene.	31	InDaHood
88	PadBass	33	Bs.@Base ●
89	Jko?Naa	33	Bs.@Base ●
90	HornGrv	32	GroovKit ●
91	BsGroov	32	GroovKit ●
92	D&B07	39	Mistry ●
93	Suspens1	39	Mistry ●
94	Suspens2	39	Mistry ●
95	Suspens3	39	Mistry ●

Trigger Setup List

No.	Name	Description
1	Medium	Normal Setting
2	Dynamic	Wide Dynamic Range however, sensitive to vibration.
3	Easy	Averages irregular trigger levels, produces smoother sound
4	HH->BD	A hi-hat controller connected to the trigger input jack "1 KICK" can be used as a kick pedal.
5	DT10/20	Use with DT10/20 drum triggers attached to acoustic drums.
6	LatinSet	Setting for Latin Set
7	Exp Set	Setting for Expansion Set

MIDI Data Format

1. Channel Message

When the [2-2. Channel 10 Program Change/Channel Event Receive] (P. 54) in the utility mode is set to "10=off", the DTXPRESS will not receive channel message for MIDI channel 10.

1.1 Key On Key Off

Sends and receives data.

Receive note range: C-2 to G8

Velocity range: 1 to 127 (note on only)

1.2 Control Change

All control change data for sequencer functions can be received and transmitted. The following lists the tone generator functions and drum trigger functions.

1.2.1 bank select MSB-0

Sends and receives data.

data=0:normal voice

data=127:drum voice

The data will not be processed unless program change data is received.

1.2.2 modulation (No. 1)

Receives only.

1.2.3 foot controller (No. 4)

Sends and receives data.

1.2.3 data entry (No. 6)

Receives only. Used to specify RPN data.

1.2.5 main volume (No. 7)

Sends and receives data.

1.2.6 pan (No. 10)

Sends and receives data.

0 is the far left of a stereo image and 127 is the far right of a stereo image.

1.2.7 expression (No. 11)

Receives only.

1.2.8 hold1 (No. 64)

Receives only.

1.2.9 harmonic content (No. 71)

Receives only.

1.2.10 release time (No. 72)

Receives only.

1.2.11 attack time (No. 73)

Receives only.

1.2.12 brightness (No. 74)

Receives only.

1.2.13 portamento control (No. 84)

Receives only.

1.2.14 effect 1 depth (No. 91)

Receives only. Only effects the reverb send level.

1.2.15 data increment/decrement (No. 100/101)

Receives only.

1.2.16 RPN

00/00 pitch bend sensitivity: Receive only.

00/01 fine tuning: Receive only.

00/02 coarse tuning: Receive only.

7F/7F NULL: Receive only.

1.3 Channel Mode Message

All channel mode messages are received only.

1.3.1 all sound off (No. 120)

Mutes all the sounds currently playing through the specified channel.

1.3.2 reset all controllers (No. 121)

Sets the following controller values back to its initial value:

pitch bend, modulation, expression, hold1, portamento control,

RPN number

1.3.3 all note off (No. 123)

Turns off all the notes of the specified channel currently on.

They will however, not be muted unless "hold 1" is turned off.

1.3.4 omni off (No. 124)

Executes the same process as "all note off".

1.3.5 omni on (No. 125)

Executes the same process as "all note off".

1.3.6 mono (No. 126)

Executes the same process as "all sound off".

1.3.7 poly (No. 127)

Executes the same process as "all sound off".

1.4 Program Change

When the [2-3. Receive Program Change/System Exclusive Messages] (P. 54) in the utility mode is set to "PC=off", the DTXPRESS will not receive program change data.

When the [2-2. Channel 10 Program Change/Channel Event Receive] (P. 54) in the utility mode is set to "10PC=off", the DTXPRESS will not receive MIDI channel 10 program change data.

1.5 Pitch Bend

Sends and receives data.

1.6 Channel Aftertouch

Does not send or receive data.

1.7 Polyphonic Aftertouch

Does not send or receive data.

2. System Exclusive Message

When the [2-3. Receive Program Change/System Exclusive Messages] (P. 54) in the utility mode is set to "SySex=off", the DTXPRESS will not receive system exclusive messages.

The DTXPRESS will not receive system exclusive messages that do not match the device number set in the "DevNo=" of the [2-6. Device Number, Local Control] (P. 55) in the utility mode.

2.1 Parameter Change

2.1.1 GM system ON

F0 7E 7F 09 01 F7

Sets all the data except the MIDI master tuning data to its initial value.
Sends and receives data.

2.1.2 XG system ON

F0 43 1n 4C 00 00 7E 00 F7

"n" stands for device number.
Executes the same process as GM system ON.
Receives only.

2.1.3 identify request

F0 7E 0n 06 01 F7

"n" stands for device number.
After receiving, the identify reply is transmitted.
Receives only.

2.1.4 MIDI master volume

F0 7F 7F 04 01 XX mm F7

Ignores "XX". "mm" is the volume.
Receives only.

2.1.5 MIDI master tune

F0 43 1n 27 30 00 00 mm ll cc F7

"n" stands for device number.
The values of "mm(MSnibble)" and "ll(LSnibble)"—128 is used for 1 cent unit when tuning.
Receives only.

2.2 Bulk Dump

Sends and receives data. All the data except the system data is converted into 1 or 2 byte ASCII characters and transmitted.

• DTXPRESS bulk dump common message.

F0 43 7D Xn ss ss 44 54 58 4C("DTXL") tt tt tt ii ii jj jj dataBytes csum F7

tt tt tt tt This displays the ID of the bulk type. 4 characters of ASCII code.

ss ss data bytes (from model ID to data) MS7bit, LS7bit
ii ii data packet index number MS7bit, LS7bit
If the data size exceeds 4096, the total is divided into F0-F7 packets, the packet index number will start at 00 01 (0001) increasing by 1 for each successive packet. The last packet is 7F 7F (3FFF).

When the data size is less than 4096, it will be 00 00 (0000).
jj jj object number MS7bit, LS7bit
Object number. In the DTXPRESS system only 1 article exists, that will become 7F 7F (3FFF).

csum indicates the 7bit of the 2's complement of the sum of the data from the model ID (ss ss) to data Bytes.

2.2.1 system

F0 43 7D 0n ss ss 44 54 58 4C("DTXL") 53 59 53 54("SYST") 00 00 7F 7F data csum F7

2.2.2 map

F0 43 7D 0n ss ss 44 54 58 4C("DTXL") 55 4D 41 50("UMAP") 00 00 7F 7F data csum F7

2.2.3 drumkit

F0 43 7D 0n ss ss 44 54 58 4C("DTXL") 44 4B 49 54("DKIT") 00 00 jj jj data csum F7

jj jj Indicated by MS7bit, LS7bit. This number derived from the user drum kit number by counting from "0". In the case of the edit buffer, it is 7F 7F (3FFF).

2.2.4 trigger

F0 43 7D 0n ss ss 44 54 58 4C("DTXL") 54 52 49 47("TRIG") 00 00 jj jj data csum F7

jj jj The user trigger's number MS7bit, LS7bit.
7F 7F specifies the edit buffer

2.2.5 song

F0 43 7D 0n ss ss 44 54 58 4C("DTXL") 53 4F 4E 47("SONG") ii ii jj jj data2 csum F7

jj jj The user song number's MS7bit, LS7bit.
7F 7F specifies the current song.

data 2 Divides the original data into the 4 bits MSnibble, LSnibble, and converts 1 byte data to 2 bytes.

2.3 Dump Request

Receives only.

Transmits the corresponding bulk dump.

F0 43 7D 2n 44 54 58 4C("DTXL") tt tt tt tt ii jj F7

jj jj object number MS7bit, LS7bit
Object number. In the DTXPRESS system only 1 article exists, that will become 7F 7F (3FFF).
The object number contains the number that specifies the drum kit number, etc.
Only one article exists, system data or edit buffer data, etc., that appoints 7F 7F (3FFF).
However, 7F 7F does not correspond in the case of song data.

3. System common message

3.1 Select a song

f3 nn

"nn" stands for song number.

Receives only.

4. Realtime message

Sends and receives data.

4.1 timing clock

Synchronizes with the timing clock received when the Sync mode in the utility mode's [3-6. Sync Mode] (P. 57) is set to "ext" or "auto".

4.2 start, continue, stop

When the [3-4. MIDI Control] (P. 57) in the utility mode is set to "MIDI Control=off", the DTXPRESS will not receive start, continue and stop.

4.3 active sensing

Once active sensing data has been received, if no MIDI data is subsequently received for longer than an interval of approximately 300 msec, the DTXPRESS will mute all the sounds.

Send the messages within an interval of approximately 300 msec.

Function ...	Transmitted	Recognized	Remarks
Basic Default Channel Changed	1 - 16 1 - 16	1 - 16 1 - 16	memorized
Mode Default Messages Altered	x x *****	3 3 x	
Note Number : True voice	0 - 127 0 - 127	0 - 127 0 - 127	
Velocity Note ON Note OFF	o 9nH,v=1-127 x 9nH,v=0	o v=1-127 x	
After Key's Touch Ch's	x x	x x	
Pitch Bender	x	o	7 bit resolution
Control Change 0,4,7,10,32 1,6,11,64 71,72,73 74,84,91 100,101	o x x x x	o o o o o	
Prog Change : True #	o 0 - 127 *****	o 0 - 127	
System Exclusive	o	o	
System : Song Pos. : Song Sel. Common : Tune	x x x	x o x	
System :Clock Real Time :Commands	o o	o o	
Aux :All Sound Off :Reset All Cntrls :Local ON/OFF :All Notes OFF Mes- :Active Sense sages:Reset	x x o x o x	o o o o(123-127) o x	

Index

9/10 jack	9, 10
Ⓜ	18
Ⓜ	19, 31
Ⓜ	19, 31

A

ACCOMPANIMENT VOLUME	8, 16, 18
Acoustic Drums	11
Alternate Group	43, 61
AUX IN	8, 13

B

Backup Battery	3
Bank Select	46, 48
Battery Low	3
Beat	31

C

CLICK	8, 17, 18, 19
Click Mode	58
Click Note Number	57
Click Tune	57
Click Voice	56
CLICK VOL (Volume)	8, 17, 19
Computer	12, 26
Cord Hook	9, 13
Count	57
Cross Fade	43
Cross Talk	37, 67
Cursor	29
Cutoff Frequency	23, 42, 60

D

DC IN 12V	9
Decay	22, 42, 60
Double Trigger	29, 37
Drum Kit	
Change (Select) a Drum Kit	16, 19, 30
Create an Original Drum Kit	22, 77
Drum Kit Data	28
Drum Kit Name	23, 47
Drum Kit Play Mode	30
Drum Kit Voice Copy Mode	46
Drum Kit Voice Edit Mode	39
Preset Drum Kit	66
Save a Drum Kit (Store)	39
Drum Map	59
Drum Trigger	11
Drum Voice	19, 62
DT 10	11

E

Equalizer (EQ)	58
----------------------	----

F

Factory Preset	53
Function	44

G

Gain	36
Gate Time	42
GM Keyboard Voice List	66
Groove Check	17, 31

H

Headphone	8, 13, 16
Hi-Hat	
Hi-Hat Controller	9, 10, 56
Hi-Hat Offset	53
Hi-Hat Sensitivity	47
HI-HAT CONTROLLER Jack	9
Hold Mode	44
HOST SELECT Switch	9, 26
Host Thru Port	56

I

INPUT ATTENUATION	9
Input Sensitivity	9, 10, 36
Input Source	22

K

Key Assign Mode	43, 61
Key Off Enable	44, 61

L

Layer Balance	42, 60
Learn Mode	52
Local Control	55

M

Map Copy	61
Merge Track	50
Metronome	17, 18, 19, 31
MIDI	12, 25, 29, 53, 74
Bulk Dump	25, 53, 54
Bulk In	25
Channel Event	54
Connections	12
Device Number	55
Dump Interval	56
MIDI Control	57
MIDI Channel	42
MIDI Data Format	74
MIDI Device	12
MIDI Implementation Chart	76
MIDI IN/OUT Jack	9, 29
MIDI Merge	55
MIDI Mode	55
MIDI Note Number	42
Program Change	46, 48, 54
Program Change Table	55
System Exclusive Message	54
Minimum Velocity	36

Index

Mute	
Drum Part (Rhythm Mute)	18
Mute Drum Voice	31
Mute Individual Drums	19

N

Note	7
------------	---

O

OUTPUT Jack	9, 12
-------------------	-------

P

Pad	10, 36
Page	4, 28
Pan	22, 41, 46, 49, 60
PHONES Jack	18, 13
Power	8, 9, 13, 16
POWER/VOL	8, 16, 18

Q

Quantize	20, 34, 49
----------------	------------

R

Recording	12, 20, 34
Rejection	37
Repeat Playback	48
Replace	20, 21, 34
Reverb	45
Reverb Bypass	59
Reverb Master Return	45
Reverb Send	43, 47, 60
Reverb Type, Time	45
Rim to Pad	45

S

Save m Refer to Store	
Self-Rejection	37
Sequencer	20, 32, 56
Serial Cable	26
Serial Port	26
Setup	46
Song	32, 34
Change Tempo	18, 32, 47
Change Volume	32
Erase Data (Clear Song, Clear Track)	21, 50
Listen to a Song	18, 32, 33
Mute the Drum Part	18
Pad Song	32, 33, 44
Preset Song	18, 30, 31, 73
Repeat Playback	31, 32, 48
Recording	20, 34
Select a Song	18, 30, 31, 32
Song Copy	49
Song Job Mode	48
Song Name	21, 50
Song Select	47
User Song	20

Sound Quality	16
Specific Rejection	37
Store	
Drum Kit Voice	39
Trigger Setup	35
Synchronized Playback	25
Sync Mode	57

T

Tempo	30, 47, 48
TO HOST Jack	9, 26, 29
Tone Generator	29, 58
Track	20, 34
Trigger Bypass	52
Trigger Input Jack	9, 10
Trigger Setup	
Save a Trigger Setup	35
Select a Trigger Setup	30
Trigger Setup Copy	37
Trigger Setup Data	28
Trigger Setup Edit Mode	35
Trigger Setup List	73, 77
Trigger Setup Name	38
Tuning	22, 41, 58, 60

U

Undo	21
Use Tempo	58
Utility Mode	51

V

Velocity Curve	37
Voice	41, 59
Change Decay	22, 42
Change Reverb Level	23, 43, 47
Change Pan	22, 41
Change Tuning (Pitch)	22, 41
Change Voice Brightness	23, 41
Change Volume	16, 22, 41
Change Volume Balance	23, 42
Save (Store)	25, 39
Volume	
Accompaniment Volume	8, 16, 18
Bass Drum Volume	16, 52
Click Volume	8, 16, 18
Cymbal Volume	52
Drum Kit volume	47
Drum Voice Volume	41
Master Volume	8, 16, 18
MIDI Transmit Volume	46
Other Drum Instrument Volume	52
Snare Drum Volume	16, 52
Song Volume	18
TG (Tone Generator) Volume	58, 60
User Song Volume	49
Volume Mode	52

DRUMKIT BLANK CHART

Drumkit Name _____

Rev Type	Rev Time	Rev Master Return	Volume	Rev Send	HH Sens	Song Sel	Tempo Sel
----------	----------	-------------------	--------	----------	---------	----------	-----------

Category	Voice No.	Volume	Pan	Tune C	Tune F	Layer Balance	Decay	Filter	Note No.	Channel	Gate Time	X Fade	Rev Send	Alt Group	Key Assign	Hold Mode	Keyoff	Function	Song No.	Song Repeat	Song Mode	Rim to Pad	
pad1																							
rim1																							
pad2																							
rim2																							
pad3																							
rim3																							
pad4																							
rim4																							
pad5																							
rim5																							
pad6																							
rim6																							
pad7																							
rim7																							
open																							
rimOpen																							
close																							
rimClose																							
footClose																							
splash																							
pad9																							
pad10																							

TRIGGER SETUP BLANK CHART

Setup Name _____

Inc	Dec	Input Excong
-----	-----	--------------

Type	Gain	Min Vel	VelCurve	SelfRej	Rejection	Spec.Rej In	SPEC.Rej Level
IN 1							
IN 2							
IN 3							
IN 4							
IN 5							
IN 6							
IN 7							
IN 8							
IN 9							
IN 10							

Channel	sw	pc	msb	lsb	vol	pan
1						
2						
3						
4						
5						
6						
7						
8						
9						
10						
11						
12						
13						
14						
15						
16						

For details of products, please contact your nearest Yamaha or the authorized distributor listed below.

Pour plus de détails sur les produits, veuillez-vous adresser à Yamaha ou au distributeur le plus proche de vous figurant dans la liste suivante.

Die Einzelheiten zu Produkten sind bei Ihrer unten aufgeführten Niederlassung und bei Yamaha Vertragshändlern in den jeweiligen Bestimmungsländern erhältlich.

Para detalles sobre productos, contacte su tienda Yamaha más cercana o el distribuidor autorizado que se lista debajo.

Per dettagli concernenti i prodotti, si prega di contattare il vostro rappresentante Yamaha più vicino o il distributore autorizzato indicato sotto.

Neem voor meer productinformatie contact op met uw dichtstbijzijnde Yamaha-dealer of de onderstaande officiële distributeur.

NORTH AMERICA

CANADA

Yamaha Canada Music Ltd.
135 Milner Avenue, Scarborough, Ontario,
M1S 3R1, Canada
Tel: 416-298-1311

U.S.A.

Yamaha Corporation of America
6600 Orangethorpe Ave., Buena Park, Calif. 90620,
U.S.A.
Tel: 714-522-9011

CENTRAL & SOUTH AMERICA

MEXICO

**Yamaha de Mexico S.A. De C.V.,
Departamento de ventas**
Javier Rojo Gomez No.1149, Col. Gpe Del
Moral, Deleg. Iztapalapa, 09300 Mexico, D.F.
Tel: 686-00-33

BRAZIL

Yamaha Musical do Brasil LTDA.
Av. Rebouças 2636, São Paulo, Brasil
Tel: 011-853-1377

ARGENTINA

Yamaha Music Argentina S.A.
Viamonte 1145 Piso2-B 1053,
Buenos Aires, Argentina
Tel: 1-371-7021

PANAMA AND OTHER LATIN AMERICAN COUNTRIES/ CARIBBEAN COUNTRIES

Yamaha de Panama S.A.
Torre Banco General, Piso 7, Urbanización Marbella,
Calle 47 y Aquilino de la Guardia,
Ciudad de Panamá, Panamá
Tel: 507-269-5311

EUROPE

THE UNITED KINGDOM

Yamaha-Kemble Music (U.K.) Ltd.
Sherbourne Drive, Tilbrook, Milton Keynes,
MK7 8BL, England
Tel: 01908-366700

IRELAND

Danfay Ltd.
61D, Sallynoggin Road, Dun Laoghaire, Co. Dublin
Tel: 01-2859177

GERMANY/SWITZERLAND

Yamaha Europa GmbH.
Siemensstraße 22-34, 25462 Rellingen,
F.R. of Germany
Tel: 04101-3030

AUSTRIA

Yamaha Music Austria
Schleiergasse 20, A-1100 Wien Austria
Tel: 01-60203900

THE NETHERLANDS

Yamaha Music Nederland
Kanaalweg 18G, 3526KL, Utrecht, The Netherlands
Tel: 030-2828411

BELGIUM

Yamaha Music Belgium
Keiberg Imperiastraat 8, 1930 Zaventem, Belgium
Tel: 02-7258220

FRANCE

**Yamaha Musique France,
Division Professionnelle**
BP 70-77312 Marne-la-Vallée Cedex 2, France
Tel: 01-64-61-4000

ITALY

**Yamaha Musica Italia S.P.A.,
Combo Division**
Viale Italia 88, 20020 Lainate (Milano), Italy
Tel: 02-935-771

SPAIN/PORTUGAL

Yamaha-Hazen Electronica Musical, S.A.
Jorge Juan 30, 28001, Madrid, Spain
Tel: 91-577-7270

GREECE

Philippe Nakas S.A.
Navarinou Street 13, P.Code 10680, Athens, Greece
Tel: 01-364-7111

SWEDEN

Yamaha Scandinavia AB
J. A. Wettergrens Gata 1
Box 30053
S-400 43 Göteborg, Sweden
Tel: 031 89 34 00

DENMARK

YS Copenhagen Liaison Office
Generatorvej 8B
DK-2730 Herlev, Denmark
Tel: 44 92 49 00

FINLAND

F-Musiikki Oy
Kluuvikatu 6, P.O. Box 260,
SF-00101 Helsinki, Finland
Tel: 09 618511

NORWAY

Norsk filial av Yamaha Scandinavia AB
Grini Næringspark 1
N-1345 Østerås, Norway
Tel: 67 16 77 70

ICELAND

Skifan HF
Skeifan 17 P.O. Box 8120
IS-128 Reykjavik, Iceland
Tel: 525 5000

OTHER EUROPEAN COUNTRIES

Yamaha Europa GmbH.
Siemensstraße 22-34, 25462 Rellingen, F.R. of
Germany
Tel: 04101-3030

AFRICA

**Yamaha Corporation,
International Marketing Division**
Nakazawa-cho 10-1, Hamamatsu, Japan 430-8650
Tel: 053-460-2312

MIDDLE EAST

TURKEY/CYPRUS

Yamaha Europa GmbH.
Siemensstraße 22-34, 25462 Rellingen,
F.R. of Germany
Tel: 04101-3030

OTHER COUNTRIES

**Yamaha Corporation,
International Marketing Division**
Nakazawa-cho 10-1, Hamamatsu, Japan 430-8650
Tel: 053-460-2312

ASIA

HONG KONG

Tom Lee Music Co., Ltd.
11/F., Silvercord Tower 1, 30 Canton Road,
Tsimshatsui, Kowloon, Hong Kong
Tel: 2737-7688

INDONESIA

**PT. Yamaha Music Indonesia (Distributor)
PT. Nusantik**
Gedung Yamaha Music Center, Jalan Jend. Gatot
Subroto Kav. 4, Jakarta 12930, Indonesia
Tel: 21-520-2577

KOREA

Cosmos Corporation
#131-31, Neung-Dong, Sungdong-Ku, Seoul
Korea
Tel: 02-466-0021~5

MALAYSIA

Yamaha Music Malaysia, Sdn., Bhd.
Lot 8, Jalan Perbandaran, 47301 Kelana Jaya,
Petaling Jaya, Selangor, Malaysia
Tel: 3-703-0900

PHILIPPINES

Yupangco Music Corporation
339 Gil J. Puyat Avenue, P.O. Box 885 MCPO,
Makati, Metro Manila, Philippines
Tel: 819-7551

SINGAPORE

Yamaha Music Asia Pte., Ltd.
Blk 202 Hougang, Street 21 #02-01,
Singapore 530202
Tel: 747-4374

TAIWAN

Yamaha KHS Music Co., Ltd.
10F, 150, Tun-Hwa Northroad,
Taipei, Taiwan, R.O.C.
Tel: 02-2713-8999

THAILAND

Siam Music Yamaha Co., Ltd.
121/60-61 RS Tower 17th Floor,
Ratchadaphisek RD., Dindaeng,
Bangkok 10320, Thailand
Tel: 02-641-2951

THE PEOPLE'S REPUBLIC OF CHINA AND OTHER ASIAN COUNTRIES

**Yamaha Corporation,
International Marketing Division**
Nakazawa-cho 10-1, Hamamatsu, Japan 430-8650
Tel: 053-460-2317

OCEANIA

AUSTRALIA

Yamaha Music Australia Pty. Ltd.
17-33 Market Street, South Melbourne, Vic. 3205,
Australia
Tel: 3-699-2388

NEW ZEALAND

Music Houses of N.Z. Ltd.
146/148 Captain Springs Road, Te Papapa,
Auckland, New Zealand
Tel: 9-634-0099

COUNTRIES AND TRUST TERRITORIES IN PACIFIC OCEAN

**Yamaha Corporation,
International Marketing Division**
Nakazawa-cho 10-1, Hamamatsu, Japan 430-8650
Tel: 053-460-2317

FCC INFORMATION (U.S.A.)

1. IMPORTANT NOTICE: DO NOT MODIFY THIS UNIT!

This product, when installed as indicated in the instructions contained in this manual, meets FCC requirements. Modifications not expressly approved by Yamaha may void your authority, granted by the FCC, to use the product.

2. IMPORTANT:

When connecting this product to accessories and/or another product use only high quality shielded cables. Cable/s supplied with this product MUST be used. Follow all installation instructions. Failure to follow instructions could void your FCC authorization to use this product in the USA.

3. NOTE:

This product has been tested and found to comply with the requirements listed in FCC Regulations, Part 15 for Class "B" digital devices. Compliance with these requirements provides a reasonable level of assurance that your use of this product in a residential environment will not result in harmful interference with other electronic devices. This equipment generates/uses radio frequencies and, if not installed and used according to the instructions found in the users manual, may cause interference harmful to the operation of other electronic devices. Compliance with FCC

regulations does not guarantee that interference will not occur in all installations. If this product is found to be the source of interference, which can be determined by turning the unit "OFF" and "ON", please try to eliminate the problem by using one of the following measures:

Relocate either this product or the device that is being affected by the interference.

Utilize power outlets that are on different branch (circuit breaker or fuse) circuits or install AC line filter/s.

In the case of radio or TV interference, relocate/reorient the antenna. If the antenna lead-in is 300 ohm ribbon lead, change the lead-in to co-axial type cable.

If these corrective measures do not produce satisfactory results, please contact the local retailer authorized to distribute this type of product. If you can not locate the appropriate retailer, please contact Yamaha Corporation of America, Electronic Service Division, 6600 Orangethorpe Ave, Buena Park, CA90620

The above statements apply ONLY to those products distributed by Yamaha Corporation of America or its subsidiaries.

* This applies only to products distributed by YAMAHA CORPORATION OF AMERICA.

(class B)

