



RM-W Firmware Update Instructions

■ Summary

After pairing the microphone whose firmware operator wants to update with the access point, update the microphone firmware over-the-air to the microphone, which is contained in the access point firmware.

- [1] Log in to the Web-GUI of the access point using "RM Device Finder"
- [2] Pair the access point and microphone
- [3] Update microphone firmware from Web-GUI
- [4] Unpair the access point and microphone

■ Advanced Requirements

- 1 x Windows PC with wired ethernet connector
- 1 x PoE network switch
- LAN cable (CAT5e or higher)
- PC application "RM Device Finder"
- RM-WAP-8 (uploaded new firmware)

[Procedure for Logging in the Access Point's Web-GUI]

1. Execute RM Device Finder.exe and search for access points.

Double-clicking the Web-GUI icon of the access point to be paired with the microphone from the listed access points displays the Web-GUI login screen. In that case, please confirm that the version of the access point is 1.8.2.

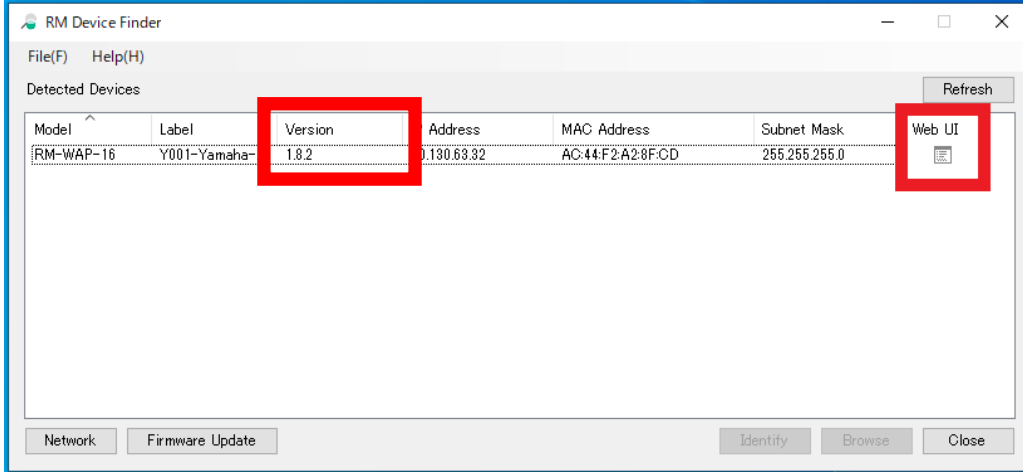

2. Set the Web-GUI login password.

Operator will need to set a password when logging in for the first time.

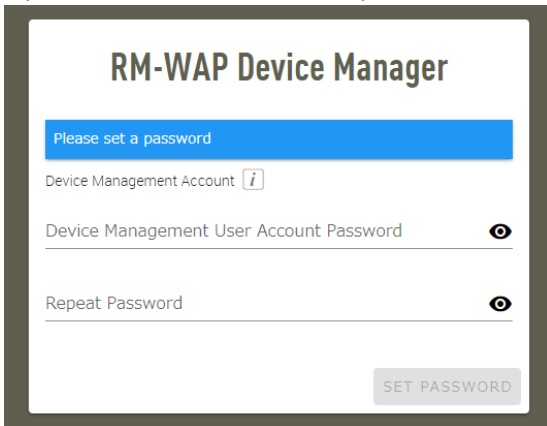

3. Login to Web-GUI.

After setting the password, log in using the set password.

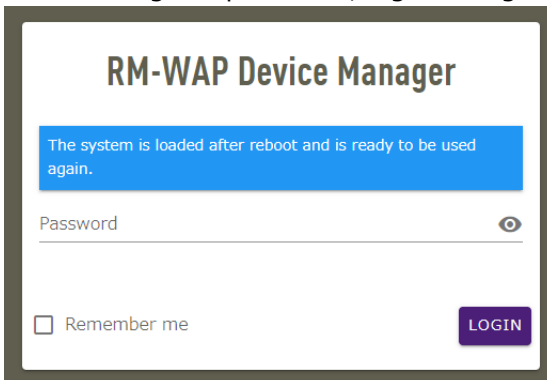

【Pairing Procedure】

1. Click the “PAIR NEW” button on the SETTINGS>MICROPHONE page.

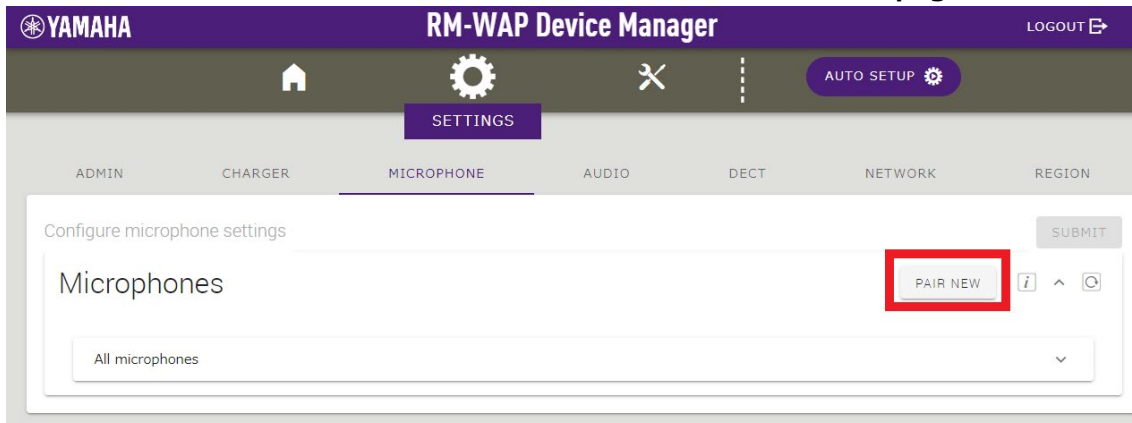

The access point will wait for pairing from the microphone. At this time, the status indicator of the access point itself blinks blue.

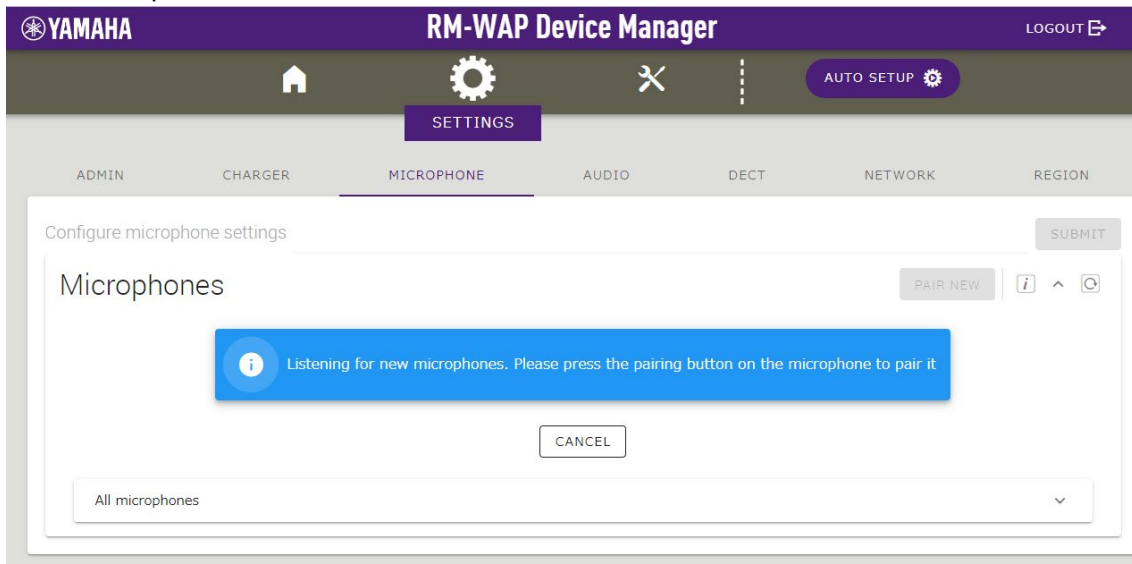

2. Press and hold the “PAIR” button for more than 2 seconds after activating the microphone.

The Mic indicator on the microphone will blink in blue rapidly to initiate pairing. When pairing is completed, it will blink twice in blue slowly and return to its original state.

【底面】

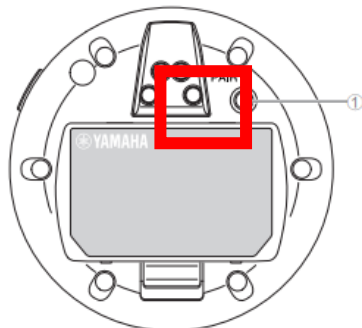

① PAIR ボタン

操作	Mic インジケータ	本製品の状態
PAIR ボタンを 2 秒以上長押しする	青色に高速で点滅	ペアリング待機状態 / ペアリングしている途中
PAIR ボタンを 2 秒以上長押しする	(青色に高速で点滅したあとに) 青色に 2 回点滅	ペアリングに成功した
PAIR ボタンを 2 秒以上長押しする	(青色に高速で点滅したあとに) 赤色に 2 回点滅	ペアリングに失敗した

3. Once pairing is completed, the microphone will be listed.

✓ indicates the updated state, 🔄 indicates that an update is required.

If pairing fails or if the pairing waiting state is canceled (pairing was not completed within 120 seconds), proceed to step 1. Please start over.

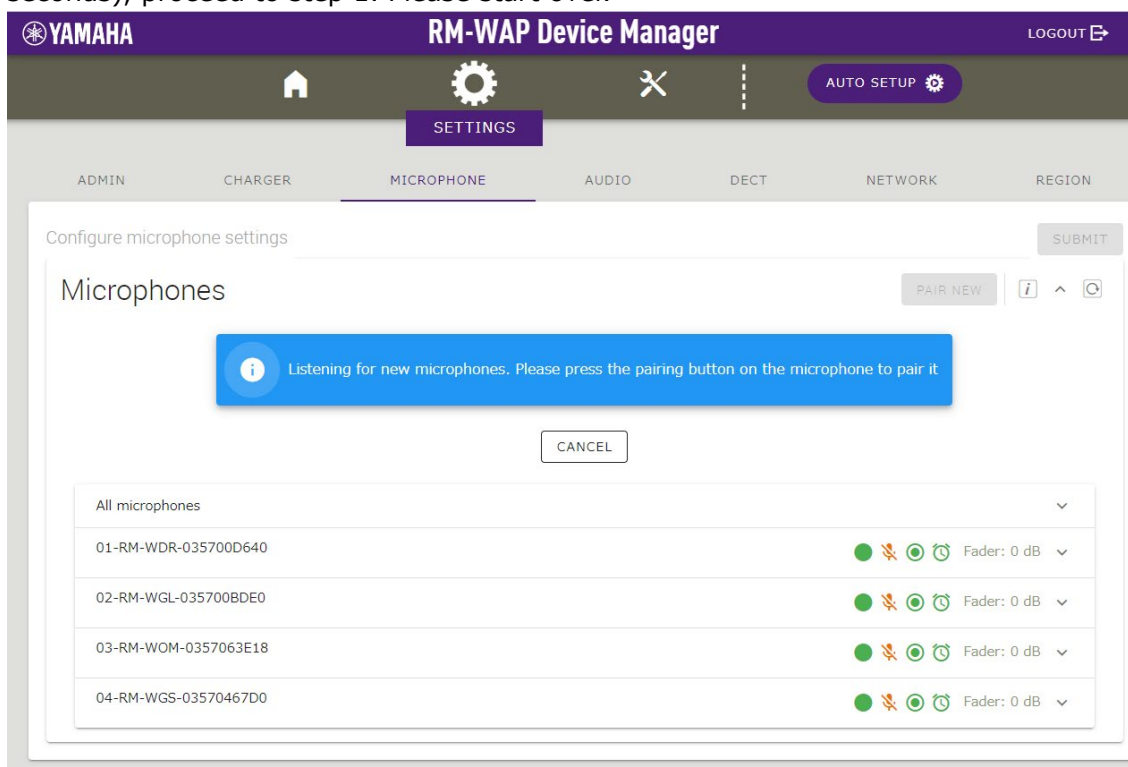

4. Click the "CANCEL" button on the SETTINGS>MICROPHONE page.

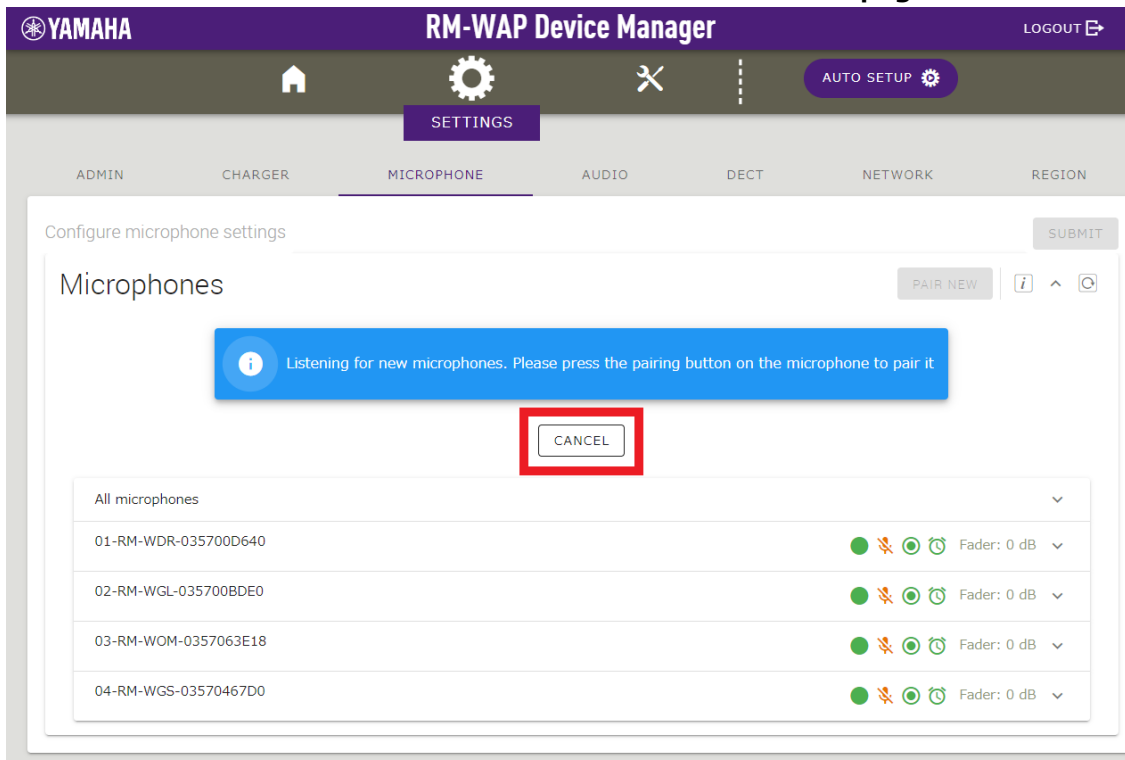

Pairing is now completed.

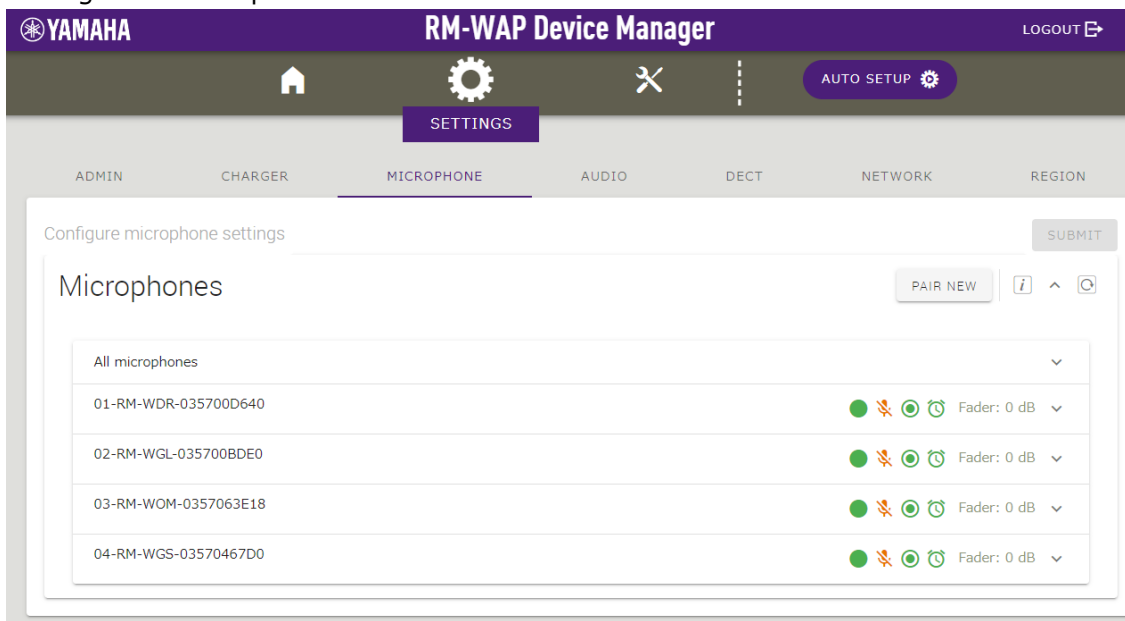

[Firmware Update Procedure]

1. Click the "TURN ON FWU MODE" button on the TOOLS>UPDATE page.

Click this button to change to firmware update only mode and stop audio communication between the Access point and the microphone. When the firmware update is completed, click the "TURN OFF FWU MODE" button to release the dedicated mode.

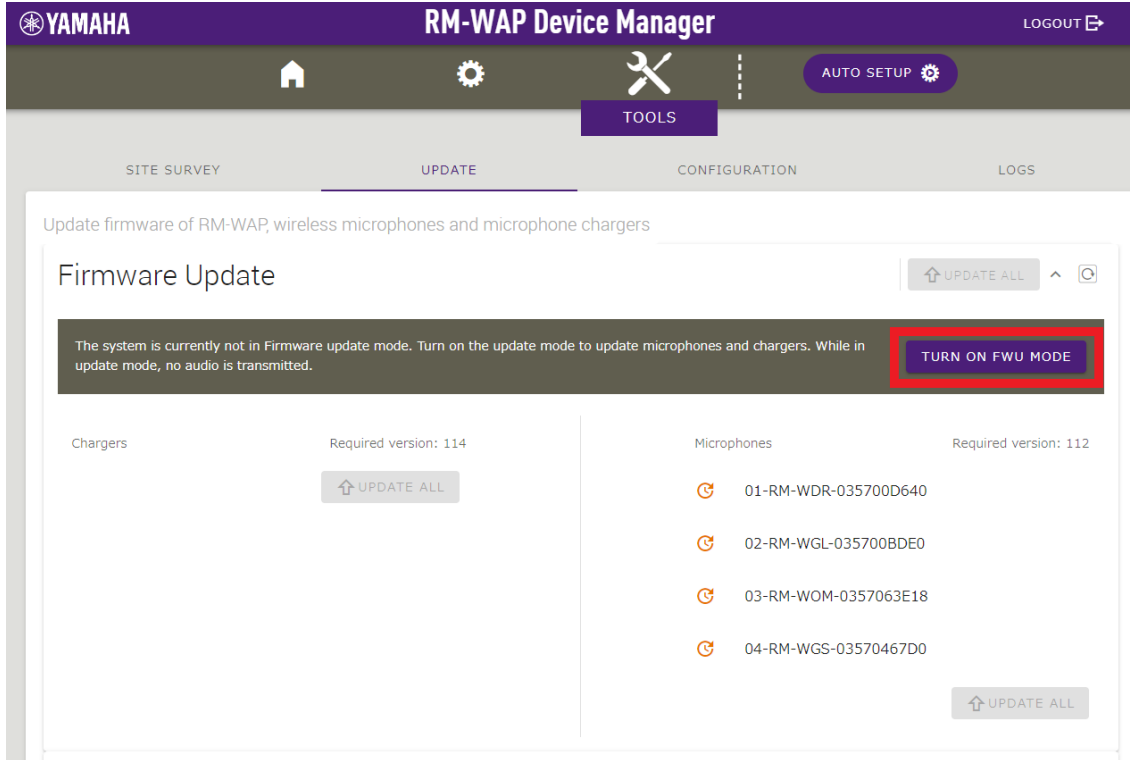

2. Click the "UPDATE ALL" button.

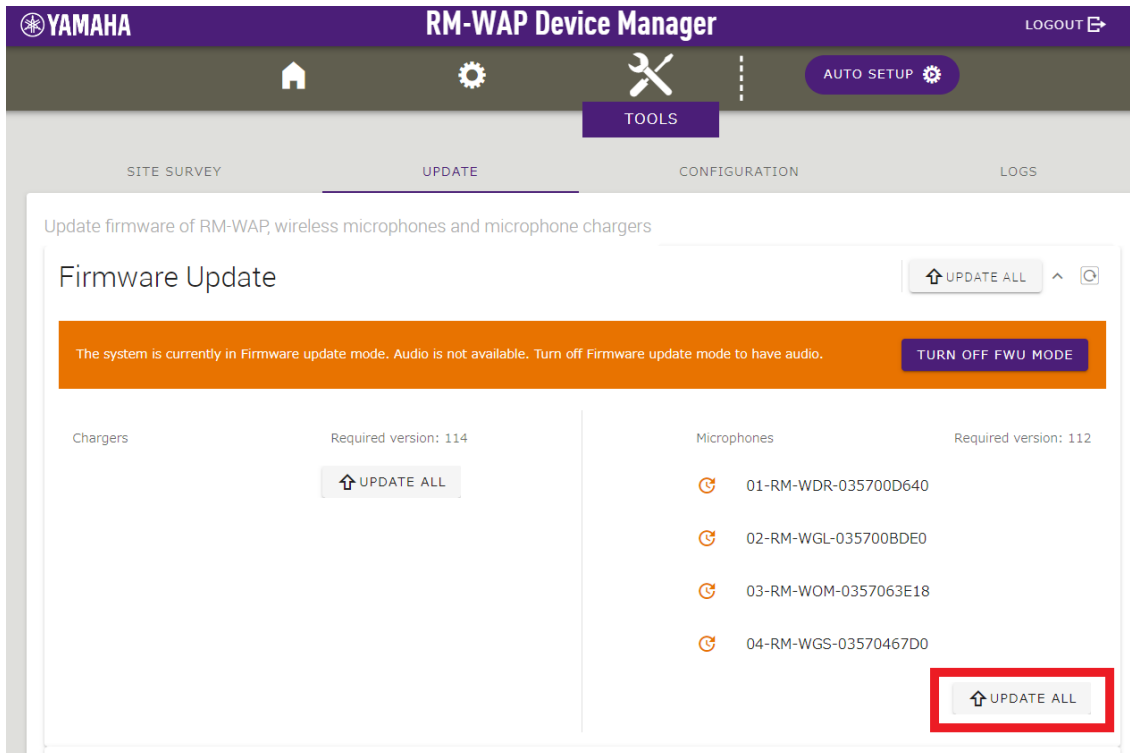

The microphone update will start. Only microphones that require an update will be updated. The update is executed one by one and takes about 3 minutes per device.

YAMAHA RM-WAP Device Manager

LOGOUT

SITE SURVEY UPDATE CONFIGURATION LOGS

Update firmware of RM-WAP, wireless microphones and microphone chargers

Firmware Update

UPDATE ALL

The system is currently in Firmware update mode. Audio is not available. Turn off Firmware update mode to have audio. **TURN OFF FWU MODE**

Chargers	Required version: 114	Microphones	Required version: 112
	UPDATE ALL	01-RM-WDR-035700D640	
		02-RM-WGL-035700BDE0	
		03-RM-WOM-0357063E18	
		04-RM-WGS-03570467D0	

UPDATE ALL

The status will change when the update is completed.

YAMAHA RM-WAP Device Manager

LOGOUT

SITE SURVEY UPDATE CONFIGURATION LOGS

Update firmware of RM-WAP, wireless microphones and microphone chargers

Firmware Update

UPDATE ALL

The system is currently in Firmware update mode. Audio is not available. Turn off Firmware update mode to have audio. **TURN OFF FWU MODE**

Chargers	Required version: 114	Microphones	Required version: 112
	UPDATE ALL	✓ 01-RM-WDR-035700D640	
		02-RM-WGL-035700BDE0	
		03-RM-WOM-0357063E18	
		04-RM-WGS-03570467D0	

UPDATE ALL

Operator can check the status of the firmware update on the microphone itself with the Mic indicator.

RM-WOM RM-WDR

[Top panel/side panel]

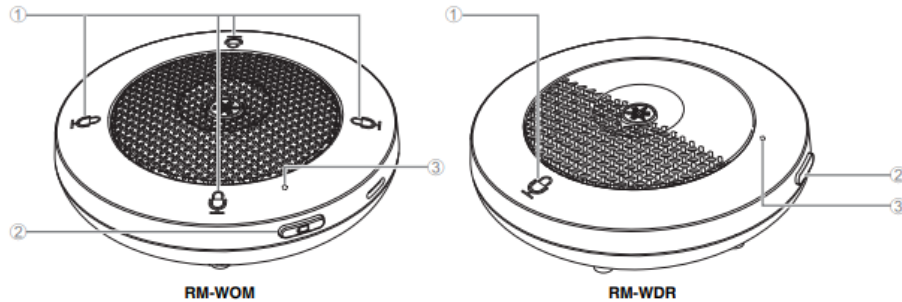

① Mic buttons/indicators

Condition	Mic indicator	Unit status
Mic button touched	Lit green	Microphone on
Mic button touched	Lit red (Flashes every 2 seconds)	Microphone off
Identifying Web GUI status	Flashes white	Resolving (Identification)
Updating firmware	Flashes white quickly	Firmware being updated
Updating firmware	(After flashing white quickly) Flashes white twice	Firmware updated successfully
Updating firmware	(After flashing white quickly) Flashes red twice	Firmware update failed
-	Flashes red quickly	System error occurring
-	Flashes red slowly	Out of range for DECT connection

3. After confirming that the firmware has been updated, click the “TURN OFF FWU MODE” button.

Firmware update is now completed.

YAMAHA RM-WAP Device Manager LOGOUT

SITE SURVEY UPDATE CONFIGURATION LOGS

Update firmware of RM-WAP, wireless microphones and microphone chargers

Firmware Update

↑ UPDATE ALL

The system is currently not in Firmware update mode. Turn on the update mode to update microphones and chargers. While in update mode, no audio is transmitted. **TURN ON FWU MODE**

Chargers	Required version: 114	Microphones	Required version: 112
	↑ UPDATE ALL	✓ 01-RM-WDR-035700D640	
		✓ 02-RM-WGL-035700BDE0	
		✓ 03-RM-WOM-0357063E18	
		✓ 04-RM-WGS-03570467D0	
			↑ UPDATE ALL

[Unpairing Procedure]

1. Click all “” icon of All microphone tab on the SETTINGS>MICROPHONE page.
Unpair all paired microphones for the next microphone firmware update.

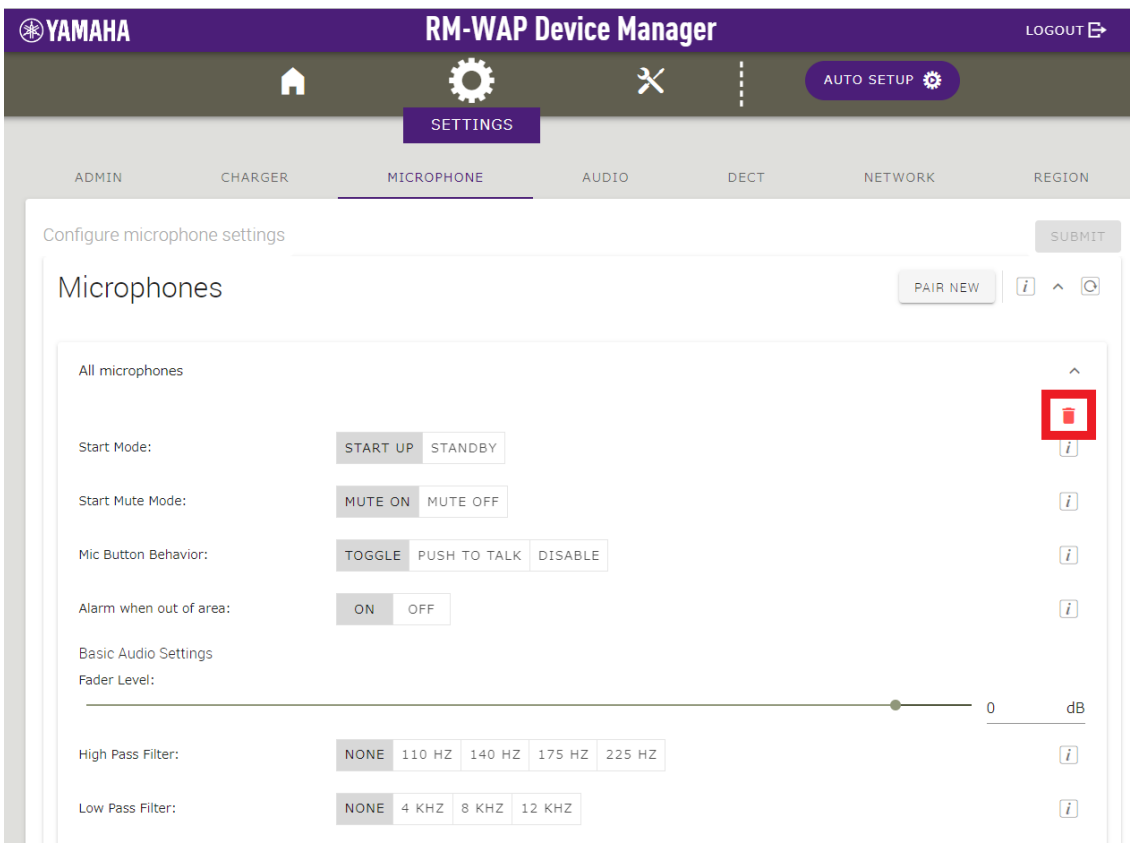
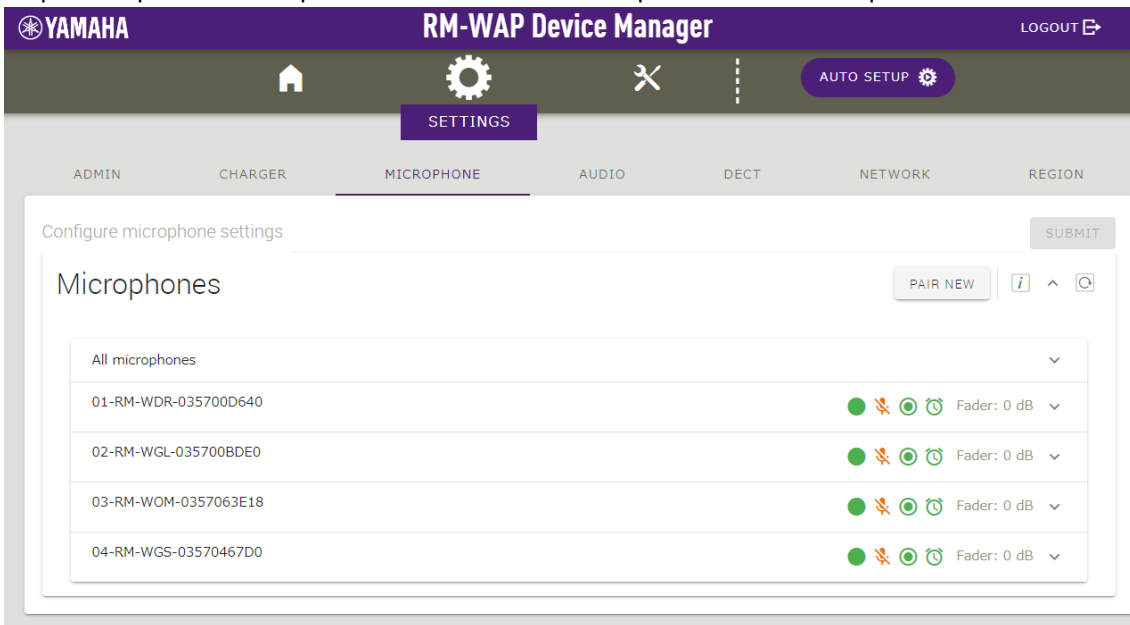

Unpairing is completed when all microphone names are removed from the list.

