

YAMAHA DIGITAL EQUALIZER

DEQ5E

OPERATION MANUAL

MANUAL D'UTILISATION

BEDIENUNGSANLEITUNG

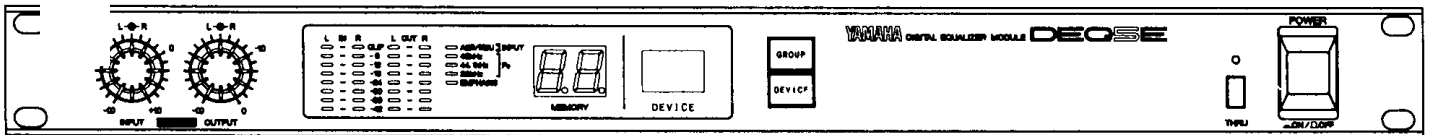

FCC INFORMATION (U.S.A.)

1. IMPORTANT NOTICE: DO NOT MODIFY THIS UNIT!

This product, when installed as indicated in the instructions contained in this manual, meets FCC requirements. Modifications not expressly approved by Yamaha may void your authority, granted by the FCC, to use the product.

2. IMPORTANT: When connecting this product to accessories and/or another product use only high quality shielded cables. Cable/s supplied with this product MUST be used. Follow all installation instructions. Failure to follow instructions could void your FCC authorization to use this product in the USA.

3. NOTE: This product has been tested and found to comply with the requirements listed in FCC Regulations, Part 15 for Class "B" digital devices. Compliance with these requirements provides a reasonable level of assurance that your use of this product in a residential environment will not result in harmful interference with other electronic devices. This equipment generates/uses radio frequencies and, if not installed and used according to the instructions found in the users manual, may cause interference harmful to the operation of other electronic devices. Compliance with FCC regulations does not guarantee that interference will not occur in all installations. If this product is found to be the source of interference, which can be determined by turning the unit "OFF" and "ON", please try to eliminate the problem by using one of the following measures:

Relocate either this product or the device that is being affected by the interference.

Utilize power outlets that are on different branch (circuit breaker or fuse) circuits or install AC line filter/s.

In the case of radio or TV interference, relocate/reorient the antenna. If the antenna lead-in is 300 ohm ribbon lead, change the lead-in to co-axial type cable.

If these corrective measures do not produce satisfactory results, please contact the local retailer authorized to distribute this type of product. If you can not locate the appropriate retailer, please contact Yamaha Corporation of America, Electronic Service Division, 6600 Orangethorpe Ave, Buena Park, CA 90620

* This applies only to products distributed by YAMAHA CORPORATION OF AMERICA.

CANADA

THIS DIGITAL APPARATUS DOES NOT EXCEED THE "CLASS B" LIMITS FOR RADIO NOISE EMISSIONS FROM DIGITAL APPARATUS SET OUT IN THE RADIO INTERFERENCE REGULATION OF THE CANADIAN DEPARTMENT OF COMMUNICATIONS.

LE PRESENT APPAREIL NUMERIQUE N'EMET PAS DE BRUITS RADIOELECTRIQUES DEPASSANT LES LIMITES APPLICABLES AUX APPAREILS NUMERIQUES DE LA "CLASSE B" PRESCRITES DANS LE REGLEMENT SUR LE BROUILLAGE RADIOELECTRIQUE EDICTE PAR LE MINISTRE DES COMMUNICATIONS DU CANADA.

* This applies only to products distributed by YAMAHA CANADA MUSIC LTD.

IMPORTANT NOTICE FOR THE UNITED KINGDOM

Connecting the Plug and Cord

WARNING: THIS APPARATUS MUST BE EARTHED

IMPORTANT: The wires in this mains lead are coloured in accordance with the following code:

GREEN-AND-YELLOW : EARTH
BLUE : NEUTRAL
BROWN : LIVE

As the colours of the wires in the mains lead of this apparatus may not correspond with the coloured markings identifying the terminals in your plug proceed as follows:

The wire which is coloured BLUE must be connected to the terminal which is marked with the letter N or coloured BLACK.

The wire which is coloured GREEN-AND-YELLOW must be connected to the terminal in the plug which is marked by the letter E or by the safety earth symbol \perp or coloured GREEN or GREEN-AND-YELLOW.

The wire which is coloured BROWN must be connected to the terminal which is marked with the letter L or coloured RED.

Making sure that neither core is connected to the earth terminal of the three pin plug.

* This applies only to products distributed by YAMAHA - KEMBLE MUSIC (U.K.) LTD.

Dette apparat overholder det gaeldende EF-direktiv vedrørende radiostøj.

Cet appareil est conforme aux prescriptions de la directive communautaire 87/308/CEE.

Diese Geräte entsprechen der EG-Richtlinie 82/499/EWG und/oder 87/308/EWG.

This product complies with the radio frequency interference requirements of the Council Directive 82/499/EEC and/or 87/308/EEC.

Questo apparecchio è conforme al D.M.13 aprile 1989 (Direttiva CEE/87/308) sulla soppressione dei radio-disturbi.

Este producto está de acuerdo con los requisitos sobre interferencias de radio frecuencia fijados por el Consejo Directivo 87/308/CEE.

YAMAHA CORPORATION

YAMAHA DIGITAL EQUALIZER
DEQ5E

OPERATION MANUAL

Thank you ... for purchasing the digital equalizer DEQ5E. In order to take full advantage of all the DEQ5E's advanced features and capabilities we urge you to read this operation manual thoroughly before using the DEQ5E. Be sure to store the manual in a safe place when you finish.

The main operations of the DEQ5E are reliant upon on the DEQ5 (or an equivalent personal computer).

When no contents regarding equalizing operations or utility settings are specified, these two items are controlled by DEQ5's remote control operation.

Before you read the manual

- ◆ The "DEQ5(E)" in this manual refers to DEQ5 or DEQ5E.
- ◆ For convenience, the software functions explained in this document (such as Mode, Menu, and Parameter) use the same nomenclature as DEQ5.

Accessories

This DEQ5E package contains the following items.

- DEQ5E main unit
- Operation manual

Outline and features of the DEQ5E

◆ Features of the operation panel

This unit, except for a few specific functions, has no controls or switches for operating the various parameters inside the main unit.

◆ High functionality is made into compact size

Because this unit's various operations and settings are reliant upon external devices, a minimum of operational keys, displays, and controls are provided. This results in 1U compact size.

◆ Two equalizer modes

Two main equalizer modes are incorporated: the 30-band $\pm 15\text{dB}$ variable graphic equalizer mode (GEQ mode), and a 6-band $\pm 15\text{dB}$ variable parametric equalizer mode (PEQ mode).

Remote control is enabled from a personal computer

This unit's parameters can be controlled on a personal computer. Do this by connecting the DEQ5(E) to a personal computer with an RS-485 interface, and using DEQ5(E) control software.

◆ 2-channel stereo specifications

The equalizer section is capable of handling 2-channel stereo. The basic specifications of the equalizer section, with a few exceptions, are the same as the DEQ5.

Each parameter can separately or simultaneously control the left and right channels (parameter link).

◆ **High performance A/D and D/A conversion section which contributes to high class sound quality**

A 19-bit conversion process is used in the A/D conversion section, while a 20-bit conversion process is used in the D/A conversion section. This makes a dynamic range of 110dB or more possible (analog input when EMPHASIS is on) and contributes to higher sound quality reproduction.

◆ **Independent digital delay built in for each channel**

In addition to the equalizer function, a digital delay (used for phase compensation) is independently built into each channel.

◆ **Built-in hum filter**

A hum filter has been incorporated into the unit to eliminate hum and harmonics generated by the power supply transformer.

◆ **40-program user memory**

Up to 40 programs of created equalizer data can be stored in the user memory, when either PEQ or GEQ data is used.

(Refer to "Memory configuration" on page 8 for details.)

Data stored in memory can be transmitted or received through the RS-485 terminal with the following devices.

- Another DEQ5 or DEQ5E (*1)
- A personal computer which incorporates a RS-485 interface and the DEQ5(E) start-up control software.
- A personal computer with a MIDI interface and DEQ5(E) start-up control software. (*2)

*1 To transmit or receive data with another DEQ5(E), a DEQ5 (or equivalent personal computer) is required.

*2 One DEQ5 is required to carry out this method. (Use DEQ5 RS-485 ↔ MIDI interface function. Refer to page 24 for details.)

◆ **AES/EBU format digital I/O terminals are installed**

In addition to the XLR type analog I/O terminals, which are commonly used in professional applications, digital I/O terminals for AES/EBU format are also installed.

This kind of digital I/O terminal makes it easier to combine the unit with systems that transmit audio signals in the digital range.

◆ **RS-485 control bus**

The RS-485 control bus is a bus type communication standard which is used for both transmission and reception. Employing this communication standard has the following advantages:

- Expands the system by allowing a maximum of 23 additional DEQ5(E)s to be connected in serial, with one DEQ5 functioning as a control master. A maximum of 217 DEQ5 or DEQ5E units can be controlled by a personal computer.
- Wide range installation is enabled, with a maximum of several hundred meters of long distance communication connections.
- The RS-485 terminal employs a XLR type connector system. Therefore, control data can be transmitted or received with the cable for XLR type connector systems (*1).

Refer to page 25 explaining "RS-485" for details regarding the communication standard.

*1 Use a cable with impedance characteristics between 90 and 120Ω to prevent signal deterioration during RS-485 data transmission (especially for long distance transmissions).

TABLE OF CONTENTS

1 BEFORE USE	1	(5) RS485 communication I/O	15
1. Before use	1	(6) Parameter copy	16
(1) Precautions	1	(7) Software protect	17
(2) Precautions regarding rack mounting	1	(8) RS-485 Program Change table	17
(3) Power supply	1		
(4) Connection	1	4 REMOTE CONTROL BY DEQ5	18
(5) Pin assignment of the analog I/O XLR terminal	1	1. Concept of Remote Control	18
(6) Memory back-up	2	2. Remote Assign Setting	20
(7) Maintenance	2	3. Local Address Setting	20
2. Local address setting	2	4. Connection	22
3. Handling the digital audio input signal	3	5 CONTROL BY A COMPUTER	23
(1) Input setting	3	1. Control using RS-485 terminal	23
(2) Handling the clock signal	3	2. Control using MIDI (RS-485 circuit via DEQ5)	24
2 NOMENCLATURE AND FUNCTIONS	4	6 RS-485	25
1. Front panel	4	1. RS-485	25
2. Rear panel	6	2. Connection	26
		3. Communication bus standard	27
3 SOFTWARE FOR THE DEQ5E	8	4. Definition of address	28
1. Memory configuration	8	(1) Local address	28
(1) Memory area	8	(2) Remote address	28
(2) Edit area	8	(3) Group number and Device number	28
(3) Initial data area	8	(4) Broadcast address	28
2. Parameters	9	5. What is possible with RS485	31
(1) Equalizer	9	(1) Parameter Change	31
① Graphic equalizer mode	9	(2) Program Change	31
② Parametric equalizer mode	9	(3) Bulk dump	31
(2) Filter	10	7 SPECIFICATIONS	32
(3) Hum filter	10		
(4) Digital Delay/Polarity (Phase inversion)	10	Block diagram	34
(5) Attenuator	11		
3. UTILITY	12	Dimensional drawing	35
(1) System setup	12		
(2) Title edit	13		
(3) Bulk dump	15		
(4) RS485 network	15		

1 BEFORE USE

1. Before use

(1) Precautions

- Operating temperature – Use the unit in an environment with an ambient temperature of 10 to 35°C.
- Avoid exposing the unit to direct sunlight for long periods of time.
When using it outdoors, place the unit in the shade.
Avoid placing the unit near heaters, stoves, or other heat sources.
- Avoid environments which are subject to excessive dust.
- Avoid environments which are subject to excessive vibration.
- Do not forcibly bend or pull the power supply cord or cables.
- Avoid physical shocks to the operation keys and terminals.
- Since the DEQ5 contains digital circuitry, it may cause interference or noise if placed too close to TV sets or radios. Place them a proper distance away from DEQ5 when using them together.
- If there is a possibility of lightning, turn the power supply off and remove the plug from the outlet, to prevent noise effect from indoor wiring.

(2) Precautions regarding rack mounting

- Avoid mounting the unit on top of equipment which generates substantial amounts of heat, such as a power amplifier.
If you must combine it in the same rack with other devices, keep it at a distance of at least 1U away.
The Yamaha ventilation panel VP1 (sold separately) with ventilation holes, is recommended as a blank panel.

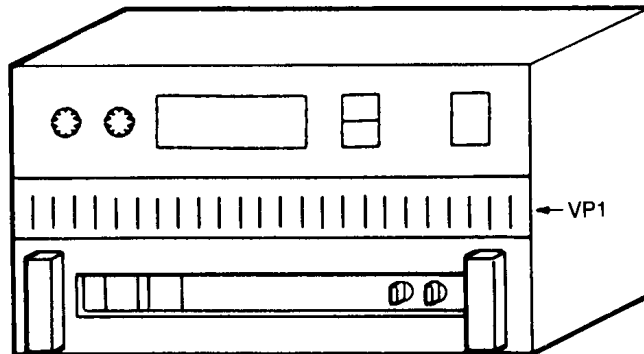

(3) Power supply

- Be sure to use a power source intended for use in normal domestic applications to operate the unit. Do not use any other power source.
- If you do not use the unit for prolonged periods of time, remove the power supply plug from the outlet.

(4) Connection

- Turn down the master volume in the mixer section, or the volume of the power amplifier, when connecting audio cables. Otherwise, noise generated during connection may damage the speakers.

(5) Pin assignment of the analog I/O XLR terminal

- Pin assignment of the analog I/O terminal of the unit is as follows:
No. 1: Ground
No. 2: Hot
No. 3: Cold

(6) Memory back-up

- When the power supply is turned off, settings of all the parameters are retained, due to a back-up battery installed in the unit.

When battery voltage drops, a warning will display when the power supply is turned on.

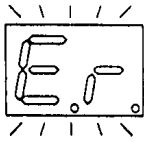

When this warning displays, immediately replace the battery by contacting your nearest Yamaha service center, or the shop from which you purchased your product.

(Note) Since memory contents may be lost when replacing batteries, write down the contents of the settings held in memory on paper, or transfer them to another device by bulk dump.

(7) Maintenance

- Do not use benzene or thinner to clean the exterior of the unit.
- We recommend cleaning the terminal section at regular intervals with a commercially available contact point cleaner. Dirt on the terminal section may cause contact failures.

2. Local address setting

- The local address should be set before using the unit. (Refer to page 20)
- This unit can be only controlled by an external device (DEQ5, personal computer, etc.) through RS-485. To match the unit's communication conditions with those of an external device, the local address (something like telephone number) should be set.
- If multiple devices are connected through RS-485, make sure that no local addresses are identical.

3. Handling the digital audio input signal

(1) Input setting

The unit is provided with a digital system input terminal, except for XLR type analog I/O terminal. When handling signals from this input terminal, change the input system to the appropriate setting on the DEQ5 (or personal computer, etc.) side.

This is done in “SYSTEM SET UP” in the “UTILITY” menu. (*)

* For convenience, the software functions explained in this document (such as Mode, Menu, and Parameter) use the same nomenclature as DEQ5.

(2) Handling the clock signal

When carrying out DEQ5E processing by inputting the digital audio signal to the unit, clock setting is required in the “UTILITY” menu.

It is possible to operate the DEQ5E on the clock signal extracted from the digital audio signal.

However, if all signal transmission and reception is carried out digitally (using the unit as part of the digital audio system), it is better to operate the unit with the clock signal of your digital audio system’s main control unit. Input this clock signal into the “WORD CLK IN” terminal on the unit’s rear panel.

[Example] When the digital mixer is the center of the system

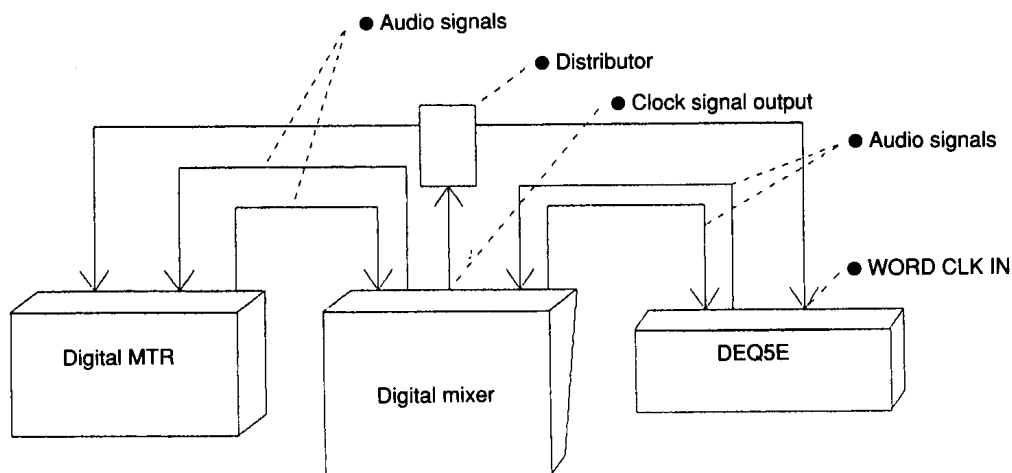

Whether you operate on a signal received from the digital audio signal input, (AES/EBU) or word clock input (WORD CLK IN) is set in the item “CLOCK” in the “UTILITY” “SYSTEM SET UP” menu.

Word clock

All digital audio devices operate based on a specified word clock signal.

This signal determines the operation sampling frequency and the timing when the digital audio signal is transmitted and received.

For the transmission and reception of the digital audio signal between devices, this signal should be synchronized. Otherwise, proper signal transmission and reception is not possible.

Therefore, you must make sure that the word clock signal is synchronized when transmitting or receiving digital audio signal between different devices.

2 NOMENCLATURE AND FUNCTIONS

1. Front panel

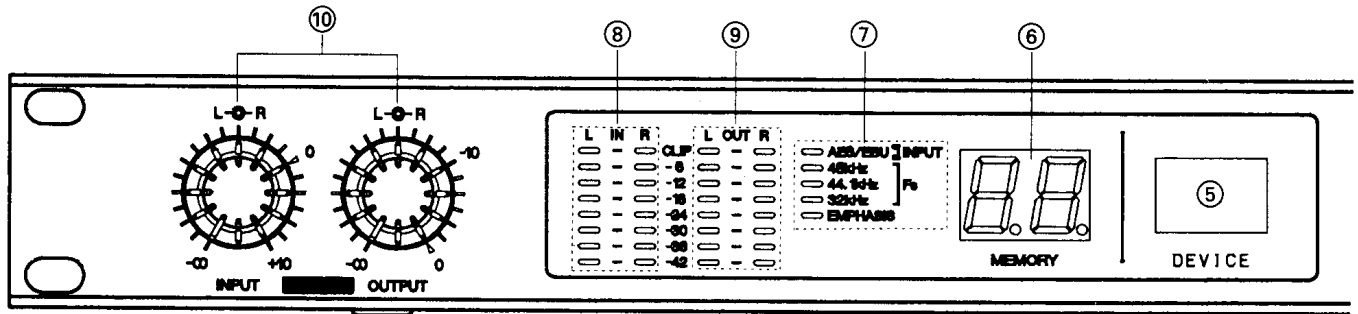

① Power switch

This switch turns the power supply ON/OFF.

Turn on the power supply, and the currently set local address group number is displayed in ⑥ “MEMORY” LED (and flashes for 3 seconds), while the currently set local address device number is displayed in ⑤ “DEVICE” LED.

After this, the memory number and device number recalled prior to turning off the power supply, light up in ⑥ “MEMORY” LED and in ⑤ “DEVICE” LED, respectively.

② THRU switch

Turn on this switch (LED lights up) when directly sending out the input signal in analog from the output terminal. If you turn on this switch when using digital input, the signal cannot be output. (During analog input, the signal is output from both the digital and analog systems.)

③ GROUP key

Use this to set the group number of the unit’s local address when communicating through RS-485. (For the setting method, refer to page 20, 21)

Normally, the “DEVICE” number LED displays the currently set device number. However, pressing the “GROUP” key enables you to check the currently set group number temporarily.

Press the “GROUP” key, and “G” (G) and the group number will display (LED lights up) for 2 seconds, and the device number display will return.

④ DEVICE key

Use this to set the device number of the unit’s local address when communicating through RS-485. (For setting method, refer to page 20, 21) The currently set device number can be checked with ⑤ “DEVICE” LED.

⑤ DEVICE number LED

Normally, the currently set local address device number is displayed. During the setting of ③ and ④ the contents can be checked with this LED.

⑥ MEMORY number LED

The currently recalled memory number is displayed.

When the power supply is turned on, however, the local address group number is displayed temporarily. (Refer to “① Power switch” listed above for details.)



⑦ **Indicators**

The followings indicators show the current system setup status of the unit.

- **INPUT (AES/EBU)**..... This lights when the audio signal is set to AES/EBU digital input side.
- **Fs** Displays the current operation sampling frequency.
 During AES/EBU input terminal digital input, or during operation of the "WORD CLK" terminal clock signal, if the received signal is abnormal (input level is too low or a circuit is broken) or not received properly, all Fs indicators will turn off.
- **EMPHASIS** Indicates whether EMPHASIS processing is completed or not. This lights when EMPHASIS processing is completed.

⑧ **IN level meter**

This displays, digitally, the input signal level after A/D conversion.

⑨ **OUT level meter**

This displays, digitally, output signal level before D/A conversion.

⑩ **Analog I/O adjustment control**

Use the control IN to adjust the analog input level, and use the control OUT to adjust the analog output level. Both controls have two cores, so that balance L can be adjusted by the inside core, and balance R can be adjusted by the outside core.

2. Rear panel

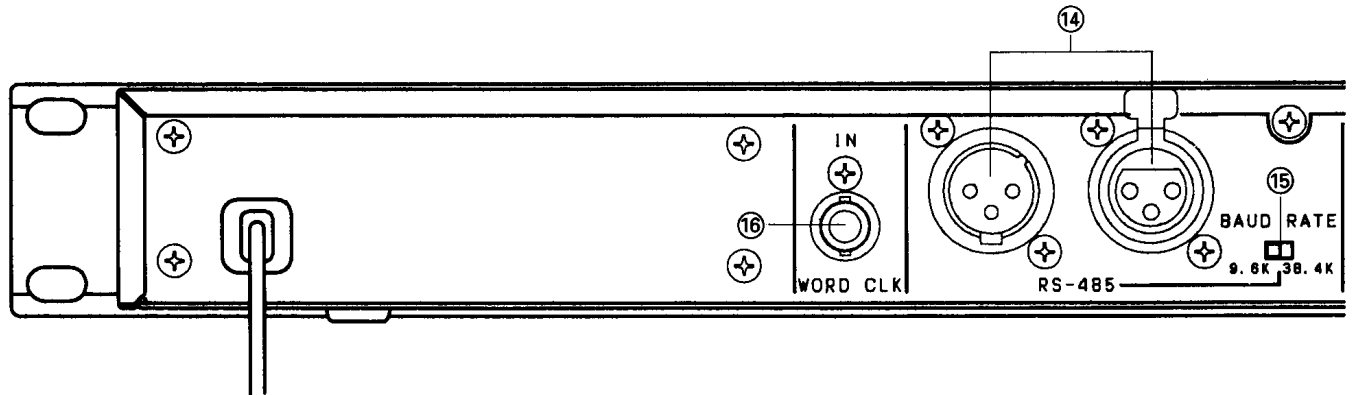

⑪ **ANALOG INPUT terminal**

Input terminal for analog audio signal. Nominal level is +4dBm.

⑫ **ANALOG OUTPUT terminal**

Output terminal for analog sound. Nominal level is +4dBm.

⑬ **AES/EBU DIGITAL I/O terminal**

AES/EBU format digital audio signal I/O terminal.

In order to receive the digital signal of this format, use the “UTILITY” menu to make the appropriate settings.

⑭ **RS-485 terminal**

The unit can transmit or receive various control signals and data in conjunction with DEQ5 (or a personal computer) through this terminal.

To use this terminal, communication conditions should be set on both the controlled unit and the controlling unit. Set baud rate with the ⑮ “BAUD RATE” switch, and set local address on the front panel of the unit.

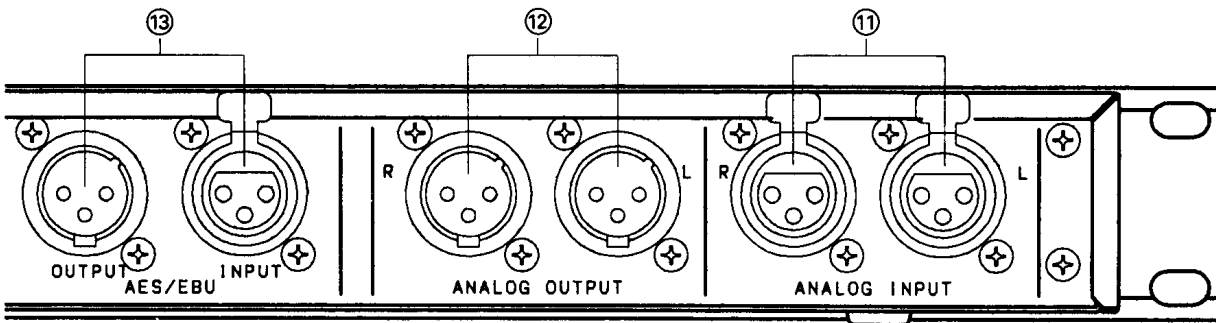

⑮ BAUD RATE select switch

Set baud rate with this switch when communicating with DEQ5 or a personal computer through the RS-485 terminal.

⑯ WORD CLK input terminal

The word clock signal received from the master device is input to this terminal.

During digital audio signal input, inputting the word clock signal received from the master device to this terminal enables more stable operation.

To receive the signal input to this terminal, use the "UTILITY" menu to make the appropriate settings.

When the signal is received properly, the sampling frequency of the received signal is displayed in ⑦ Fs section.

3 SOFTWARE FOR THE DEQ5E

* For convenience, the software functions explained in this document (such as Mode, Menu, and Parameter) use the same nomenclature as DEQ5.

1. Memory configuration

(1) Memory area

The DEQ5E has an area where the equalizer setting data (program) is preserved so that it can be recalled anytime. This is called the “Memory area”.

The DEQ5E has GEQ and PEQ equalizer modes. In the memory area, a maximum of 40 programs can be preserved, no matter which mode they are created in.

When shipped from the factory, initial program data (initial data with flat characteristics) in the two modes are preserved in the memory area, 20 in the first part and another 20 in the second part. (Each 20 have the same contents.)

Two equalizer modes when shipping from the factory

- 30-band graphic equalizer (GEQ) mode Memory number: 1~20
- 6-band parametric equalizer (PEQ) mode ... Memory number: 21~40

(2) Edit area

The area where DEQ5E program is actually executed or data is modified after recalling the data from the memory area is called “Edit area”.

A program using a suitable equalizer mode is recalled from the memory area to the edit area. It can be used as it is, or data can be modified before use.

The new program (after modifying the data in the edit area) is stored in any memory number in the memory area. Re-write Memory as often as you like.

(3) Initial data area

If all programs are made with only one equalizer mode, you can copy initial data of another equalizer mode from “Initial data area” to the edit area with the “PARAMETER COPY” menu in UTILITY.

<DEQ5E memory configuration>

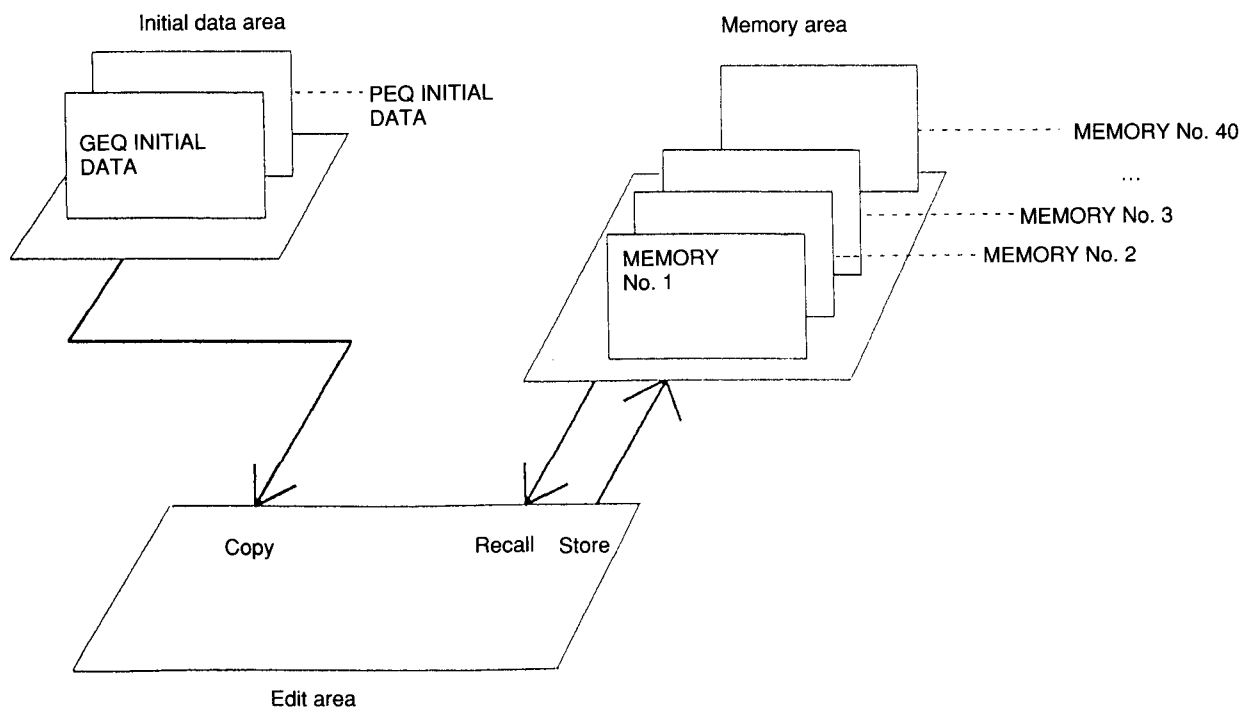

2. Parameters

This section explains the parameters stored in the memory of each program.

(1) Equalizer

For some programs, either equalizer mode can be used. Both modes are stereo specifications, and separate channel setting is possible.

① Graphic equalizer mode

The graphic equalizer mode's equalizer parameter is as follows.

- No. of bands 30 bands
(25, 32, 40, 50, 63, 80, 100, 125, 160, 200, 250, 320, 400, 500, 630, 800, 1.0k, 1.25k, 1.60k, 2.0k, 2.5k, 3.2k, 4.0k, 5.0k, 6.3k, 8.0k, 10.0k, 12.5k, 16.0k, 20.0kHz)
- Gain variable range -15~+15dB (0.5dB step)

<DEQ5 control display example>

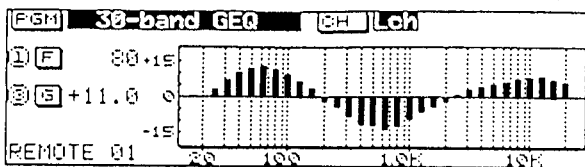

② Parametric equalizer mode

The parametric equalizer mode's equalizer parameter is as follows.

- No. of bands 6 bands
- Frequency variable range

BAND1.....	20~200Hz	(1/24 octave step)
BAND2.....	50~500Hz	(1/24 octave step)
BAND3.....	125~1.25kHz	(1/24 octave step)
BAND4.....	320~3.2kHz	(1/24 octave step)
BAND5.....	800~8.0kHz	(1/24 octave step)
BAND6.....	2.0~20kHz	(1/24 octave step)
- Gain variable range..... -15~+15dB (0.5dB step)
- Q variable range 0.50~10, LSH (BAND 1), HSH (BAND 6)
- Band ON/OFF can be set for each band

<DEQ5 control display example>

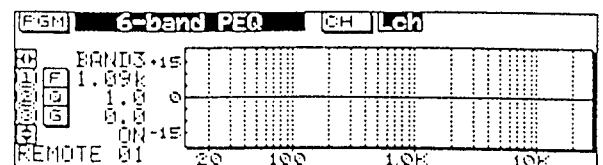
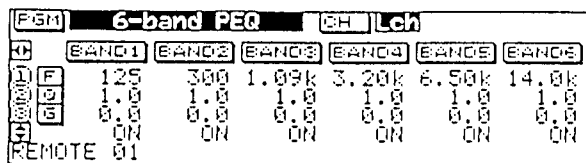

* The parameter may be set while checking the graph of the overall frequency characteristics.

(2) Filter

High pass filter, low pass filter, and notch filter (4 systems) are assigned as a set for each individual channel in either equalizer mode.

A parameter's contents are as follows.

<High pass filter>

- Frequency variable range 20~100Hz (1/24 octave step)
- Slope 24dB/Octave
- Filter ON/OFF Possible

<Notch filter 1~4>

Four notch filters, 1~4, are provided.

The parameters which can be set are common to all four.

- Frequency variable range 20~20kHz (1/24 octave step)
- Q variable range 0.5~10
- Filter ON/OFF Possible for each filter independently

<Low pass filter>

- Frequency variable range 4.0k~20.0kHz (1/24 octave step)
- Slope 24dB/Octave
- Filter ON/OFF Possible

<DEQ5 control display example>

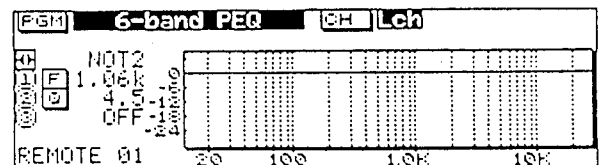
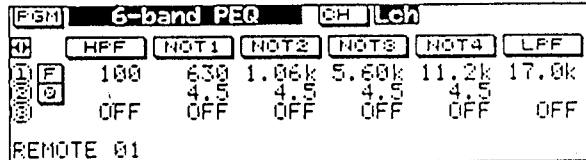

* The parameter can be set while checking the graph of the overall frequency characteristics.

(3) Hum Cancel

Like the Filters, the hum cancel filter can be independently set for each channel in either equalizer mode.

Parameter contents are as follows.

- Hum cancel mode AUTO ↔ MANUAL
 - AUTO The frequency to be canceled in relation to the power supply frequency is automatically set by the DEQ5E.
 - MANUAL The frequency and its harmonics set in “Cancel frequency range” are canceled.
- Cancel frequency range 40Hz~160Hz (1Hz step)
- Threshold level -80~-20dB (1dB step)

(4) Digital Delay/Polarity (Phase inversion)

Like filters, Digital Delay/Polarity can be set for each channel independently in either equalizer mode.

Parameter contents are as follows.

- Delay time variable range 0.021~656 ms (when sampling frequency is 48kHz)
- Delay time variable step in a unit of one sample
- Phase polarity NORMAL ↔ REVERSE

(5) Attenuator

Like the Filters, the attenuator can be independently set for each channel in either equalizer mode.

Parameter contents are as follows.

- Attenuation amount of input level (before the effect processing) 0.0~50,∞dB (0.1dB step during 1~10, and 1dB step during 10~50 step)
- Attenuation amount of output level (after the effect processing) 0.0~50,∞dB (0.1dB step during 1~10, and 1dB step during 10~50 step)

<DEQ5 control display example>

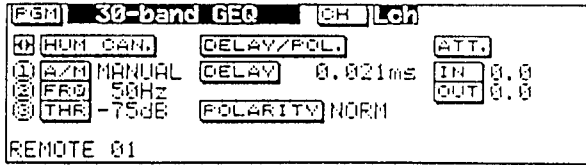

3. UTILITY

The Utility menu is used for changing various settings which are not stored in each program [except for (2) Title Edit].

(1) System setup

Set the following items using UTILITY.

- I/O MODE Select one of the audio input systems from the following.
 - ANALOG: Set to ANALOG when receiving an audio signal from an analog input terminal.
 - PRE SEND: Set to PRE SEND when using an AES/EBU I/O terminal as an insert, as shown in figure I below.
 - POST SEND: Set to POST SEND when using an AES/EBU I/O terminal as an insert, as shown in figure II below.
 - DIGITAL: Set to DIGITAL when receiving a signal from an AES/EBU I/O terminal.

<Fig. I Signal flow during PRE SEND setting>

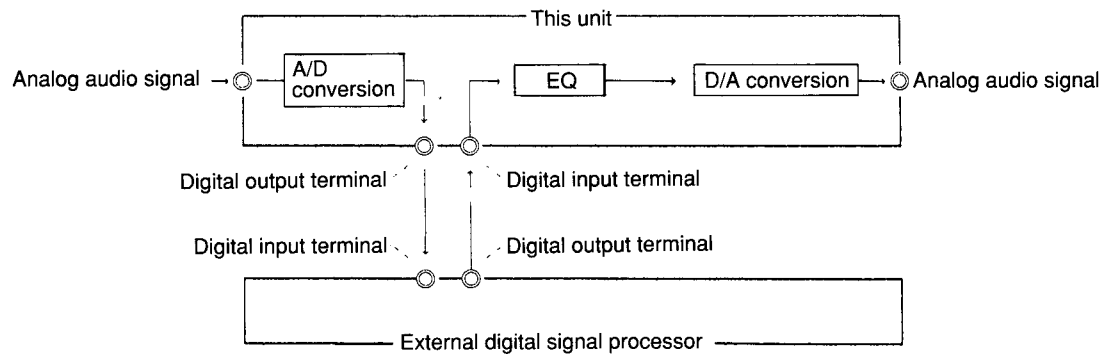

<Fig. II Signal flow during POST SEND setting>

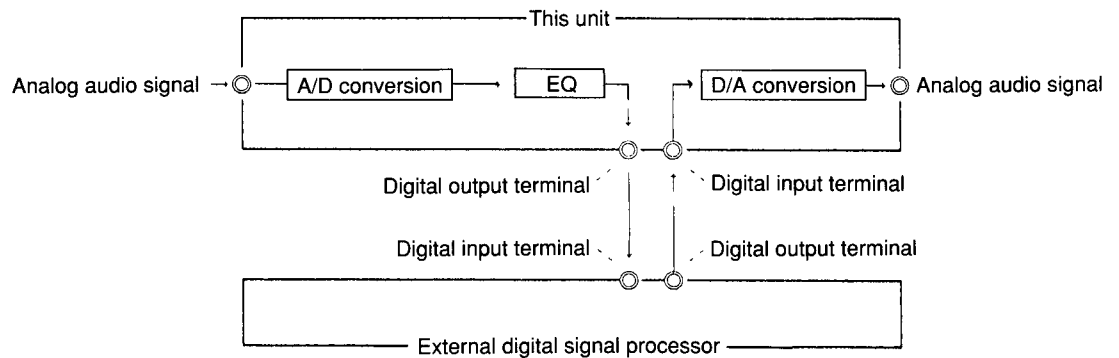

- **IN FORMAT** Select the digital audio input signal format because the DEQ5E is only provided with an “AES/EBU” terminal. Fixed to “AES/EBU”.
- **CLOCK** Set the master clock to operate the DEQ5E with the following types.
 - **INTERNAL:** Set to INTERNAL when operating with the unit’s internal clock.
 - **AES/EBU:** Set to AES/EBU when operating with the clock signal extracted from the signal received through the AES/EBU input terminal.
 - **W.CLK (WORD CLOCK):** Set to W.CLK when operating with the clock signal received through a WORD CLK terminal.
- **EMPHASIS** Set whether to implement pre-emphasis or de-emphasis processing in the process of A/D and D/A conversion of the analog audio signal. If the input audio signal is set to “DIGITAL”, “PRE SEND” or “POST SEND”, the de-emphasis processing ON/OFF setting in this unit’s D/A conversion section is determined here.
 - **ON:** Set ON to implement emphasis processing.
 - **OFF:** Set OFF to not implement emphasis processing.
 - **AUTO:** Set this when either “DIGITAL”, “PRE SEND”, or “POST SEND” is selected in I/O mode. This setting automatically enables de-emphasis processing of the D/A conversion section, in accordance with the emphasis data of the AES/EBU input signal.

<DEQ5 control display example>

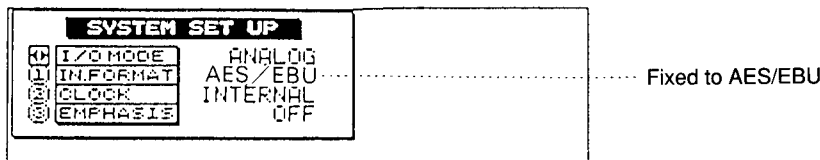

(2) **Title edit**

DEQ5E can store up to 40 programs of created data in its memory. A title name can be assigned to each program. You can input a total of sixteen letters for one title.

☆ The titled data, once you are finished with this menu, is stored together with the created equalizing data in the memory as a part of the equalizing program.

<DEQ5 control display example>

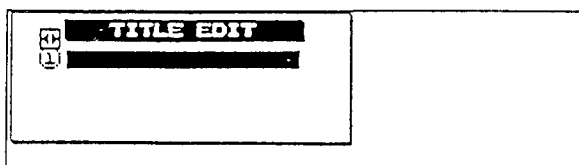

Character code table

ASCII	Character	ASCII	Character	ASCII	Character
20H	Blank	3FH	?	5 DH]
21H	!	41H	A	61H	a
23H	#	42H	B	62H	b
25H	%	43H	C	63H	c
26H	&	44H	D	64H	d
27H	'	45H	E	65H	e
28H	(46H	F	66H	f
29H)	47H	G	67H	g
2AH	*	48H	H	68H	h
2BH	+	49H	I	69H	i
2CH	,	4AH	J	6AH	j
2DH	-	4BH	K	6BH	k
2EH	.	4CH	L	6CH	l
2FH	/	4DH	M	6DH	m
30H	0	4EH	N	6EH	n
31H	1	4FH	O	6FH	o
32H	2	50H	P	70H	p
33H	3	51H	Q	71H	q
34H	4	53H	R	72H	r
35H	5	53H	S	73H	s
36H	6	54H	T	74H	t
37H	7	55H	U	75H	u
38H	8	56H	V	76H	v
39H	9	57H	W	77H	w
3AH	:	58H	X	78H	x
3CH	<	59H	Y	79H	y
3DH	=	5AH	Z	7AH	z
3EH	>	5BH	[

(3) Bulk dump

The Bulk dump function enables transmission and reception of data between this and another DEQ5(E), through the RS-485 terminal.

Items which can be transmitted or received are as follows.

- ALL All the data the DEQ5E possesses (Memory contents/System setup, etc.)
- SYSTEM System data such as system setup, etc. of DEQ5E.
- MEMORY One or all of memory Nos. 1 through 40 of the DEQ5E (it is possible to specify a memory No. or "ALL" in the item "NO").
- BANK One or all of the menu settings of UTILITY "RS485 PGM CHANGE" of the DEQ5E (It is possible to specify a BANK name or ALL in the item "NO").

<DEQ5 control display example>

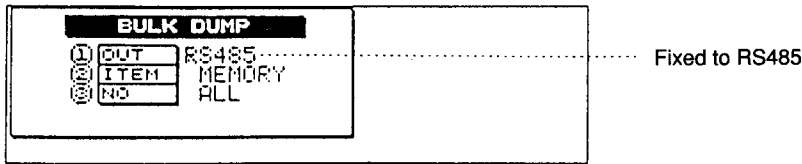

(4) RS485 network

When using the RS-485 terminal, specify the address of the device to be controlled.

The following items should be set.

Local address and Baud rate settings are displayed simultaneously when controlled by a DEQ5, but cannot be changed at this point.

(Refer to "Local Address setting" on page 20.)

- GROUP * (Broadcast), 1~7
- DEVICE * (Broadcast), 1~31

☆ For further information on RS-485 network, please refer to "RS-485" on page 25.

<DEQ5 control display example>

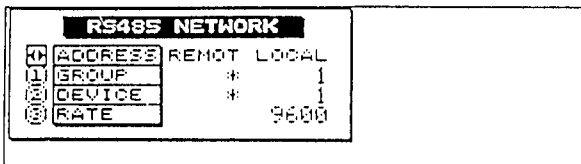

(5) RS485 communication I/O

When parameters are changed, memory is recalled by DEQ5's panel control, or bulk dump is controlled by DEQ5 or a personal computer, and data is transmitted through the RS-485 circuit to a DEQ5(E) with identical communication conditions (the same address).

RS485 communication I/O specifies the transmission contents of the various data, and the reception contents from other devices.

The contents are as follows.

- OFF: No transmission or reception is possible.
- PGM CHANGE: Only program changes can be transmitted, but all data can be received. (BULK OUT is possible)
- ALL: All data (Program Change and Parameter Set Value) is transmitted and received.

<DEQ5 control display example>

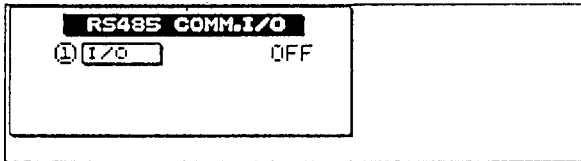

(6) Parameter copy

This menu is provided for copying parameters in the edit area. Note that data to be copied to can be rewritten.

- FROM/TO Selects data to be copied to and data to be copied. Selecting FROM (to be copied) determines TO (to be copied to) automatically as shown below.

FROM

TO

- GEQ INITIAL DATA —————> EDIT AREA Recalls GEQ initial data from the initial data area to the edit area.
- PEQ INITIAL DATA —————> EDIT AREA Recalls PEQ initial data from the initial data area to the edit area.
- L-DATA —————> R-DATA Copies parameter data, recalled in the edit area, from the L side of the program to the R-side parameter.
- R-DATA —————> L-DATA Copies parameter data, recalled in the edit area, from the R side of the program to the L-side parameter.

- ITEM If “L-DATA” or “R-DATA” is selected for FROM, a parameter to be copied can be selected.
 - ALL All the parameter values.
 - EQ Parameter values set in the Equalizing menu.
 - FILTER Parameter values set in the Filter menu.
 - HUM CAN Parameter values set in the Hum Filter menu.
 - DELAY/POL Parameter values set in the Digital Delay/Polarity menu.
 - ATT Parameter values set in the Attenuator menu.

<DEQ5 control display example>

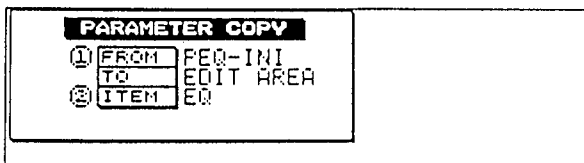

(7) Software protect

Set the item "OPERATION" to "ON" to prevent stored data from being overwritten due to unintended misoperations, or internal data from being overwritten by received bulk data, parameter changes, etc.

Even if this menu is set to "ON", the memory recall function is enabled.

<DEQ5 control display example>

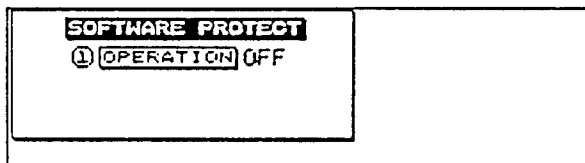

(8) RS-485 Program Change table

Create a corresponding table between the Program Change (memory change command) numbers received through RS-485 circuit and the memory numbers you want to recall by the DEQ5E.

Four types (BANK A~D) of tables can be created and the BANK recalled by this menu is executed.

- BANK Selects a corresponding table from A to D
- PGM Received Program Change number (1~128)
- MEM Memory number recalled by the DEQ5E (1~40)

<DEQ5 control display example>

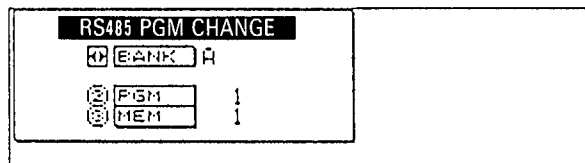

4 REMOTE CONTROL BY DEQ5

1. Concept of Remote Control

DEQ5 can control up to 24 DEQ5s or DEQ5Es, including itself.

A DEQ5's front panel controls itself when "CONTROL SELECT" is set to "INT", and it controls other DEQ5(E)*s when it is set to "1" through "23".

* The "DEQ5(E)" in this manual refers to DEQ5 or DEQ5E.

When CONTROL SELECT is set to "INT".

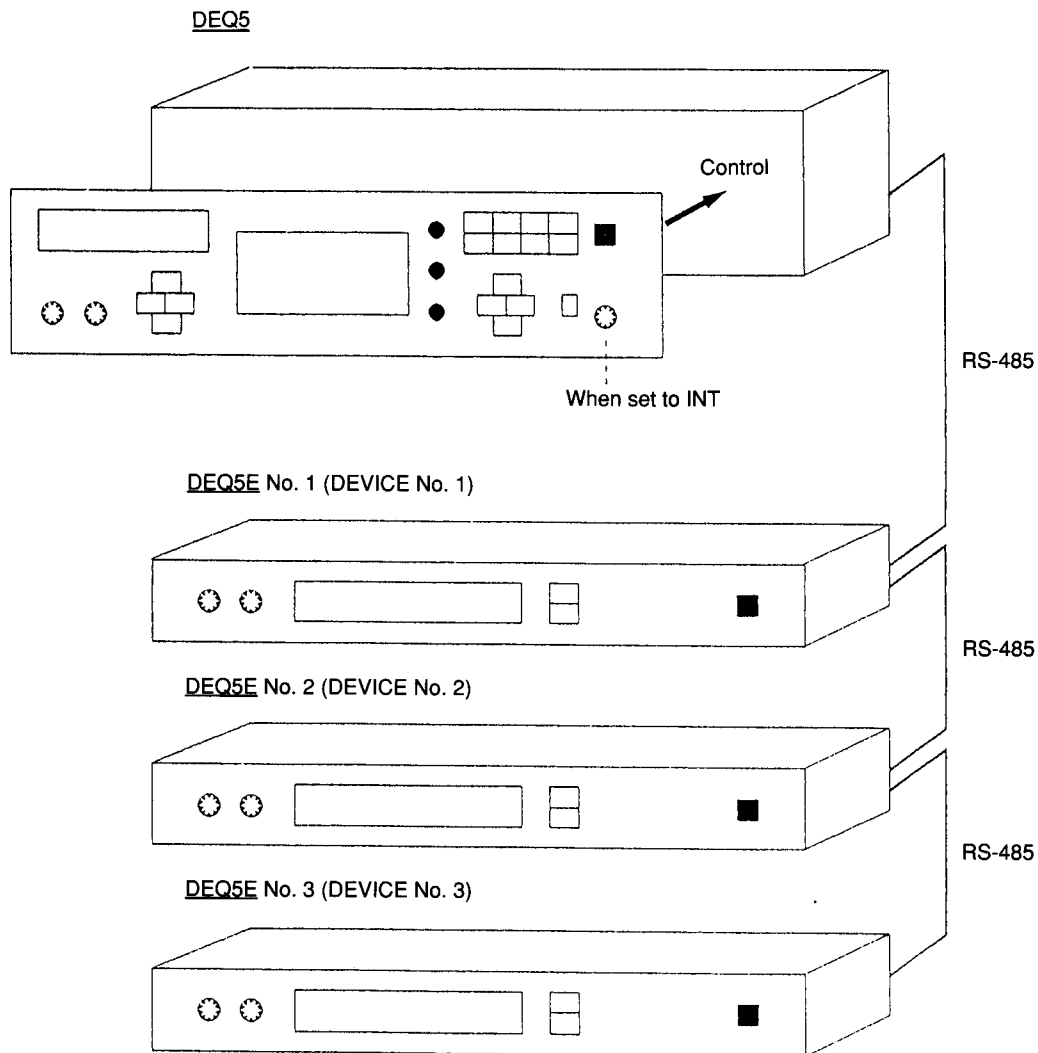

When CONTROL SELECT is set, except for "INT".

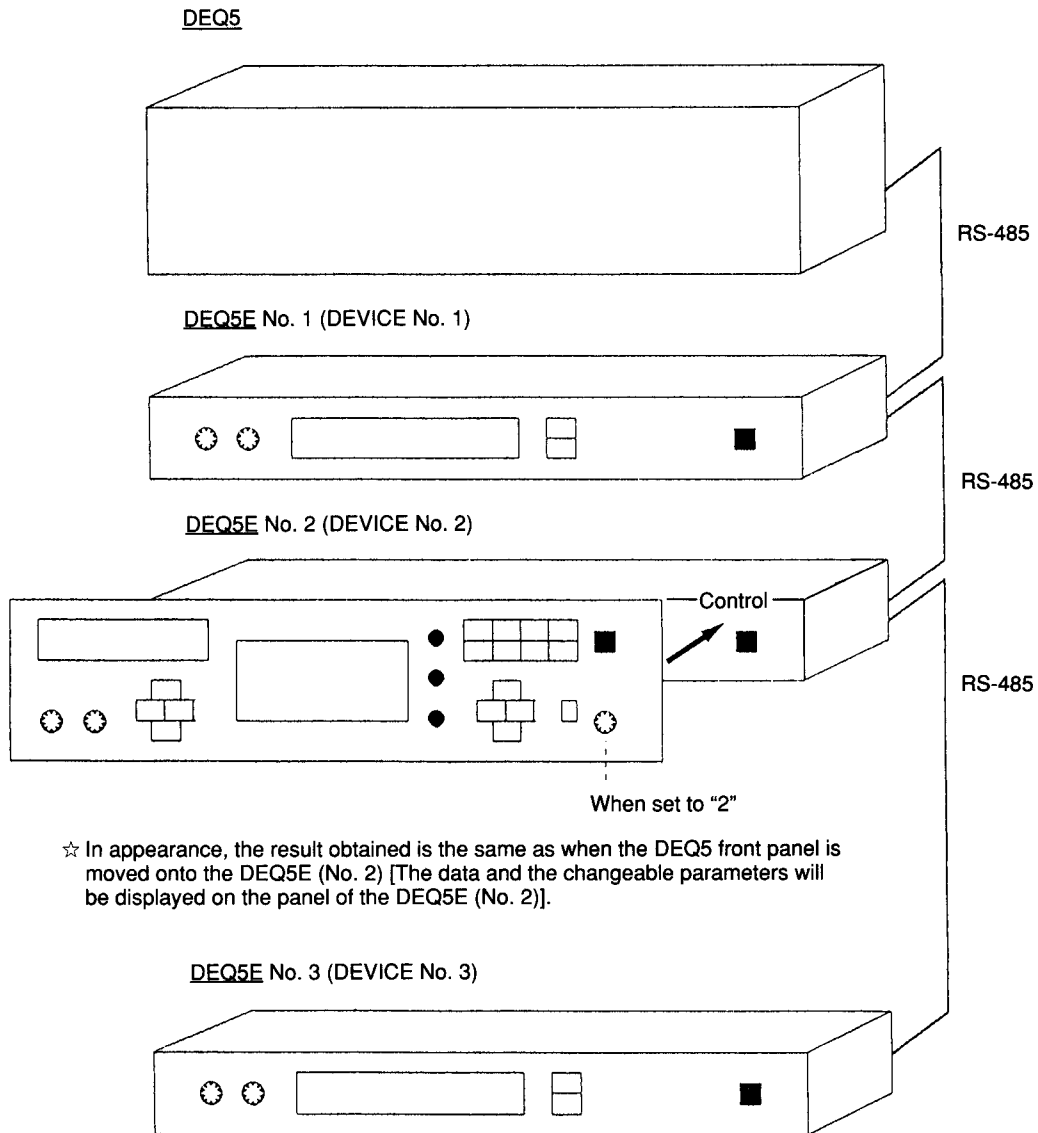

☆ In appearance, the result obtained is the same as when the DEQ5 front panel is moved onto the DEQ5E (No. 2) [The data and the changeable parameters will be displayed on the panel of the DEQ5E (No. 2)].

As shown above, it can be thought of in this way: Move the DEQ5 front panel which serves as a control panel by changing the "CONTROL SELECT". Where the panel goes is determined by settings in the UTILITY "Remote Assign menu".

2. Remote Assign Setting

This sets how the DEQ5 “CONTROL SELECT” number and the DEQ5(E) local address correspond to each other. This is set in DEQ5 the “UTILITY” “REMOTE ASSIGN” menu.

CONTROL SELECT #	GROUP#	DEVICE #
1	1	1
2	1	2
⋮	⋮	⋮
23	1	23

If you set the “CONTROL SELECT” and the “DEVICE” number to the same value as shown in the table above, it will be easy to understand how they correspond to each other.

In this case, the DEQ5(E) Local address should be also set by selecting from the table above.

3. Local Address Setting

<Group number setting>

- ① Hold down the front panel “GROUP” key for more than 2 seconds.

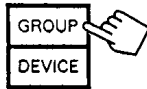

Ⓜ (G) and the number displayed in the “DEVICE” LED will flash. A Group number may then be input. Flashing will continue for approximately 2 seconds.

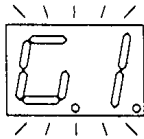

Flashing

- ② Input a certain Group number by pressing the “GROUP” key several times, or hold the key down while the LED display flashes.

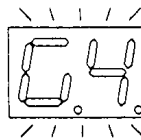
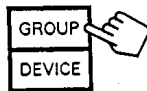

Flashing

- ③ A number you input will be set after approximately two seconds. Also, pressing the “DEVICE” key after a number has been input will set the number. After 2 seconds, the display will light. If you press the “DEVICE” key at this point, the device number will display, but the group number input in step 2 will still be effective.

<Device number setting>

- ④ Hold down the “DEVICE” key on the front panel for more than 2 seconds.

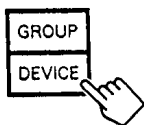

The number displayed in the “DEVICE” LED will flash, and a DEVICE number may then be input. Flashing continues for approximately 2 seconds.

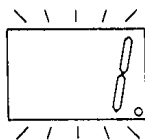

Flashing

- ⑤ Input a certain Device number by pressing the “DEVICE” key several times, or hold the key down while the LED display flashes.

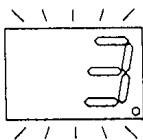
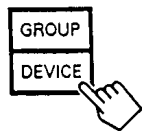

Flashing

- ⑥ A number you input will be set after approximately two seconds. Also, pressing the “GROUP” key after a number has been input will set the number. After 2 seconds, the display will light. If you have pressed the “GROUP” key, the display changes to Group Number, and 2 seconds later it changes to the Device number.

4. Connection

<Network configuration example>

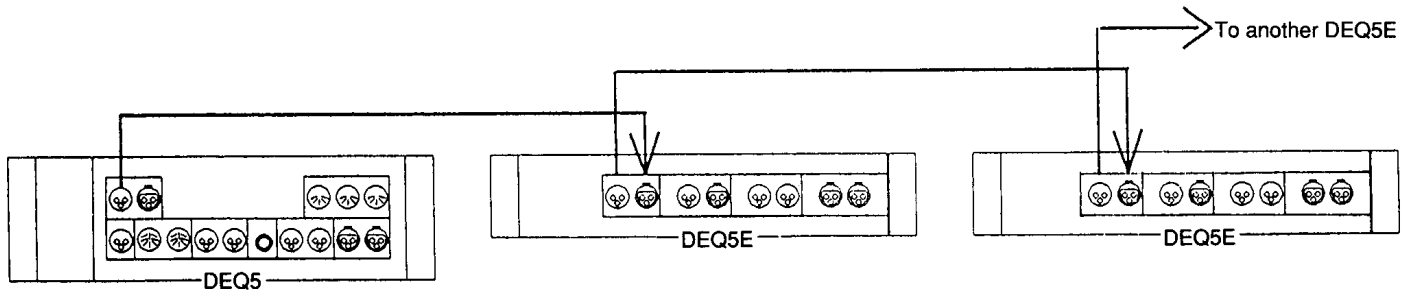

Connection should be carried out as shown above.

- ☆ A digital audio signal transmission cable is recommended for the connection.
- ☆ Under the RS-485 standard, one cable enables bi-directional data communication.
The signal flow direction (male to female/female to male) in accordance with the shape of the terminal is not specified.

[Baud rate setting]

Set the "BAUD RATE" select switch on the rear panel to the device baud rate while the power is OFF.

Set this before turning on the power supply.

All the devices connected through RS-485 should be set to the same Baud Rate.

Note) If you attempt to change the baud rate with the "BAUD RATE" select switch while power is ON, the baud rate will not change.

5 CONTROL BY A COMPUTER

1. Control using RS-485 terminal

The DEQ5E can be controlled with a computer by constructing the following system.

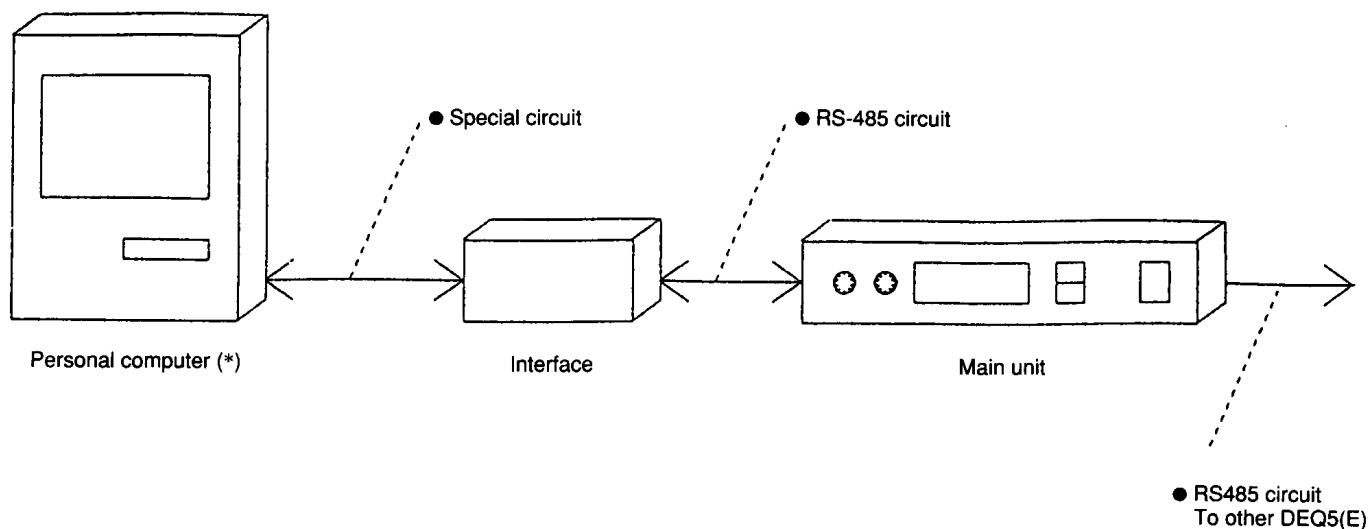

* To control DEQ5E, DEQ5(E) control software is required for the personal computer.

☆ It is also possible to simultaneously control multiple DEQ5(E)s from one personal computer, or to control specific DEQ5(E)s by connecting DEQ5(E) (except for the unit) through the unit in serial with RS-485 circuit.

☆ If you require materials (protocol, etc.) for programming software to control DEQ5(E), please contact your nearest YAMAHA.

2. Control using MIDI (RS-485 circuit via DEQ5)

The DEQ5E does not have a MIDI I/O terminal. However, it can communicate special data to a MIDI device through the following system.

[Example] Method of going via DEQ5

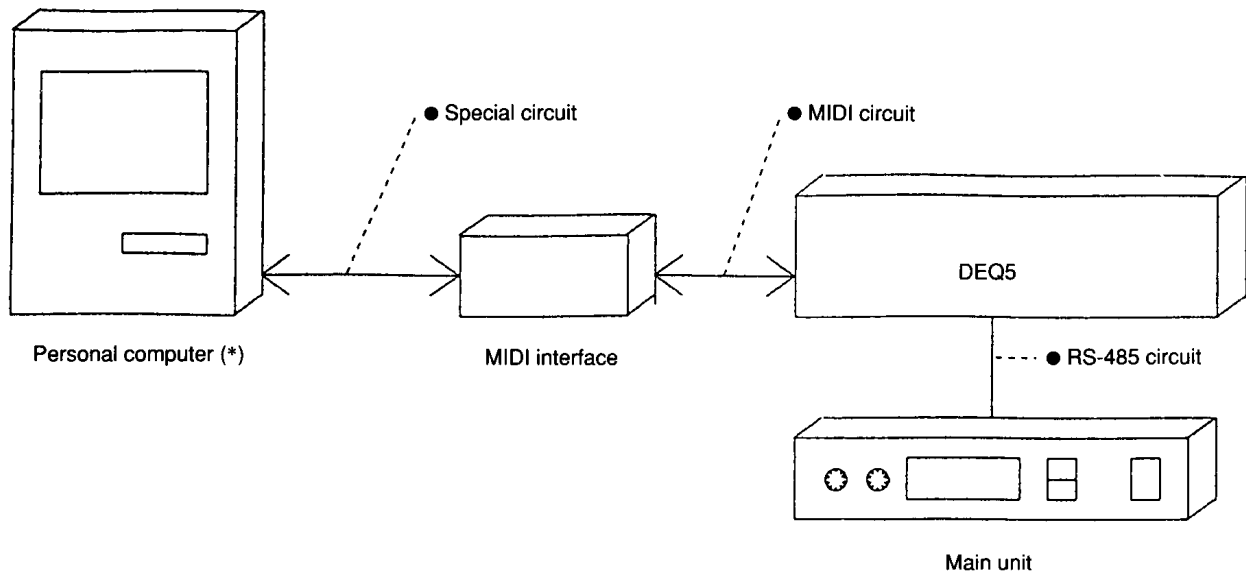

☆ Contact your nearest YAMAHA dealer if you require materials (protocol, etc.) for programming software to control the DEQ5(E) by using a personal computer and MIDI.

6 RS-485

1. RS-485

RS-485 is an interface standard which enables multi-point communication, established by the Electronic Industrial Association (EIA) in the USA.

The familiar RS-232C is also an EIA standard. Compared with RS-232, RS-485 features multi-point communication: long distance, (*) high speed transmission with balanced electrical transmission capabilities.

* Long distance transmission (up to several hundred meters) is possible equally at either transmission speed (38400 or 9600 BAUD).

However, cable quality or other factors may cause problems with long distance data transmission.

Avoid using unnecessarily long cable if the devices are close to each other, and use a reliable cable if long distance transmission is required.

<RS-485 enables bus configuration>

Bus configuration enables communication among multiple devices.

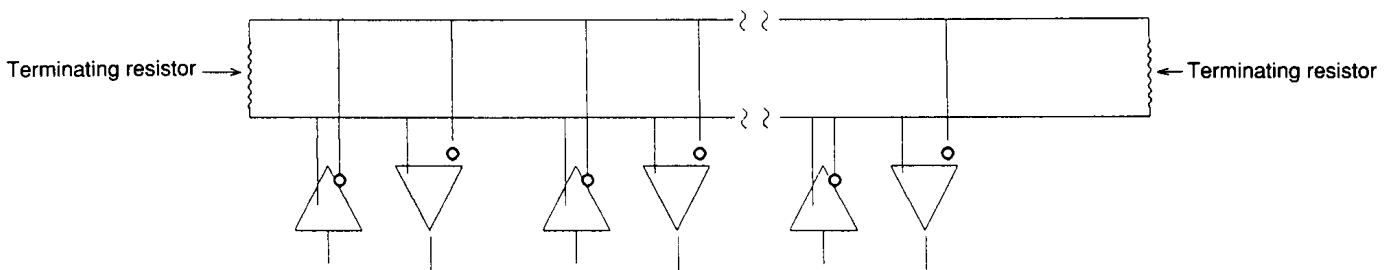

RS-485 standards are the electrical characteristics for high speed communication. It may not be possible to communicate between all the devices provided with RS-485. Communication is only possible when all devices are provided with the appropriate communication software, and are set to the correct format (Protocol).

It is possible to communicate with other DEQ5(E)s through the RS-485 provided with this unit, but it is not possible to communicate control data to devices with other transmission formats.

However, devices other than the DEQ5(E) (a personal computer or equivalent device) which have started up software for controlling the DEQ5 through its RS-485 do not apply. (*)

* Please use an RS-232C or RS-422 ↔ RS-485 conversion box to connect the DEQ5(E) to devices only equipped with a RS-232C or RS-422 terminal. (a personal computer for example)

2. Connection

Please use a digital audio cable (impedance 90~120Ω, shielded type balanced transmission cable) for connection with peripheral devices.

Using the general analog audio cable (impedance 40~50Ω shielded type balanced transmission cable) could cause problems, such as signal reflection due to mismatching impedance, or transmission wave form turbulence. When using a long cable or multi cables longer than 10 meters wave form turbulence is especially noticeable.

If the length of the cable is longer than 100 meters, we recommend that it be terminated with a resistor matching the impedance of the cable. (connect the resistor between Pin 2 and Pin 3)

3. Communication bus standard

Communication method: Complies with EIA RS-485, asynchronous type
 Baud rate: 38.4/9.6 k baud (*1)
 Connector: XLR type male type or female type (*2)
 Pin assign: 1 Ground
 2 Tx+/Rx+
 3 Tx-/Rx-

Baud rate 9600/38400BPS
 Start bit 1 bit
 Stop bit 1 bit
 Data bit 8 bit
 Parity Even number Parity

	Logic	Pin2	Pin3
Mark	1	High	Low
Space	0	Low	High

*3

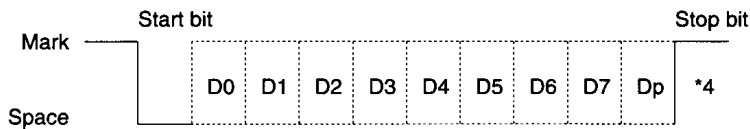

- *1 The standard baud rate should be 9600 baud, but 384000 baud can be used if to transmit at higher speeds.
- *2 Both male and female connectors are provided to simplify connection between devices.
- *3 Set the devices connected to the RS-485 bus to high impedance, except when transmitting.
 Before a transmission, make sure that the bus is set to high impedance, to avoid signal collision on the bus.
- *4 Dp indicates even number parity.

4. Definition of address

(1) Local address

The number that identifies one DEQ5(E) from other DEQ5(E)s on a RS-485 network is called its “Local Address”.

(2) Remote address

By specifying the local address of the recipient, transmission to devices with the specified local address is possible.

(3) Group number and Device number

An address is a combination of two types of numbers: Group and Device.

Group number can be set to between 1 through 7, and the Device number can be set to between 1 and 31.

(4) Broadcast address

The Remote address can specify Broadcast address (“*” for DEQ5), which enables transmission to an entire Group or Devices, except for the above mentioned setting range. When a Broadcast address is set, it is possible to transmit data to a specified group.

[Example 1] When Group number is set to Broadcast

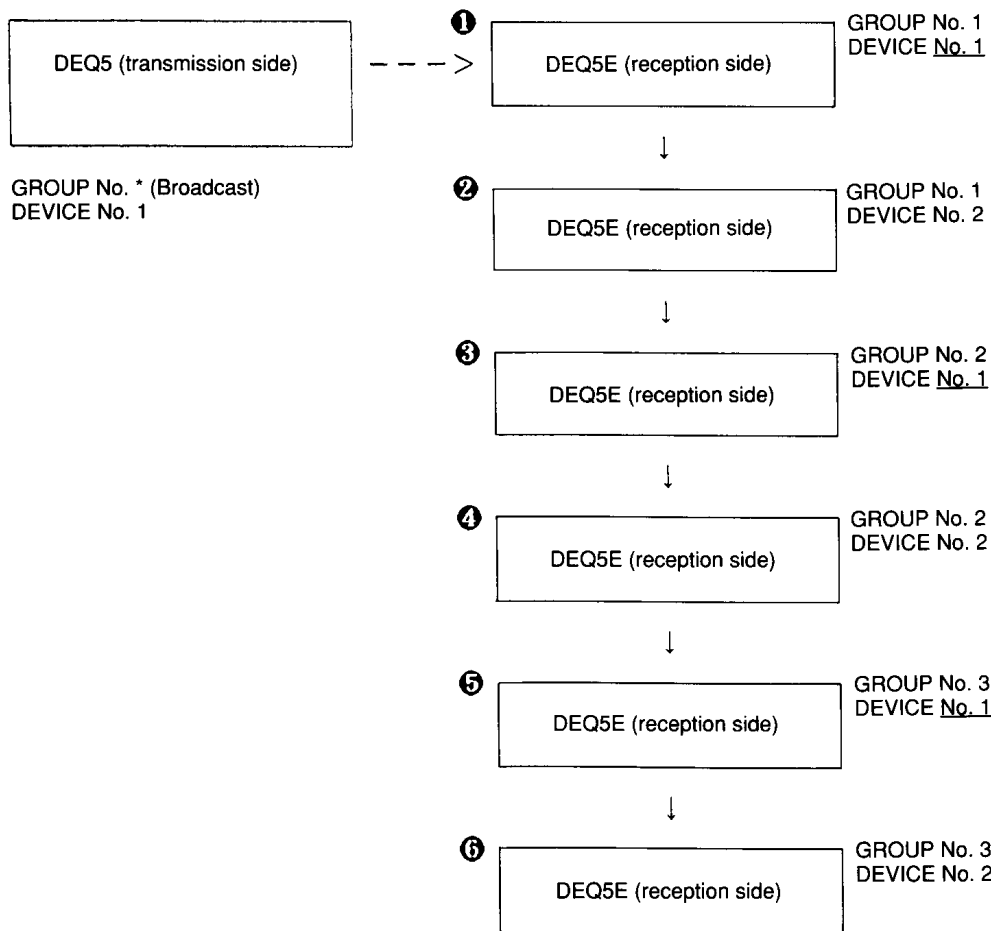

When transmission and reception setting is made as shown above, only the devices with its Device number set to “1” (①, ③, and ⑤ in the above case) respond to the remote control signal received from DEQ5, despite the Group number setting on the recipient side.

[Example 2] When Device number is set to Broadcast

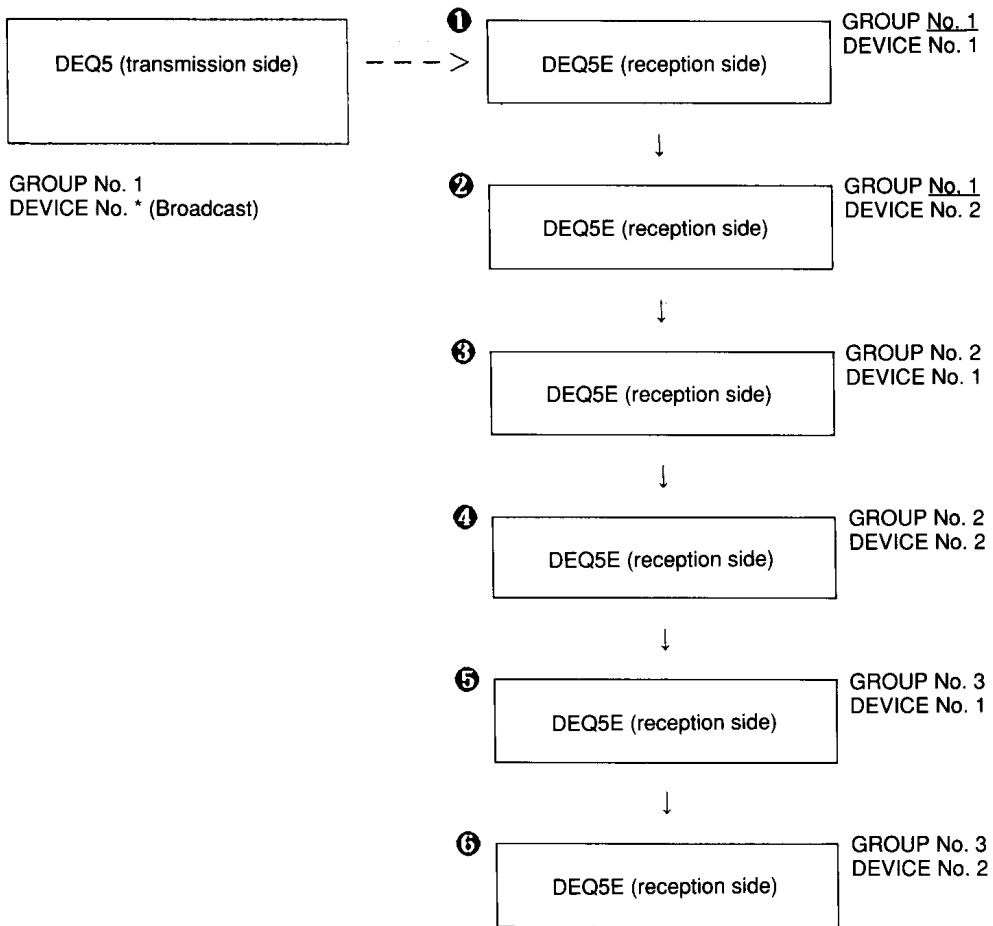

When transmission and reception setting is made as shown above, only the devices with its Group number set to "1" (① and ② in the above case) respond to the remote control signal received from DEQ5, despite the Device number setting on the recipient side.

[Example 3] When both Group and Device numbers are set to Broadcast

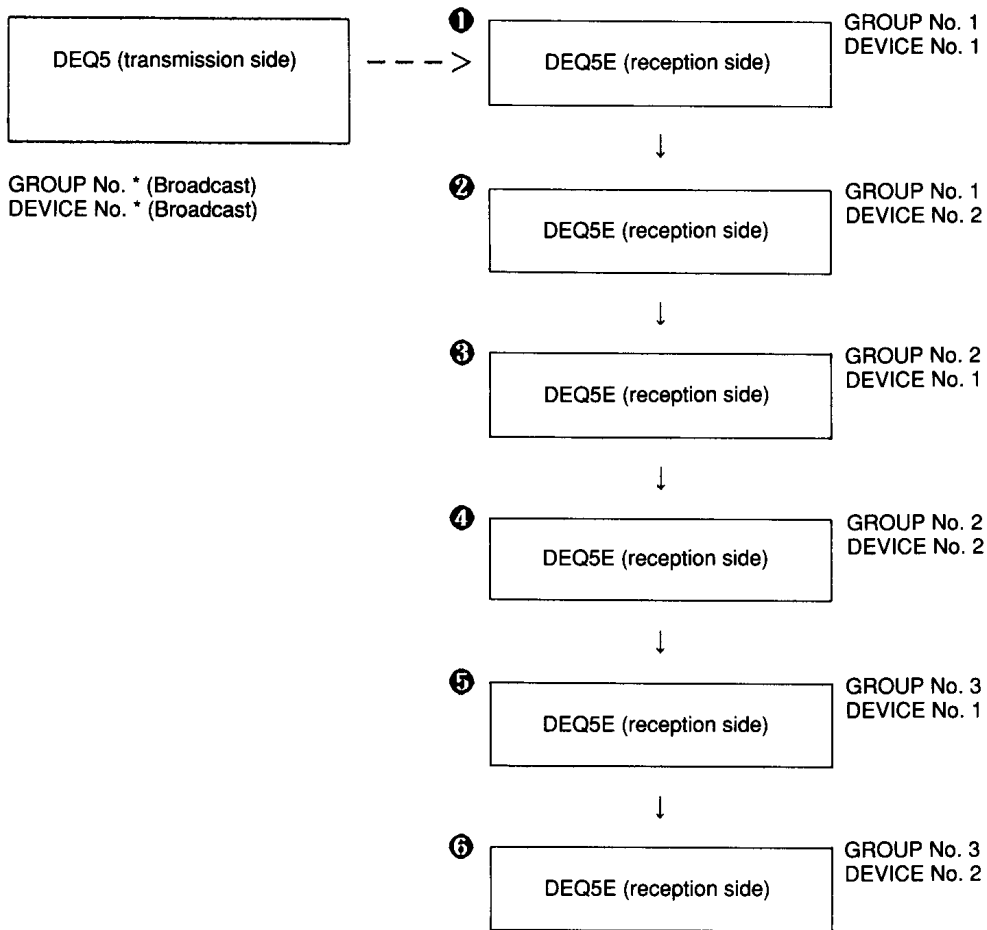

When transmission and reception settings are made as shown above, all the DEQ5Es respond to the remote control signal received from DEQ5.

5. What is possible with RS485

The following data can be transmitted from the remote side DEQ5(E) to the local side DEQ5(E).

(1) **Parameter Change**

Data when the parameter data is edited.

(2) **Program Change**

Data when the memory is recalled.

(3) **Bulk dump**

Data regarding memory and system.

7 SPECIFICATIONS

Audio characteristics

Frequency characteristics	20Hz~20kHz 0±0.5dB (fs=48kHz)
S/N ratio	110dB typ (when emphasis is ON) 105dB or more (when emphasis is ON) 107dB typ (when emphasis is OFF) 102dB or more (when emphasis is OFF)
Distortion rate	0.007% or less (when 1kHz, +24dBm output emphasis is OFF)

Analog input

No. of channels	2 (electronic balance)
Rating input	+4dBm
Maximum input	+24dBm
Input impedance	20kΩ
Connector	XLR-3-31 type

Analog output

No. of channels	2 (electronic balance)
Rating output	+4dBm
Maximum output	+24dBm (when load is 600Ω)
Output impedance	150Ω
Connector	XLR-3-32 type

A/D, D/A conversion

A/D conversion	19 bit
D/A conversion	20 bit
Sampling frequency	48kHz (when synchronized with internal clock)

Memory 1~40 (user memory)

Digital input AES/EBU format (XLR-3-31 type connector)

Digital output AES/EBU format (XLR-3-32 type connector)

WORD CLOCK input TTL level, BNC connector

RS-485 terminal XLR-3-31, XLR-3-32 type connectors

Indicator

MEMORY number	7 segment LED × 2
DEVICE number	7 segment LED × 2
IN level meter	8 element LED × 2 (L, R) (digital signal level after A/D conversion)
OUT level meter	8 element LED × 2 (L, R) (digital signal level before D/A conversion)

Power supply, Power consumption

U.S. & Canadian Models	AC120V 60Hz 30W
British Model	AC240V 50Hz 30W
General Model	AC230V 50Hz 30W

Dimension (W × H × D) 480 × 45.3 × 331.1 mm

Weight 4.1 kg

Block diagram

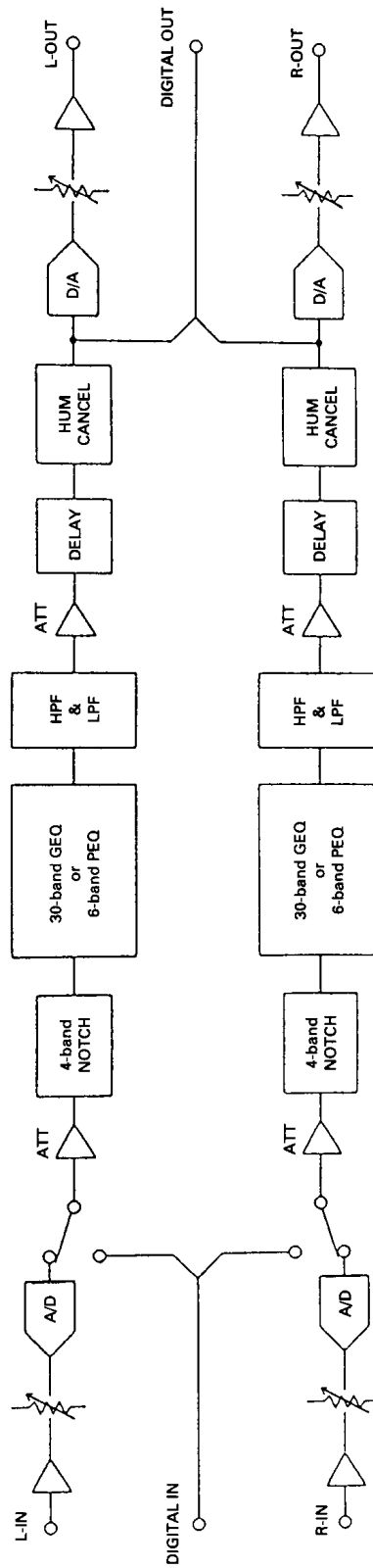

Dimensional drawing

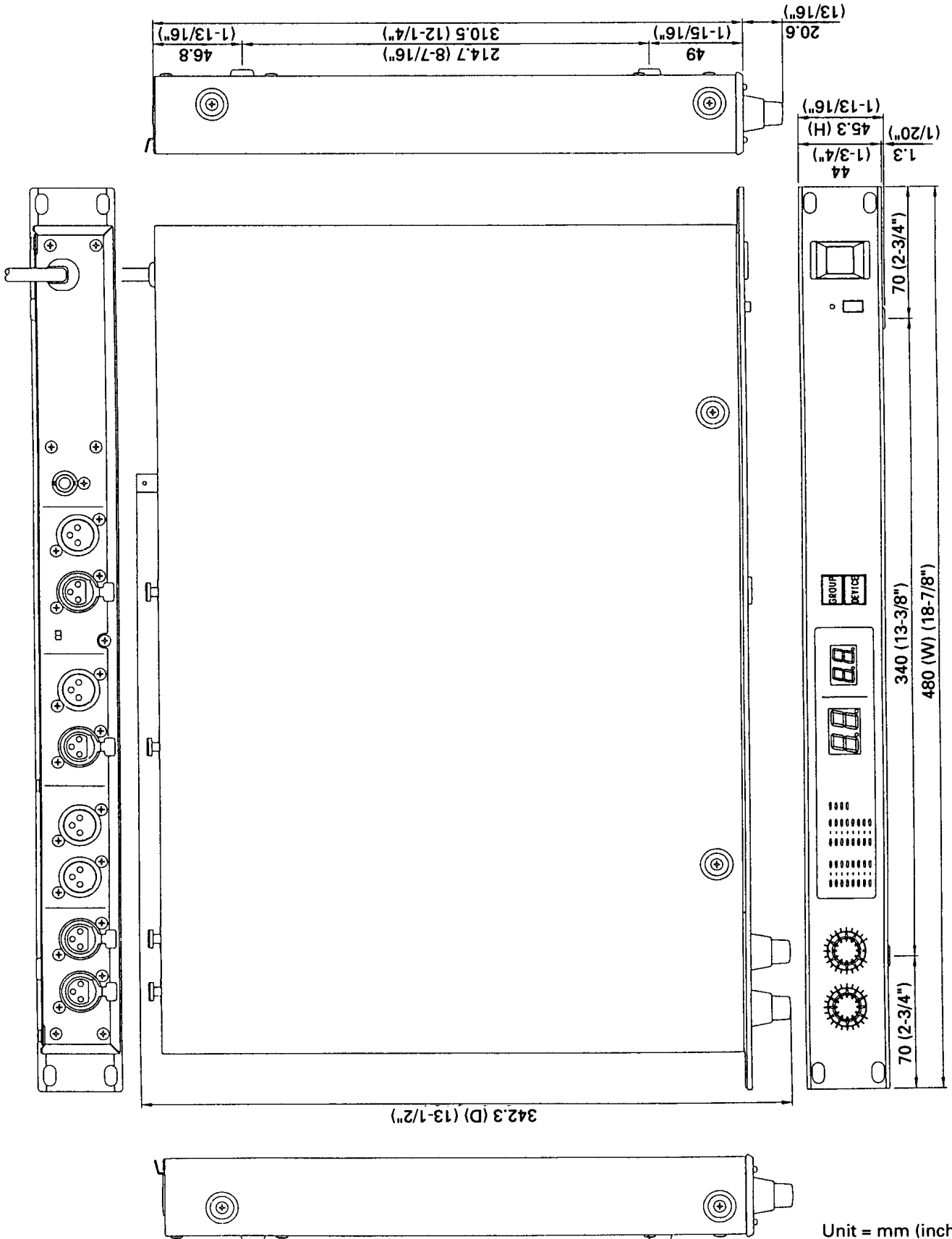

Litiumbatteri!
Bör endast bytas av servicepersonal.
Explosionsfara vid felaktig hantering.

VAROITUS!
Lithiumparisto, Räjähdyksvaara.
Pariston saa vaihtaa ainoastaan alan
ammattimies.

ADVARSEL!
Litiumbatteri!
Eksplosionsfare. Udsiftning må kun foretages
af en sagkyndig, – og som beskrevet i
servicemanualen.

SERVICE

This product is supported by YAMAHA's worldwide network of factory trained and qualified dealer service personnel. In the event of a problem, contact your nearest YAMAHA dealer.

ENTRETIEN

L'entretien de cet appareil est assuré par le réseau mondial YAMAHA de personnel d'entretien qualifié et formé en usine des concessionnaires. En cas de problème, prendre contact avec le concessionnaire YAMAHA le plus proche.

KUNDENDIENST

Für dieses Gerät steht das weltweite YAMAHA Kundendienstnetz mit qualifiziertem, werksgeschultem Personal zur Verfügung. Bei Störungen und Problemen wenden Sie sich bitte an Ihren YAMAHA-Händler.

YAMAHA

YAMAHA CORPORATION
PO Box 1, Hamamatsu, Japan

VN32030 92070.1 R2 ① Printed in Japan