



YAMAHA
Make Waves

TRUMPETS

CORNETS/FLUGELHORNS



Custom Trumpets

After earnest dedication and single-minded focus on pursuing our ideal tone and resonance, the name *Custom* is given to the best of Yamaha's creations made with the utmost love and passion to build musical instruments.

While incorporating high craftsmanship backed by decades of experience with the right mix of the latest sophisticated technology, we have repeatedly held sessions with the world's leading artists and utilized our engineering expertise to translate their image into reality.

This consistent attitude is the reason Yamaha have long been supported by so many musicians, as *Custom* has kept proving itself by the prospect of joy you would feel before even playing a note. The next moment you take your musical breath, the instrument will become a part of yourself — unleashing your artistry into the open air.





Xeno Artist Model Trumpets

The “Chicago” Series



The Chicago Series was developed in close cooperation with John Hagstrom of the Chicago Symphony Orchestra. A fusion of orthodox style and state-of-the-art design achieves free blowing resistance and a tone that is both brilliant and deep. The C and B \flat trumpets have consistently outstanding feel and playability throughout their ranges, so switching instruments is smooth and seamless.

B \flat Trumpet

YTR-9335CHS *MalonePipe™*

Key=B \flat

Bell: one piece yellow brass, 123 mm (4-7/8")

Bore size: ML – 11.65 mm (0.459")

Finish: silver plate

Mouthpiece: TR17B4



YTR-9335CHS

C Trumpet

YTR-9445CHS *MalonePipe™*

Key=C

Bell: one piece yellow brass, 123 mm (4-7/8")

Bore size: L – 11.73 mm (0.462")

Finish: silver plate

Mouthpiece: TR17B4



YTR-9445CHS



Main tuning slide / Water key

A square main tuning slide that provides enhanced overall playing feel and tonal balance has been adopted in the Chicago series and New York series. A new rubber cork material* that is more resistant to deterioration over time is used for the water key seal. These modifications contribute to improved definition, projection, and response.

* Rubber cork: Cork particles are evenly distributed through a synthetic rubber, achieving greater compression resilience than conventional cork.

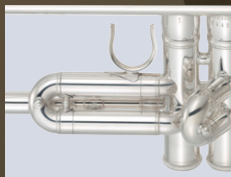

1st Valve Slide

The first valve side has a special brace for a stronger focus to the core of the tone, resulting in unparalleled definition and clarity. (Chicago Series)



French bead

Unlike traditional methods where a round rim is used in curling, French bead is an extremely advanced technique that matches the curling to the shape of a semi-cylindrical rim and is characterized by improved feedback of sound to the performer. (Chicago Series/New York Series)



Reversed tuning slide

The leadpipes are based on Bob Malone's own design and on the C its long taper ends in a reversed tuning slide. These leadpipes are largely responsible for the tonal expressivity of the trumpets, and you will find that notes slot easily and comfortably in all ranges, with exceptionally accurate intonation. (YTR-9445CHS)



3rd valve slide

The 3rd valve slide stopper is positioned to allow the slide to be extended further than normal so that accurate low E \flat (9445CHS: F) pitch can be achieved. The button at the tip of the slide and the quarter circle stopper ring help to fine-tune the playing resistance for superior comfort and playability. (Chicago Series/YTR-9445NYS)



Case: TRC-801E

TRC-801E double case that can be carried in your hand, over your shoulder, or like a backpack.



Series Background

Many players spend their careers in the elusive search for the ideal trumpet. Even after tweaking their horns with custom-made lead pipes and other parts, these players struggle to find the sound they're looking for. They don't compromise in their playing, so why should they settle for less than the best in an instrument? With the Xeno, Yamaha takes up the challenge of creating a trumpet series more expressive than even the finest individually customized instruments.

The "New York" Series



The New York Series was developed in cooperation with Robert Sullivan, former associate principal trumpet with the New York Philharmonic, and David Bilger, principal trumpet with the Philadelphia Orchestra. Based on traditional styling with advanced refinements, the New York Series offers superb presence and brilliance with solid playing resistance. The YTR-9445NYS-YM model, a C trumpet, features a YM bell for even clearer, tighter tone, and is a favorite with the Boston Symphony Orchestra trumpet section.



B \flat Trumpet

YTR-9335NYS *MalonePipe™*

Key=B \flat

Bell: one piece yellow brass, 123 mm (4-7/8")

Bore size: ML – 11.65 mm (0.459")

Finish: silver plate

Mouthpiece: TR17B4



YTR-9335NYS

C Trumpet

YTR-9445NYS *MalonePipe™*

Key=C

Bell: one piece yellow brass, 123 mm (4-7/8")

Bore size: L – 11.73 mm (0.462")

Finish: silver plate

Mouthpiece: TR17B4

Bell type: YS4

YTR-9445NYS-YM

Bell type: YM



YTR-9445NYS-YM

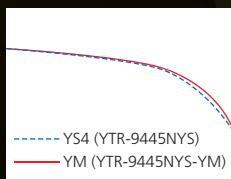

YM bell and YS4 bell

The rapidly flaring YS4 bell on the YTR-9445NYS delivers powerful tone, while the more gently flaring YM bell on the YTR-9445NYS-YM produces clear, well-defined tone.

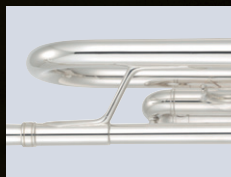

Brace

The shape and position of the braces has been modified to achieve better weight balance that results in quicker response and livelier tone with a solid tonal core. (Chicago Series/New York Series)



Valve casing and pistons

The refined valve casing and lightweight pistons work together to deliver significantly improved response for even greater clarity in detailed passages. (Chicago Series/New York Series)



Bell

The bell features a design that is narrower toward the valve casing, and a square-cornered bell bow that provides the performer with ideal blowing resistance. This results in a more "three-dimensional" sound, with a strong tonal core that improves upper register playability. (Chicago Series/New York Series)



Leadpipe

Utilizing a leadpipe that is thicker than current designs, an original style Malone Pipe™, and a lighter mouthpiece receiver, we've achieved improved tone and response while providing the performer with an ideal blowing resistance. As the finger hook soldering is carefully positioned not to disturb the vibration of leadpipe, you can find the difference of the tone quality and the response as well. (Chicago Series/New York Series)

MalonePipe™ Based on leadpipes designed by renowned brass instrument artisan Bob Malone, the Malone Pipe™ is available in several keys, offering quick response, superior intonation and unparalleled evenness of tone: Originally a trumpet player himself, Bob Malone opened his own custom brass shop in Los Angeles in 1983. Trumpeters flocked to his shop to have him personally customize their horns. His original leadpipe design has enjoyed wide acclaim and is still held in high regard among trumpet players. Since Bob joined Yamaha's Research and Development team in 2001, his Malone Pipe™ design has made its way into a number of Xeno Artist models and Custom series instruments. Rich and brilliant tone with excellent projection, the Malone Pipe™ brings total expression to your music.

Xeno Series Trumpets

Innovation that Inspires

The Xeno Series represents a fusion of craftsmanship that involves outstanding instrument design, advanced technology, and the experience, talent, and dreams of respected artists around the world.

These are trumpets that inspire. Their outstanding power and projection combines with refined resistance and response for extraordinary tonal flexibility. Xeno trumpets continue to evolve with the artists who play them, towards the ultimate goal of ideal musical expression.

B \flat Trumpets

Xeno B \flat Trumpets offer a choice of bore sizes: medium-large for versatility and large for a broad sound with plenty of power.

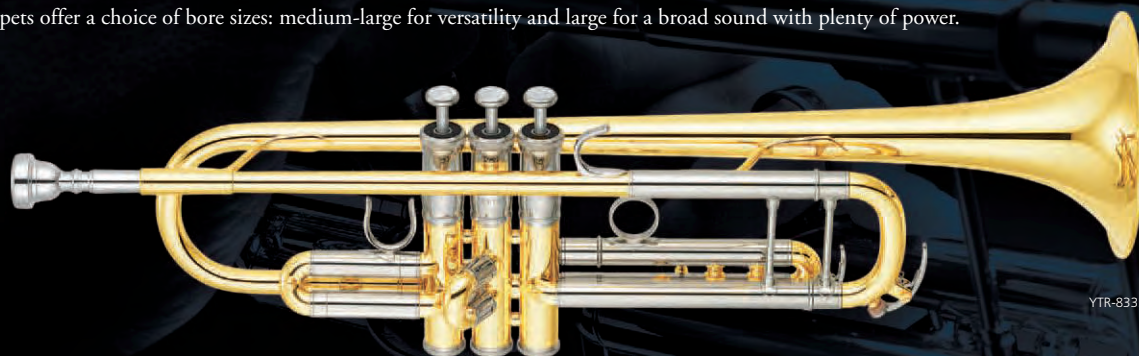

YTR-8335

YTR-8335

YTR-8335 is a medium-sized Xeno B \flat Trumpet with versatile uses.

B \flat and C Xenos have the following bell options: yellow brass for clear sound with strong projection and gold brass for a warmer, deeper sound.

Key=B \flat

Bell: one piece yellow brass, 123 mm (4-7/8")

Bore size: ML – 11.65 mm (0.459")

Finish: clear lacquer

Mouthpiece: TR16C4

With gold brass bell: YTR-8335G

With silver plate finish: YTR-8335S/YTR-8335GS



YTR-8345S

YTR-8345

YTR-8345 is a large-bore Xeno B \flat Trumpet with a broad sound and plenty of power.

Key=B \flat

Bell: one piece yellow brass, 123 mm (4-7/8")

Bore size: L – 11.73 mm (0.462")

Finish: clear lacquer

Mouthpiece: TR16C4

With gold brass bell: YTR-8345G

With silver plate finish: YTR-8345S/YTR-8345GS

Xeno

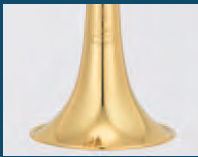

Bell

A new bell design contributes to optimum resistance for a powerful tonal core. The new design also enhances playability in the upper register. (8335/8345/8335RS)

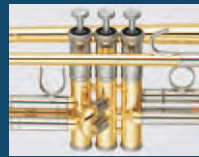

Valve casing and pistons

Thinner valve casing and pistons, as well as the modified angle of the branch tube (kunckle), result in improved response and provide the performer with an ideal blowing resistance. (8335/8345/8335RS)



Button on the 1st slide

The button on the 1st slide is to fine-tune the blowing resistance for better control.



Water key

The height of the main slide water key gutter has been increased for optimum resistance, and the ends of the water key spring have been curled for improved response. (8335/8345/8335RS)

Reversed Tuning slide Model B \flat Trumpet



YTR-8335RS

YTR-8335R

The YTR-8335R adopts a unique “reverse-style” design with staggered main pipe valve slides, creating a smooth response. A heavy mouthpiece receiver and daring removal of the third valve water key results in a superb balance of playability and tonal quality. With this model, musicians will be able to produce a firm sound in all dynamic ranges, from delicate pianissimo to powerful fortissimo.

Key=B \flat

Bell: one piece yellow brass, 123 mm (4-7/8")

Bore size: ML – 11.65 mm (0.459")

Finish: clear lacquer

Mouthpiece: TR16C4

With gold brass bell: YTR-8335RG

With silver plate finish: YTR-8335RS/YTR-8335RGS

YTR-8345R

The YTR-8345R achieves smooth resistance and airflow that only a reverse tuning slide design can offer, for easy, comfortable playability and harmonically rich tone.

Key=B \flat

Bell: one piece yellow brass, 123 mm (4-7/8")

Bore size: L – 11.73 mm (0.462")

Finish: clear lacquer

Mouthpiece: TR16C4

With gold brass bell: YTR-8345RG

With silver plate finish: YTR-8345RS/YTR-8345RGS

C Trumpets



YTR-8445S

YTR-8445

The Xeno Series C Trumpets are ideal for use in any performance. The brilliant tonal color and accurate intonation respond to the expressive ability of the performer.

Key=C

Bell: one piece yellow brass, 123 mm (4-7/8")

Bore size: L – 11.73 mm (0.462")

Finish: clear lacquer

Mouthpiece: TR16C4

With gold brass bell: YTR-8445G

With silver plate finish: YTR-8445S/YTR-8445GS

Custom Series Trumpets

Custom Models with Shining Individuality

Collaboration with the world's leading artists is essential for crafting Yamaha instruments. Yamaha tirelessly pursues the incorporation of artists' ideas or experiences to create instruments that enable musical expression at higher levels. Traditional techniques, the latest research, and collaboration of refined artists and expert craftsmen create the potential for ultimate performance.

Wayne Bergeron with Yamaha



YTR-8335LA



Developed in cooperation with Wayne Bergeron, the second-generation YTR-8335LA takes a significant evolutionary step forward. In addition to the French bead and side seam carried over from the first generation, the new model features a newly designed valve casing, heavy phosphor-bronze bottom caps, and water key inherited from the Xeno Artists Model. The result is an instrument that plays efficiently with ideal resistance and rich harmonics, making it an ideal choice for a wide range of musical genres.

YTR-8335LA

Key=B \flat
Bell: one piece yellow brass, 127 mm (5")
Bore size: ML – 11.65 mm (0.459")
Finish: gold lacquer
Mouthpiece: TR14B4

With silver plate finish: YTR-8335LAS

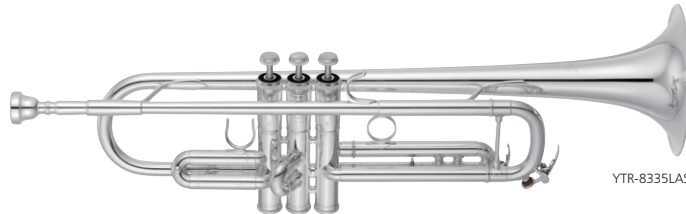

YTR-8335LAS



TRC-801E

Semi-hard case that can be carried in your hand, over your shoulder, or like a backpack.

Eric Miyashiro with Yamaha



YTR-8330EM



Eric Miyashiro has teamed up with Yamaha to develop a new EM model that retains the large bell with French bead and side seam of the preceding version while adding an updated valve casing, lead pipe, and phosphor-bronze bottom caps. These and other refinements, including a revised and perfectly matched mouthpiece, contribute to stunning tone and superb playability right through to the high register as well as extraordinary flexibility.

YTR-8330EM

Key=B \flat
Bell: one piece yellow brass, 134.4 mm (5-1/4")
Bore size: step bore* – ML
Finish: gold lacquer
Mouthpiece: EM1-MK2

* The main tuning slide has an L bore, the valve slides have an ML bore, and the pistons have an M bore. This helps to maintain smooth, consistent playability when all three valves are open or fingered in any combination.



TRC-8340EM

Semi-soft backpack style case has been designed specifically for EM model trumpets.

Side Seam

Side seaming is the process of placing the connection point on the lateral valve casing side in contrast to the conventional method of placing the connection point on the lower side of the bell. Side seam trumpets are characterized by a more open vibration.



YTR-8335LA

YTR-8330EM

Phosphor Bronze Parts

The pursuit of ideal tone and optimum playing balance led to the adoption of phosphor-bronze bottom caps. (The EM model also includes a phosphor-bronze 3rd tuning slide stopper screw)



Main Tuning Slide Brace

A unique tuning slide brace shape that reduces resistance when compared to conventional braces evens out resonance by minimizing variations in playing feel and resistance. The position of the brace has also been revised in the new model, to achieve optimum overall playability.

Custom Z Series Trumpets

The Legend Continues

The Z was born of Yamaha's long and close partnership with legendary trumpeter Bobby Shew. An incredibly versatile musician, Shew needed one efficient instrument that could scream out a powerful lead and play soft, mellow ballads. With the Z, he finally found an instrument that met all of his playing requirements.

Bobby Shew with Yamaha



YTR-8310Z



YTR-8310ZS



The YTR-8310Z has been completely redesigned down to the smallest details, such as a new valve casing, leadpipe, and other improvements for a wide pallet of tone colors, a huge dynamic range, and a great response from the lowest register to however high you can play.

YTR-8310Z

Key=B \flat

Bell: one piece yellow brass, 127 mm (5")

Bore size: step bore* – 11.3 mm (0.445")

Finish: gold lacquer

Mouthpiece: SHEW-JAZZ

With silver plate finish: YTR-8310ZS

* The YTR-8310Z features a "step bore" that is essential to the instrument's outstanding tone, pitch, and playability. The main tuning slide has a large bore, while all other slides and pistons have a medium bore.



TRC-801E

Semi-hard case that can be carried in your hand, over your shoulder, or like a backpack.

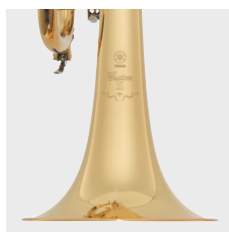

One-piece Side-seam Bell

A one-piece yellow-brass bell plays an important role in achieving bright tone and outstanding projection. The bell also features a side seam that passes through the points where tubing braces dampen vibration, for more open resonance. (LA/EM/Z Series)



Valve Casing for Powerful Tone

In order to produce the powerful, well-defined tone that today's jazz players demand, the conventional one-piece valve casing has been replaced with a two-piece design. This refinement adds weight to the instrument's tone while also increasing playing resistance. (LA/EM/Z Series)



French Bead Bell Rim

Unlike traditional methods that produce a round bell rim, the more advanced French bead technique results in a flat-dome rim shape that enhances feedback to the performer. (LA/EM/Z Series)



Water key rubber

The water key features a rubber that is designed to allow smooth breath flow, reducing resistance and improving high-note playability. (EM/Z Series)

Professional Model Trumpets

Perfect for All-Around Playing

Yamaha's professional medium-weight models are the perfect all-around trumpets. They're at home in any setting, from studio to big band, concert band, chamber group or orchestra. Yamaha offers several models to meet the needs of almost any player.

B \flat Trumpets



YTR-6335

YTR-6335

The YTR-6335 features a medium-large bore and a yellow-brass bell for a big sound with clear projection. It has the kind of flexibility needed for playing in a quintet or in the studio but enough tonal power for lead or orchestral work.

Key=B \flat

Bell: one piece yellow brass, 123 mm (4-7/8")

Bore size: ML – 11.65 mm (0.459")

Finish: gold lacquer

Mouthpiece: TR14B4

With silver plate finish: YTR-6335S



YTR-6345GS

YTR-6345G

The YTR-6345 offers a large-sized bore with a gold-brass bell for a warm, rich, commanding tone. Both are ideal for those who need versatility in their horn and are looking for an instrument that will play and sound just right in any group or setting.

Key=B \flat

Bell: one piece gold brass, 123 mm (4-7/8")

Bore size: L – 11.73 mm (0.462")

Finish: gold lacquer

Mouthpiece: TR14B4

With silver plate finish: YTR-6345GS



YTR-6335RC

YTR-6335RC

The YTR-6335RC features a two-piece gold brass bell with solder inside the rim, for an open, projecting sound. The reversed tuning slide creates a free blowing resistance, comfortable enough even for long grueling studio sessions. With its exceptionally well balanced playability, this trumpet is ideal for a wide range of musical genres.

Key=B \flat

Bell: two piece gold brass, 123 mm (4-7/8")

Bore size: ML – 11.65 mm (0.459")

Finish: gold lacquer

Mouthpiece: TR14B4



Reversed tuning slide enables easy blowing and smooth and comfortable feel in playing.

Intermediate Model Trumpets

There Are No Shortcuts in Pursuit of Musical Excellence

Yamaha's Intermediate Trumpets are high-quality instruments crafted using many of the technologies developed in producing our top-of-the-line professional models. Using a new production method we've created a two-piece bell that blows freely with rich, wide-ranging tone color. Tuning slides also utilize a new production method that produces an instrument higher in quality and easier to play.

B \flat Trumpets



YTR-4335GII

YTR-4335GII

The YTR-4335GII features a gold-brass bell that produces a richer, wider range of tonal colors. Durable yet light, the bell promotes easy endurance while playing. The richness of tone quality and freeblowing feel make this trumpet a great vehicle for those players looking to take their performance to the next level.

Key=B \flat

Bell: two piece gold brass, 123 mm (4-7/8")

Bore size: ML – 11.65 mm (0.459")

Finish: gold lacquer

Mouthpiece: TR11B4

With silver plate finish: YTR-4335GSII



TRC-401E

Semi-hard case that can be carried in your hand, over your shoulder, or like a backpack.

C/B \flat Trumpets



YTR-4435SII

YTR-4435II

Incorporating know-how and technologies developed in the production of our high-end professional series trumpets, the YTR-4435II offers remarkable sound and playability. The tuning slide features a brace that brings more focus to the sound. Pitched in C, the instrument can be converted to B \flat for greater versatility.

Key=C/B \flat

Bell: two piece yellow brass, 123 mm (4-7/8")

Bore size: ML – 11.65 mm (0.459")

Finish: gold lacquer

Mouthpiece: TR11B4

Extra tuning slides to convert to B \flat

With silver plate finish: YTR-4435SII



The YTR-4435II with B \flat slides

Student Model Trumpets

Start Off on the Right Note—with the Right Trumpet

Yamaha's Student Model trumpet also owes much of its basic design to our professional series. Beginners will find it fun and easy to play and sound good on. This will help them learn to play in tune with a rich solid sound while establishing a strong musical foundation. Design focused first and foremost on creating a free blowing instrument, but we also thought long and hard about weight balance. An adjustable third valve trigger is added to accommodate different sized hands helping you master proper playing form. Highly durable pistons are made of monel alloy and soldered tuning slides offer extended durability and richer tone.

B \flat Trumpets



YTR-3335

The YTR-3335 is designed for players who are serious about their sound and ready to move up to a higher-grade instrument. Sharing the free blowing character of the YTR-2330, it plays smooth and comfortably with a matured, appealing tone. It also features a reversed leadpipe with a single brace for smoother, freer blowing.

Key=B \flat

Bell: two piece yellow brass, 123 mm (4-7/8")

Bore size: ML – 11.65 mm (0.459")

Finish: gold lacquer

Mouthpiece: TR11B4

With silver plate finish: YTR-3335S

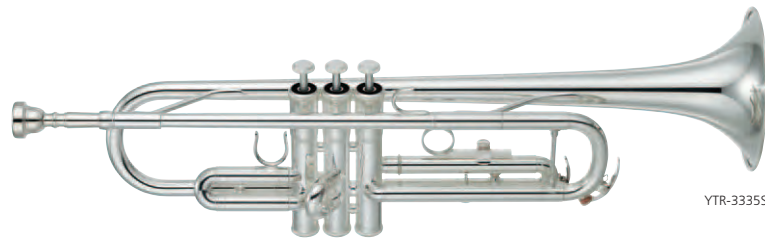

TRC-201EII

Semi-hard case with backpack style shoulder straps and carrying handles.



Reversed tuning slide enables easy blowing and smooth and comfortable feel in playing. (YTR-3335 only)

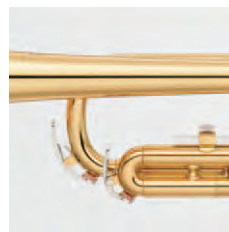

Third valve equipped with a water-key.



YTR-2330

YTR-2330

The two-piece bell of the YTR-2330 is crafted using state-of-the-art production methods, delivering a consistent, vibrant tone. The balanced weight and addition of an adjustable third valve trigger allows for a natural hand position and promotes proper playing technique, while the water key on the third valve slide adds to the ease of use and over-all playability of the instrument.

Key=B \flat

Bell: two piece yellow brass, 123 mm (4-7/8")

Bore size: ML – 11.65 mm (0.459")

Finish: gold lacquer

Mouthpiece: TR11B4

With silver plate finish: YTR-2330S



YTR-2330S



TRC-100EII

Bag style case with shoulder strap.

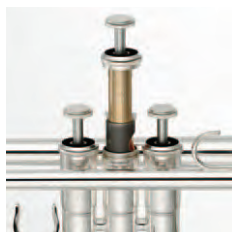

New piston, piston caps and buttons

Highly durable monel alloy pistons as well as newly designed piston buttons and bottom caps help lengthen the life of the instrument while also maximizing sound quality.

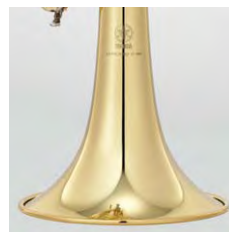

Lightweight yellow brass bell

The newly redesigned, durable yet light two-piece bell is made of yellow brass for optimal playability and to promote good technique and endurance.

Specialized Instruments for Unique Compositions

Yamaha manufactures a wide array of instruments to meet the needs of specific styles of musical performance. Piccolo trumpets have a brilliant sound for Baroque or modern pieces. Rotary trumpets are indispensable for performances of German or Viennese classical or Romantic compositions. Flugelhorns will fill the hall with an extremely soft and mellow tone. And cornets demonstrate their ability in more rapid passages.

Yamaha collaborated with top artists performing all over the world stage in order to deliver this uncompromising range of instruments.



B \flat /A Piccolo Trumpets

A Sound That Will Go Down in History

Although piccolo trumpets are generally used to play the difficult and high first trumpet parts from the Baroque era, more and more modern composers are creating contemporary pieces for these exciting instruments. Yamaha piccolo trumpets are easy to play and offer a beautiful sound with excellent intonation.



Acclaimed soloist Jens Lindemann has been the consultant for the Yamaha rotary piccolo trumpet, and Yamaha took a time to develop for 20 years. The new YTR-988 incorporates many original ideas that result in improved interval control, ease of playability and tubing with a completely original shape.

YTR-988 — Custom Model —

The YTR-988 is a custom rotary piccolo trumpet that provides stable playability in addition to proper resistance and accurate intonation. The instrument can convert from the key of B \flat to the key of A simply by switching the leadpipe.

Key=B \flat /A
 Bell: one piece yellow brass, 97.9 mm (3-15/16")
 Bore size: S – 10.38 mm (0.409")
 Finish: silver plate
 Accessories: 2 leadpipes for key of B \flat and A
 Mouthpiece: TR11A5



YTR-988

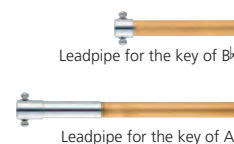

Leadpipe for the key of B \flat

Leadpipe for the key of A



Rotary Valve "Light-Touch" Mechanism

New rotary valves allow excellent playability without stress. A light valve action allows the player to concentrate on musical expression.



Adjustable Thumbhook (Movable Fingerhook)

We believe that "easy to hold means easy to play" and have adopted an adjustable thumbhook, allowing for adjustment of the orientation of the fixing ring or positional changes to suit the style of the player. This feature allows more stability when holding the instrument.

YTR-9835 — Custom Model — *MalonePipe*

The YTR-9835 is a custom piccolo trumpet with four piston valves, resulting in a beautiful rich tone. YTR-9835 comes 4 leadpipes. Two leadpipes have trumpet mouthpiece receivers in B \flat and A while the other two have cornet mouthpiece receivers in B \flat and A.

Key=B \flat /A
 Bell: one piece yellow brass, 101 mm (4")
 Bore size: M – 11.3 mm (0.445")
 Finish: silver plate
 Accessories: 4 leadpipes; B \flat and A for trumpet shank, and B \flat and A for cornet shank, and a leadpipe pouch.
 Mouthpiece: TR11A5, CR11A4

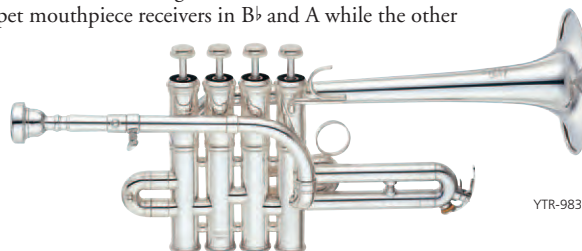

YTR-9835

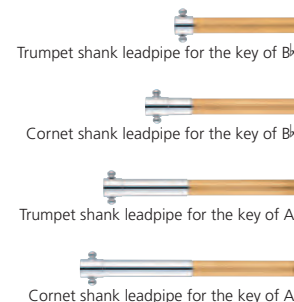

Trumpet shank leadpipe for the key of B \flat

Cornet shank leadpipe for the key of B \flat

Trumpet shank leadpipe for the key of A

Cornet shank leadpipe for the key of A

YTR-9825 — Custom Model — *MalonePipe*

The YTR-9825 is a custom piccolo trumpet with three piston valves to create a light bright tone. The trigger is adjustable and easy to hold. YTR-9825 comes 4 leadpipes. Two leadpipes have trumpet mouthpiece receivers in B \flat and A while the other two have cornet mouthpiece receivers in B \flat and A.

Key=B \flat /A
 Bell: one piece yellow brass, 101 mm (4")
 Bore size: M – 11.3 mm (0.445")
 Finish: silver plate
 Accessories: 4 leadpipes; B \flat and A for trumpet shank, and B \flat and A for cornet shank, and a leadpipe pouch.
 Mouthpiece: TR11A5, CR11A4



YTR-9825



Leadpipe pouch

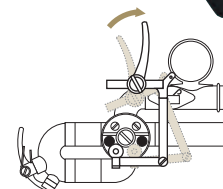

Rotary System of YTR-9825

If the trigger is pulled when the third piston is depressed, the note can be reduced by a whole tone to expand the low register.

YTR-6810 — Professional Model —

This professional piccolo trumpet has a smaller bell and bore size, producing a sound more suitable for solo or chamber music. This model has four piston valves and B \flat /A exchangeable leadpipes.

Key=B \flat /A
 Bell: one piece yellow brass, 94 mm (3-3/4")
 Bore size: S – 10.5 mm
 Finish: gold lacquer
 Accessories: 2 leadpipes for key of B \flat and A
 Mouthpiece: TR14A4a
 With silver plate finish: YTR-6810S



YTR-6810S

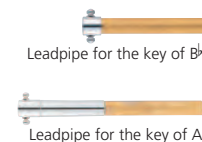

Leadpipe for the key of B \flat

Leadpipe for the key of A

E, E \flat & D Trumpets

Hitting the High Notes

With their brilliant sound, clear and crisp attack, and excellent control in the high register, these trumpets were originally used mainly for performance of Baroque music. But now they are increasingly played as an alternative to B \flat and C trumpets, especially for hitting treacherous passages in the upper registers.

E/E \flat Trumpets

YTR-9635 — Custom Model —

This heavyweight model combines a full and robust tone with superior playability. Performers can easily transition between E and E \flat keys by exchanging the bell and first and third valve slides.

Key=E/E \flat

Bell: one piece yellow brass, 123 mm (4-7/8")

Bore size: ML – 11.65 mm (0.459")

Finish: silver plate

Accessories: E \flat Bell, first and third valve slides

Mouthpiece: TR14B4

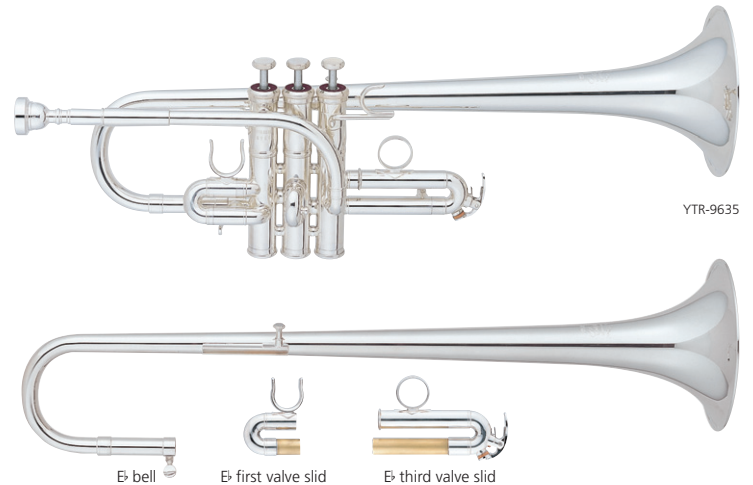

E \flat /D Trumpets

YTR-9636 — Custom Model —

The YTR-9636 model has a rich and attractive tone and is widely used in both solo and orchestral performance due to its natural ability to shift from C. It has a newly designed leadpipe with a unique shape. Transitioning between D and E \flat involves changing the main tuning slide and first and third valve slides rather than by changing the bell.

Key=E \flat /D

Malone Pipe

Bell: one piece yellow brass, 123 mm (4-7/8")

Bore size: ML – 11.65 mm (0.459")

Finish: silver plate

Accessories: D main tuning slide and first and third valve slides

Mouthpiece: TR14B4

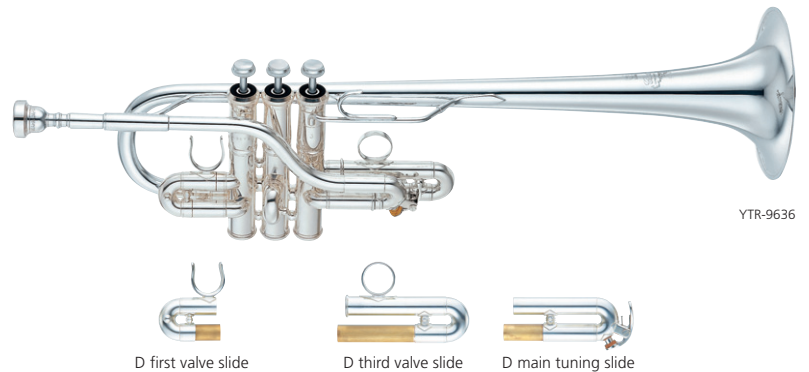

YTR-9610 — Custom Model —

The YTR-9610 is a custom-made E \flat /D trumpet that has proper resistance and accurate intonation for performers to play a full variety of musical genres from solo or chamber music to full orchestral compositions. The trumpet's lightweight design provides an attractive combination of agile response and pleasant playing. Switching between the keys of E \flat and D involves exchanging the bell and the first and third valve slides.

Key=E \flat /D

Bell: one piece yellow brass, 120 mm (4-3/4")

Bore size: M – 11.3 mm (0.445")

Finish: silver plate

Accessories: D bell and first and third valve slides

Mouthpiece: TR14B4

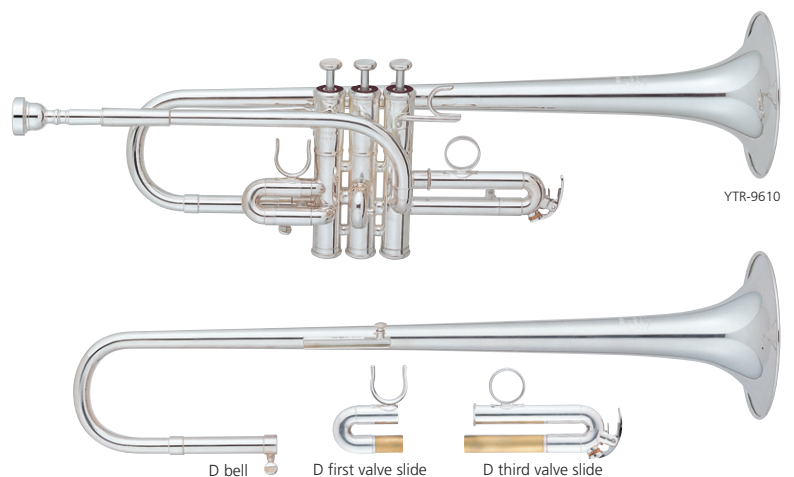

YTR-6610S — Professional Model —

The YTR-6610S is a lightweight professional model that continues Yamaha's tradition of excellence by providing agile response and accurate intonation. Switching between the key of E \flat and D involves exchanging the main tuning slide and the first and third valve slides.

Key=E \flat /D

Bell: one piece yellow brass, 120 mm (4-3/4")

Bore size: M – 11.3 mm (0.445")

Finish: silver plate

Accessories: D main tuning slide and first and third valve slides

Mouthpiece: TR14B4

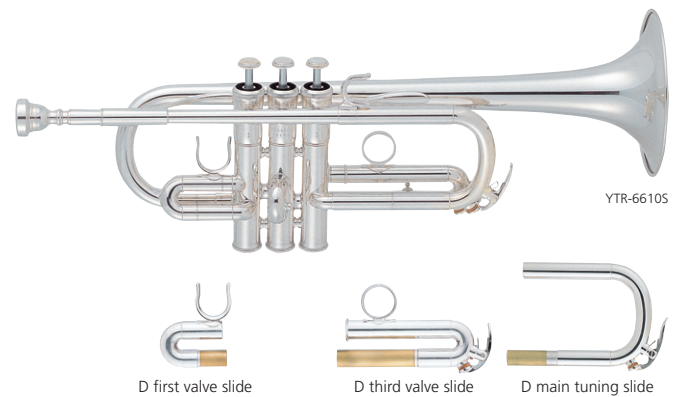

G/F Trumpet

Expressing Your Unique Style

This custom trumpet responds to a wide range of expressive styles and has a brilliant high register. Performers can switch the instrument from the key of G to the key of F by exchanging the bell and valve slides.

YTR-9710 — Custom Model —

Key=G/F

G Bell: one piece yellow brass, 101 mm (4")

F Bell: one piece gold brass, 110 mm (4-1/3")

Bore size: M – 11.3 mm (0.445")

Finish: silver plate

Accessories: F bell and first and third valve slides

Mouthpiece: TR14A4a

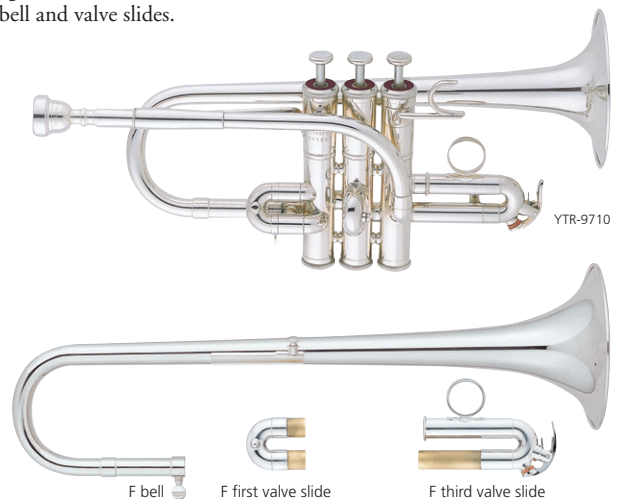

Herald Trumpet

A Sound That Will Tug at Your Heartstrings

This herald (fanfare) trumpet will add a touch of glamour to ceremonies and events with its unique appearance and brilliant, well-defined tone. Playing resistance and projection have been optimized for outdoor playing, while improved balance, a newly designed water key on the bell U tube, and other refinements are built on Yamaha's extensive experience at ceremonies and events around the globe.

YTR-6335F — Professional Model —

Key=B \flat

Bell: two piece yellow brass, 123 mm (4-7/8")

Bore size: ML – 11.65 mm (0.459")

Finish: gold lacquer

Mouthpiece: TR14B4

With silver plate finish: YTR-6335FS

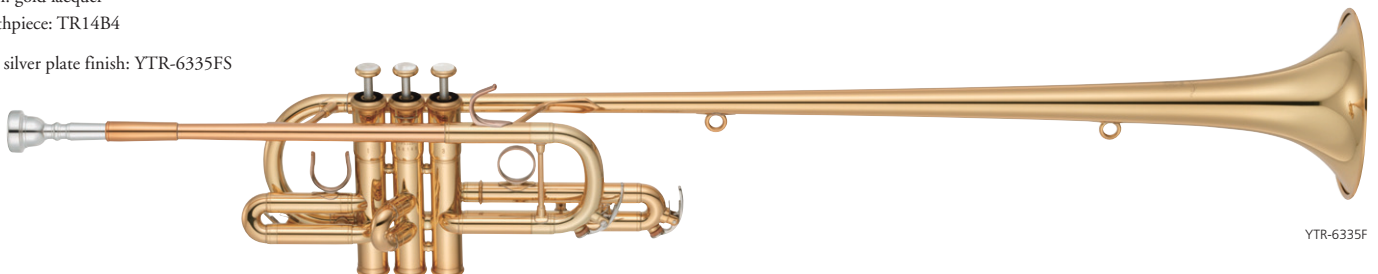

Rotary Trumpets

Known the World Over

Following German tradition, Yamaha's innovative new rotary trumpet produces an expressive tone and superior playability. With its warmth and depth, the instrument resonates naturally with other instruments, even in a full orchestra.



Markus Bebek, first trumpet with the Frankfurt Opera Orchestra, acts as Yamaha's new rotary trumpet consultant. Yamaha's know-how applied to Bebek's ideas led to the birth of a new era in sound balance and creation of a tone that is both brilliant and soft.

YTR-938FFMS/YTR-938FFMGS — Custom Model —

Yamaha's newly designed YTR-938FFMS has been developed in collaboration with musicians from a Frankfurt atelier*. Yamaha's new "light-touch mechanism" has been applied to the rotary valves, resulting in a highly responsive "lever action."

*Frankfurt atelier moved to Hamburg in April 2009.

Key=B \flat

Bell: one piece yellow brass (YTR-938FFMS), one piece gold brass (YTR-938FFMGS), 138 mm (5-7/16")

Bore size: M – 11.24 mm (0.442")

Finish: silver plate

Mouthpiece: TR16E4



YTR-938FFMS

YTR-948FFMS/YTR-948FFMGS — Custom Model —

Like the YTR938FFMS, the newly designed YTR-948FFMS rotary C trumpet incorporates many innovations.

Yamaha's new "light-touch mechanism" has been applied to the rotary valves, and a high C key has been added as a standard feature on the tuning slide.

Key=C

Bell: one piece yellow brass (YTR-948FFMS), one piece gold brass (YTR-948FFMGS), 130 mm (5-1/8")

Bore size: M – 11.24 mm (0.442")

Finish: silver plate

Mouthpiece: TR16E4

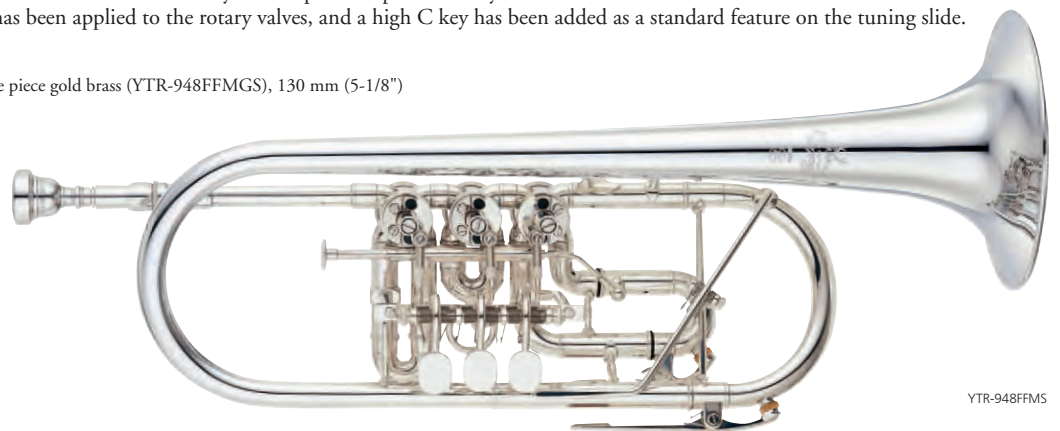

YTR-948FFMS



Rotary Valve "Light-Touch Mechanism"

New rotary valves allow excellent playability without stress on musicians' fingers. The light valve action allows the player to concentrate on musical expression.

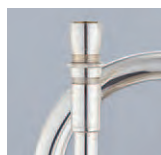

Adjustable Mouthpiece Receiver

The space between the mouthpiece and the leadpipe can be adjusted to suit a player's preferences in resistance and playability.

Flugelhorns

A Deep Resonance, Sweet and Beautiful

Flugelhorns have a soft, mellow, dark sound with beautiful lyrical qualities; they are especially favored for jazz ballads. Yamaha has overcome the intonation challenges typically associated with older flugelhorns and offer a very comfortable response.

YFH-8310Z — Custom Model — *MalonePipe*

The YFH-8310Z combines the tonal richness and depth of character of the older traditional flugels with the easy playability and superb intonation made possible by high-tech engineering. Inspired by legendary artist Bobby Shew, the Z features the perfect amount of air resistance to let you color the sound—your sound—exactly the way you want to. And it slots so nicely in the upper register you'll forget you're playing a flugelhorn.

Key=B \flat

Bell: one piece yellow brass, 151.8 mm (6")

Bore size: S – 10.5 mm (0.413")

Finish: clear lacquer, third valve slide trigger

Mouthpiece: SHEW-FH

With gold brass bell : YFH-8310ZG

With silver plate finish : YFH-8310ZS/8310ZGS

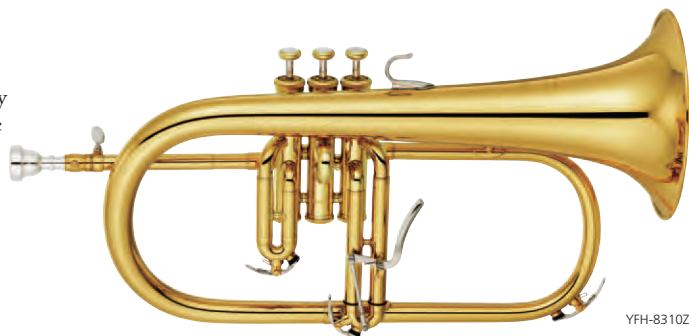

YFH-8310Z

YFH-8315G — Custom Model — *MalonePipe*

The YFH-8315G has been developed in collaboration with musicians from a New York and Los Angeles atelier. The new generation instrument uses a two-piece bell, etc to deliver a soft tone with outstanding presence.

Key=B \flat

Bell: two piece gold brass, 151.8 mm (6")

Bore size: S – 10.5 mm (0.413")

Finish: clear lacquer, third valve slide trigger

Mouthpiece: FH14F4

With silver plate finish: YFH-8315GS



YFH-8315G

New Trigger System

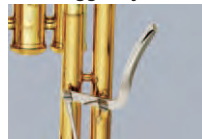

The newly designed third valve slide trigger is more ergonomic and will accommodate a wider range of hand sizes.

New Leadpipe Design



YFH-8310Z



YFH-8315G

New flugelhorn I features a newly designed leadpipe, outer leadpipe area and a new connection brace between the leadpipe and the valve casing.

YFH-631G — Professional Model —

The YFH-631G is easy to play in a traditional style and has a broad and rich tonal range. Proper intonation can be achieved by adjusting the third valve slide trigger.

Key=B \flat

Bell: two piece gold brass, 151.8 mm (6")

Bore size: M – 11 mm (0.433")

Finish: clear lacquer, third valve slide trigger

Mouthpiece: FH11F4

With silver plate finish: YFH-631GS



YFH-631G



YFH-631GS

Cornets

In Constant Pursuit of Perfect Music

The Yamaha cornet responds to the varied demands of a performer. Yamaha's long experience in the manufacture of instruments can be seen in every detail of these cornets. Artists performing all over the world have been in constant communication with Yamaha's research and development team to further advance the musicality of these horns.

Neo B \flat & E \flat Models



The Neo cornet was developed in close cooperation with internationally renowned artists Russell Gray and Phillip McCann. A sublime fusion of traditional Yamaha craftsmanship with state-of-the-art technology has resulted in a sound that ideally meets the musical requirements of British brass bands.

YCR-8335

The Neo cornet range provides a greater breadth of tone and expressive emotion in an enriched sound world. The use of gold brass for the lead-pipe, connection tube and main tuning slide give these new cornets a rich, flexible sound and excellent response in the higher register.

Key=B \flat

Bell: one piece yellow brass, 125.5 mm (5")

Bore size: L – 11.9 mm (0.469")

Finish: clear lacquer, first and third valve slide triggers

Mouthpiece: CR16E (S)

With gold brass bell: YCR-8335G

With silver plate finish: YCR-8335S/8335GS



YCR-8335

YCR-8620S

The Neo E \flat cornet has been designed to provide comfort and security when performing in the high register, while maintaining a beautiful warm sound in any range. The intonation is incredibly accurate and the cornet plays with an even, nimble response and is engraved with Neo on the bell.

Key=E \flat

Bell: one piece yellow brass, 120 mm (4-3/4")

Bore size: M – 11.3 mm (0.445")

Finish: silver plate

Mouthpiece: CR6B4 (L)

With clear lacquer finish: YCR-8620

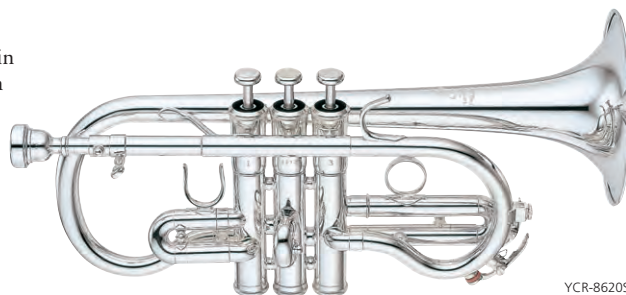

YCR-8620S

Custom C Model

Incorporating input from consultant John Hagstrom from the Chicago Symphony Orchestra, the Custom cornet features french bead wire and side seams. Trumpet shanks allow for smooth exchanging from trumpet to cornet. Yamaha's design supports the performer by creating a strong, brilliant, complex sound in a volume that is required during orchestral performances.

YCR-9435 *Malone's Pipe*

Key=C

Bell: one piece yellow brass, 123 mm (4-7/8")

Bore size: ML – 11.65 mm (0.459")

Finish: silver plate

Mouthpiece: TR16C4



YCR-9435

Professional B \flat Models

The YCR-6330II is a high-performance model with a one-piece yellow-brass bell, resulting in smooth continuous airflow and a deep rich resonance.

YCR-6330II

Key=B \flat

Bell: one piece yellow brass, 119 mm (4-2/3")

Bore size: L – 11.73 mm (0.462")

Finish: clear lacquer

Mouthpiece: CR14E (S)

With silver plate finish: YCR-6330SII



YCR-6330II

Intermediate B \flat Models

YCR-4330GII

The YCR-4330GII which includes a newly designed rounded leadpipe in combination with a ML-Bore offers the typical cornet sound with a very easy response. The modified two-piece gold brass bell with ideal thickness enables the player to create a round and warm tone.

Key=B \flat

Bell: two piece gold brass, 119 mm (4-2/3")

Bore size: ML – 11.65 mm (0.459")

Finish: gold lacquer

Mouthpiece: CR11E4 (S)

With silver plate finish: YCR-4330GSII



YCR-4330GII

Student B \flat & E \flat Models

We've incorporated what we've learned from our high-end professional models into a new line of Student Cornets that offer remarkably improved tone and free blowing. All instruments utilize a two-piece bell crafted with a newly developed production method. They also feature well-balanced designs that make them easier to hold and improve durability. Pistons are made of the monel alloy and soldered tuning slides offer extended durability and richer tone.

YCR-2330III

The YCR-2330III is an excellent introductory model that features a "Shepherd's Crook" bell style, a rounded leadpipe and a ML (medium-large) bore for smooth and light playability with a soft, warm tone. An adjustable third valve trigger accommodates different sized hands helping the player develop proper playing technique.

Key=B \flat

Bell: two piece yellow brass, 119 mm (4-2/3")

Bore size: ML – 11.65 mm (0.459")

Finish: gold lacquer

Mouthpiece: CR11E4 (S)

With silver plate finish: YCR-2330SIII



YCR-2330III

YCR-2310III

The YCR-2310III is an excellent introductory model that features a rounded leadpipe and ML (medium-large) bore for smooth and light response with a soft, warm tone. An adjustable third valve trigger accommodates different sized hands helping the player develop proper playing technique.

Key=B \flat

Bell: two piece yellow brass, 119 mm (4-2/3")

Bore size: ML – 11.65 mm (0.459")

Finish: gold lacquer

Mouthpiece: CR11C4 (L)

With silver plate finish: YCR-2310SIII



YCR-2310III

YCR-2610SIII

The YCR-2610SIII beginner's E \flat cornet has a movable fingerhook that can be adjusted for smaller hands and allows the student to learn a correct fluid method of playing.

Key=E \flat

Bell: two piece yellow brass, 119 mm (4-2/3")

Bore size: ML – 11.65 mm (0.459")

Finish: silver plate

Mouthpiece: CR7D4d (S)



YCR-2610SIII



New piston, piston caps and buttons

Highly durable monel alloy pistons as well as newly designed piston buttons and bottom caps help lengthen the life of the instrument while also maximizing sound quality.



Lightweight yellow brass bell

The newly redesigned, durable yet light two-piece bell is made of yellow brass for optimal playability and to promote good technique and endurance.



Round shape lead pipe

The redesigned rounded leadpipe give this instrument a smooth and light response and a warm tone quality.

Yamaha Trumpet Mouthpieces

All Yamaha brass mouthpieces have been designed in cooperation with the world's top players and are produced on space-age computer lathes, virtually guaranteeing that every mouthpiece with the same model number will play, sound and feel precisely the same. We offer four different series to suit any playing requirements.



Standard Series

Yamaha's Standard Series mouthpieces allows for smooth attack, secure control and easy playability. They offer a perfect weight balance for all-around usage and are available in a wide variety of options for inner diameter, thickness, cup depth, throat dimensions and backbore width.



GP Series

The GP Series are heavyweight with a shape ideal for players who want a strong, focused sound. The rim, cup and inner bore are gold-plated for superior projection and smooth response.

Trumpet—Standard Series

Model No.	Inner Diameter	Contour	Thickness	Cup Depth	Throat	Backbore	Approximate Size Equivalent
5A4	15.90 mm	semi-flat	thick	shallow	3.65 mm	narrow	Bob Reeves OES 69
6A4a	15.90 mm	semi-flat	thick	shallow	3.65 mm	narrow	Schilke 6A4a
7A4	16.24 mm	semi-flat	thick	shallow	3.65 mm	narrow	Purviance 4 (4*D4)
7B4	16.08 mm	semi-flat	thick	semi-shallow	3.72 mm	standard	Schilke 7B4
8C4	16.19 mm	semi-flat	standard	standard	3.65 mm	semi-narrow	Bach 10 1/2C
9C4	16.28 mm	semi-flat	standard	standard	3.65 mm	semi-narrow	Bach 7C, smaller rim diameter
11A4	16.46 mm	semi-flat	semi-thick	shallow	3.65 mm	semi-narrow	Bach 7E
11A5	16.38 mm	semi-flat	thick	shallow	3.65 mm	semi-wide	Bach 7EW
11B4	16.46 mm	semi-flat	standard	semi-shallow	3.65 mm	semi-narrow	Bach 7D
11	16.32 mm	standard	semi-thick	standard	3.72 mm	standard	Schilke 11
11C4	16.46 mm	semi-flat	standard	standard	3.65 mm	semi-narrow	Bach 7C, Giardinelli 7C
13A4a	16.20 mm	semi-flat	thick	shallow	3.65 mm	narrow	Schilke 13A4a
13B4	16.63 mm	semi-flat	standard	semi-shallow	3.65 mm	semi-narrow	Bach 6C
13C4	16.50 mm	semi-flat	standard	standard	3.65 mm	semi-narrow	Bach 6B
14A4a	16.68 mm	semi-flat	semi-thick	shallow	3.65 mm	narrow	Schilke 14A4a, Giardinelli 6S
14B4	16.85 mm	semi-flat	standard	semi-shallow	3.65 mm	semi-narrow	Bach 3C, Schilke 15B
14C4	16.88 mm	semi-flat	standard	standard	3.65 mm	semi-narrow	Bach 5C, Giardinelli 5C
14D4	16.80 mm	semi-flat	standard	semi-deep	3.65 mm	semi-narrow	Bach 5B
14E4	16.84 mm	semi-flat	semi-thick	deep	3.88 mm	wide	Bach 3C rim, very deep cup
15B4	16.96 mm	semi-flat	standard	semi-shallow	3.65 mm	semi-narrow	Bach 2C, shallower cup
15C4	16.98 mm	semi-flat	standard	standard	3.65 mm	semi-narrow	Bach 2C
15E4	16.92 mm	semi-flat	semi-thick	deep	3.88 mm	wide	Bach 2C rim, very deep cup
16C4	17.00 mm	semi-flat	standard	standard	3.65 mm	semi-narrow	Bach 1 1/2C
16D	17.14 mm	standard	standard	semi-deep	3.65 mm	semi-narrow	Bach 1 1/2C, deeper cup
16E4	17.14 mm	semi-flat	semi-thick	deep	3.88 mm	wide	Bach 1 1/2C rim, very deep cup
17B4	17.30 mm	semi-flat	standard	semi-shallow	3.65 mm	semi-narrow	Bach 1 1/4C
17C4	17.30 mm	semi-flat	standard	standard	3.65 mm	semi-narrow	Bach 1C
17D4	17.30 mm	semi-flat	standard	semi-deep	3.65 mm	semi-narrow	Bach 1C, deeper cup
18C4	17.42mm	semi-flat	standard	standard	3.65 mm	semi-narrow	Bach 1

Trumpet—GP Series

Model No.	Inner Diameter	Contour	Thickness	Cup Depth	Throat	Backbore	Approximate Size Equivalent
11B4-GP	16.46 mm	semi-flat	standard	semi-shallow	3.65 mm	semi-narrow	Bach 7D
14A4a-GP	16.68 mm	semi-flat	semi-thick	shallow	3.65 mm	semi-narrow	Schilke 14A4a, Giardinelli 6S
14B4-GP	16.85 mm	semi-flat	standard	semi-shallow	3.65 mm	semi-narrow	Bach 3C, Schilke 15B
14C4-GP	16.88 mm	semi-flat	standard	standard	3.65 mm	semi-narrow	Bach 5C, Giardinelli 5C
16C4-GP	17.00 mm	semi-flat	standard	standard	3.65 mm	semi-narrow	Bach 1 1/2C
17C4-GP	17.30 mm	semi-flat	standard	standard	3.65 mm	semi-narrow	Bach 1C

■ Cornet—Standard Series (Short Shank)

Model No.	Inner Diameter	Contour	Thickness	Cup Depth	Throat	Backbore	Approximate Size Equivalent
7D4d	16.24 mm	semi-flat	thick	semi-deep	4.10 mm	semi-wide	Denis Wick S
8D2	16.36 mm	semi-round	standard	semi-deep	4.10 mm	wide	Denis Wick S, larger rim diameter
9E	16.44 mm	standard	standard	deep	4.50 mm	semi-wide	Denis Wick 5
11C4	16.46 mm	semi-flat	standard	standard	3.65 mm	semi-narrow	Bach 7C
11E4	16.46 mm	semi-flat	standard	deep	4.20 mm	standard	Denis Wick 4B
13E4	16.70 mm	semi-flat	standard	deep	4.50 mm	standard	Denis Wick 4
14E	16.86 mm	standard	standard	deep	3.98 mm	standard	Denis Wick 3, deep U cup
16E	17.05 mm	standard	standard	deep	3.98 mm	standard	Denis Wick 2, deep U cup

■ Cornet—Standard Series (Long Shank)

Model No.	Inner Diameter	Contour	Thickness	Cup Depth	Throat	Backbore	Approximate Size Equivalent
6B4	15.65 mm	semi-flat	semi-thick	semi-shallow	3.76 mm	standard	Bach 17C
7A4	16.24 mm	semi-flat	thick	shallow	3.65 mm	standard	Purviance 4 (4*D4)
9C4	16.28 mm	semi-flat	standard	standard	3.65 mm	standard	Bach 7C, smaller rim diameter
11A4	15.99 mm	semi-flat	standard	shallow	3.65 mm	semi-narrow	Schilke 11AX
11B4	16.64 mm	semi-flat	standard	shallow	3.65 mm	semi-wide	Bach 7E
11C4	16.46 mm	semi-flat	standard	standard	3.65 mm	standard	Bach 7C, Giardinelli 7C
13B4	16.63 mm	semi-flat	standard	semi-shallow	3.65 mm	standard	Bach 6C
14A4a	16.68 mm	semi-flat	standard	shallow	3.65 mm	standard	Schilke 14A4X
14B4	16.85 mm	semi-flat	standard	semi-shallow	3.65 mm	standard	Bach 3C, Schilke 15B
15C4	16.98 mm	semi-flat	standard	standard	3.65 mm	standard	Bach 2C
16C4	17.00 mm	semi-flat	standard	standard	3.65 mm	standard	Bach 1 1/2C
17C4	17.30 mm	semi-flat	standard	standard	3.65 mm	standard	Bach 1C

■ Cornet—GP Series (Short Shank)

Model No.	Inner Diameter	Contour	Thickness	Cup Depth	Throat	Backbore	Approximate Size Equivalent
14E-GP	16.86 mm	standard	standard	deep	3.98 mm	standard	Denis Wick 3, deep U cup
16E-GP	17.05 mm	standard	standard	deep	3.98 mm	standard	Denis Wick 2, deep U cup

■ Flugelhorn—Standard Series

Model No.	Inner Diameter	Contour	Thickness	Cup Depth	Throat	Backbore	Approximate Size Equivalent
11F4	16.46 mm	semi-flat	standard	standard	3.80 mm	standard	Bach 7FL
13F4	16.66 mm	semi-flat	standard	standard	4.30 mm	standard	Giardinelli 7FL
14F4	16.76 mm	semi-flat	standard	standard	4.30 mm	standard	Giardinelli 7FL, larger rim diameter
16F4	17.00 mm	semi-flat	standard	deep	4.30 mm	standard	Giardinelli 3FL
17F4	17.22 mm	semi-flat	standard	deep	4.50 mm	standard	Giardinelli 3FL, larger rim diameter

■ Flugelhorn—GP Series

Model No.	Inner Diameter	Contour	Thickness	Cup Depth	Throat	Backbore	Approximate Size Equivalent
14F4-GP	16.76 mm	semi-flat	standard	standard	4.30 mm	standard	Giardinelli 7FL, larger rim diameter

Signature Series Mouthpieces

For years many of the greatest talents in the world have been going to Yamaha's research and development centers to work with design experts who create their dream mouthpieces. Originally these mouthpieces were produced only for the personal use of the individual artists. But now, after numerous requests from their colleagues and students, Yamaha has made these special designs available to all.

■ Signature Series

Artist		Model No.	Inner Diameter	Contour	Thickness	Cup Depth	Throat	Backbore
Allen Vizzutti	for Trumpet	VIZZUTTI	16.67 mm	semi-flat	semi-thick	shallow	3.56 mm	narrow
Bobby Shew	for Trumpet	SHEW-LEAD	16.54 mm	semi-round	semi-thick	shallow	3.56 mm	narrow
	for Trumpet	SHEW-JAZZ	16.85 mm	semi-round	semi-thick	standard	3.65 mm	standard
	for Flugelhorn	SHEW-FH	16.54 mm	semi-round	semi-thick	standard	4.40 mm	long taper
Eric Miyashiro	for Trumpet	EM1-MK2	16.02 mm	semi-round	thin	shallow	3.65 mm	narrow
	for Trumpet	EM2-MK2	16.22 mm	semi-round	thin	shallow	3.65 mm	narrow
	for Flugelhorn	EM-FH	16.06 mm	semi-flat	thin	standard	4.40 mm	long taper
Eric Aubier	for Trumpet	TR-AUBIER-S	17.03 mm	semi-flat	standard	standard	3.80 mm	standard
Mark Gould	for Trumpet	MG	17.30 mm	standard	standard	semi-shallow	3.88 mm	standard
Pierre Dutot	for Cornet	CR-DUTOT-S	16.90 mm	standard	standard	deep	3.99 mm	wide
	for Cornet	CR-DUTOT-L	16.95 mm	standard	standard	shallow	3.72 mm	standard
	for Flugelhorn	FH-DUTOT	17.20 mm	semi-flat	standard	deep	3.99 mm	narrow
Thomas Hooten	for Trumpet	TR-HOOTEN	17.36 mm	semi-flat	standard	semi-shallow	3.8 mm	semi-wide



What Artists are Saying About Yamaha Trumpets...



Eric Aubier (France)
International Soloist.

"Yamaha trumpets are technically superior and contain the potential for a wide range of tonal colors and nuances. They are not artistic on their own but offer you a tool to express your own artistry."



Wayne Bergeron (US)

One of the Most Sought-After West Coast Studio Players.

"Since my line of work covers a lot of ground musically, I need an instrument that responds to these needs. The YTR-8335LA is the most versatile B♭ trumpet I have ever played. It delivers the full spectrum of tone colors needed to get the job done from the scoring stage to soaring over a big band."



Jeroen Berwaerts (Belgium)

International Soloist, Professor of trumpet at the Hochschule für Musik Hannover.

"With the Xeno Trumpet, I'm flexible—whether as a soloist or in the orchestra. From classical to jazz, I get the sound that I'm looking for."

©Tsuyoshi Tachibana



David Bilger (US)

Principal trumpet with the Philadelphia Orchestra.

"The second generation of Yamaha NY model trumpets are a perfect fit for me to play with the Philadelphia Orchestra. The trumpets have a sound that is both rich and brilliant, feature a free and open feel, and have improved upon the even sound and solid intonation that has long been a trademark of Yamaha trumpets. With these trumpets, I feel as if I can bring all my musical ideas to life."



Randy Brecker (US)

Grammy-Award Winning Jazz, R&B and Rock Soloist.

"Yamaha Trumpets and Flugelhorns have been keeping me happy for many years. The workmanship is very consistent, the tuning is right on, and the sound projects. Lead trumpet players, jazz players, classical performers—each artist can find a model that will suit his style and technique."



Frank Brodahl (Norway)

Norwegian Wind Ensemble.

"Xeno Trumpets blend very well with brass and orchestra ensembles and carry the sound to the last row of chairs. I love it."



Till Brönner (Germany)

International Jazz Soloist.

"I'm glad to have a trumpet that I really adore. This instrument expresses everything that I would like to say."



Mark David

Professor Royal Academy of Music London.

"Unrivaled Research and Development allied to inspired artistic vision provide me with trumpets of limitless potential."



Louis Dowdeswell

International Jazz Soloist & Leader of the "Louis Dowdeswell Big Band".

"What I find best on my Yamaha Trumpet is that they really gives me the opportunity to play exactly what I have in my head without any barriers and express what I want to do on the instrument whenever I want to do it. That's all you can ask from an instrument."



John Hagstrom (US)

Member of the Chicago Symphony and an Outstanding Soloist.

"The new Xeno C trumpet is the only available orchestral trumpet that allows a player to achieve any sound they can imagine while still having the potential to be compatible with every sound in the orchestra. Yamaha is the only company in the world that can make these instruments available to everyone at the highest level of quality."



Wim Van Hasselt

Professor Musikhochschule Freiburg (Germany).

"Yamaha trumpets possess enough power and grace to express the entire range of human emotion, and help me to liberate my sound."



Thomas Hooten (US)

Principal Trumpet of the Los Angeles Philharmonic Orchestra.

"Consistency, refinement, and beauty of sound, these are the reasons I choose Yamaha."



Sachio Hotokezaka (Japan)

Member of the NHK Symphony Orchestra and Member of the Custom Brass Quintet.

"The brilliant sound and soft tonal colors produced by Yamaha trumpets are ideal for all of my performances, from orchestral playing to solos. I will never be separated from this instrument."



Jens Lindemann (US)

Active International Soloist and Former First Trumpet with the Canadian Brass.

"Yamaha Xeno trumpets have always allowed me to play in a variety of styles with the greatest of ease due to their incredibly well-centered feel. The sound is rich with incredible projection and easily fills the largest concert halls in the world due to its focus. I have played them my entire career because I trust them ... simple!"



Brian Lynch (US)

Highly Sought-After Jazz Artist, Particularly in Bebop and Latin Groups.

"I've finally found an instrument that gives me everything I need! The horn never lets me down, no matter how demanding the musical context or how much I want to put into my improvised line. Thank you, Yamaha, for helping me to keep searching and extending my playing."



Manu Mellaerts (Belgium)

Solo Trumpet with the National Opera "La Monnaie" Brussels and Professor at the Royal Conservatorium Brussels.

"The Yamaha Chicago trumpet models have a full, powerful sound and great projection. They are flexible in all kind of musical styles. I'm glad to play these fantastic trumpets."



Eric Miyashiro (Japan)

Lead Player in a Who's Who of Top Bands and Founder of EM Big Band.

"Yamaha trumpets are well designed and manufactured, but the main reason I play them is because they make my job easier. In studios, concert halls, clubs, wherever the gig, my Yamaha lets me concentrate on making music, and I don't have to worry about anything else."



Tiger Okoshi (US)

Jazz Trumpeter and Professor at the Berklee College of Music in Boston.

"When I'm playing my horn on the stage, all I want to do is paint the air with my colorful sound. It's fun thinking about, 'How can I?' and 'How should I?' The choices between long and short strokes, quick or slow, high in the canvas or low, bright color or dark, with fat brush or skinny pen ... the fact is, I make up my mind and play them before I know it. I paint with one note at a time. ... Only some instruments can let musicians be in a true world of art."



Miroslav Petkov

Principal Trumpet Royal Concertgebouw Orchestra Amsterdam & Professor at Conservatory Amsterdam.

"I love my Yamaha trumpets! Solid in the orchestra, joyful and easy in front of the orchestra."



Marco Pierobon (Italy)

International Soloist and Member of the Gomalan Brass Quintet.

"With all my Yamaha instruments I'm really able to choose the sound colour I need depending on the musical situation and style. It is so easy to go from the most symphonic to the extreme lead sound on the same horn. They are simply perfect amplifiers of the sound that I have in my head!"



Thomas Rolfs (US)

Principal Trumpet, Boston Symphony Orchestra.

"I love playing my new Yamaha C trumpet. It plays with the characteristic ease that Yamaha is famous for and the sound is perfect for our orchestra and our great Symphony Hall in Boston."



Bobby Shew (US)

Jazz Trumpeter Renowned for Powerful Lead Playing and Expressive Solos.

"I have been fortunate to be allowed to work alongside Yamaha designers in order to create the Z Series of trumpets and flugelhorns. They suit me beautifully for both lead and jazz playing. Thank you, Yamaha!!!"



Giuliano Sommerhalder (Netherlands)

International Soloist, Principal Trumpet Orchestre de la Suisse Romande & Professor Musikhochschule Bern (Switzerland).

"Brass players still strive to reach the same musical level as great string players, singers or pianists. But often it's the instrument that prevents them from achieving it. With my Yamaha Trumpets, I fell like I no longer have to worry about this limitation."



Robert Sullivan (US)

Principal Trumpet with Cincinnati Symphony Orchestra.

"I have been playing Yamaha trumpets for more than 10 years because they are the best trumpets I have played, and they get better all the time. The response, intonation, flexibility and warmth of sound are exactly what I want from a trumpet, whether I am performing in the orchestra, chamber ensemble or recording studio."



James Thompson (US)

Soloist and Trumpet Professor at the Eastman School of Music; Former Principal Trumpet of the Atlanta and Montreal Symphony Orchestras.

"I play Yamaha because the instruments give me what I want in terms of sound, response and intonation. They are the highest quality in terms of manufacturing and consistency."



Omar Tomasoni

Principal Trumpet Royal Concertgebouw Orchestra Amsterdam & Professor at Conservatory Amsterdam.

"The ease of playing and flexibility of Yamaha instruments gives me the freedom to make the music I want."



Andrea Tofanelli (Italy)

International Jazz Soloist.

"Regarding the Xeno Europe Trumpet, you cannot think to play without it. It is the ideal horn for players who want to make a difference."

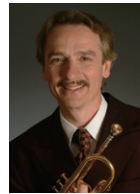

Allen Vizzutti (US)

Soloist in a Multitude of Musical Genres—From Jazz to Classical.

"I have used the complete line of Yamaha trumpets for 20 years. I play them for one reason and one reason only: because they are fantastic. In my musical life, I face a multitude of challenges in a myriad of musical settings. My Yamaha trumpets always help me meet the demands of the professional music world. Their workmanship, quality, consistency and beauty of sound are world-class."



The Boston Symphony Orchestra Trumpet section (US)

[Michael Martin, Thomas Rolfs (Principal), Thomas Siders (Associate Principal), Benjamin Wright]

"Our Yamaha trumpets have the best ringing sound of any trumpets we've ever played. Their range of color, volume and clarity fit perfectly in Symphony Hall with the Boston Symphony Orchestra."

Experience the Evolution of **SILENT Brass™**

SB7X (PM7X+STX-2)
for Trumpet and Cornet



SB6X (PM6X+STX-2)
for Flugelhorn



Using the STX-2 Personal Studio™ featuring Yamaha's original Brass Resonance Modeling™ in combination with the compact and lightweight Pickup Mute™ delivers brass tone so real you'll forget your playing with a mute. What those hear around you, is only a whisper.



Get to Know the Basic Trumpet Parts

1 Mouthpiece

Here's where the sound starts! The mouthpiece transfers vibrations from your lips into the horn. Mouthpieces are made with a variety of options including rim width and shape, cup volume, bore sizes and material. Your choices have a significant influence on the sound and ease in blowing. Selecting a mouthpiece is a very complicated subject, so we suggest you choose a standard size if you're just starting out.

2 Mouthpiece Receiver 3 Leadpipe

The mouthpiece connects to the trumpet at the receiver. The shape of the leadpipe can vary, changing airflow.

4 Piston Valves 5 Finger Hook

Most trumpets have three piston valves that produce notes when pressed in various combinations with the fingers on your right hand. The pinky finger hook helps you hold the instrument and free your left hand. Apply valve oil before and after playing to avoid wear, deterioration and rust.

6 First Tuning Slide 8 Second Tuning Slide 10 Third Tuning Slide

These pipes that can be pulled or pushed to finely adjust the pitch.

7 First Tuning Slide Finger Hook 9 Third Tuning Slide Finger Ring

These finger hooks allow you to hold and steady the instrument while you are playing and while adjusting the pitch with the tuning slides. The basic technique is to hook your thumb on the first tuning slide finger hook and the third finger on the third tuning slide finger ring. Some hooks have a closed ring shape and some have an open "U" shape.

11 Brace

Some models have no brace at all while others have one or two. More braces result in a more solid and unified sound.

12 Main Tuning Slide 13 Water Key

This primary tuning slide provides the most adjustment in pitch. The water key releases condensation that builds up inside the horn while you play.

14 Bell

The music exits the trumpet through the bell. The actual sound—it's timbre and other characteristics—depends on the size, shape and material of the bell as well as the shape of the trim.

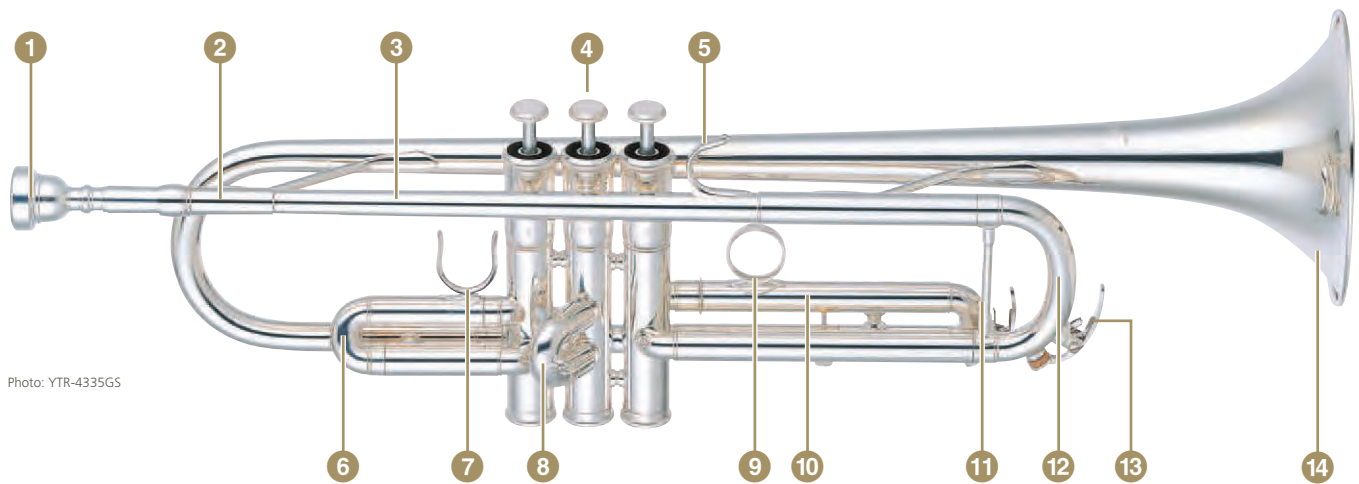

Photo: YTR-4335GS

Other Tips for Choosing a Trumpet

Material and Finish

Brass instruments produce different sounds and tone colors depending on the material and surface finish. Decide what kind of sound you like best, then find an instrument whose material and finish would best produce that sound. Generally, silver plating is most common; however, many jazz musicians prefer a lacquer finish.

• Bell Material

Yellow brass: Bright and energetic sound

Gold brass: Rich and wide sound

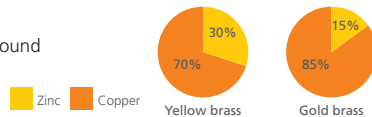

• Finish

Lacquer Finish: Solid and relatively dark sound, particularly good for playing in forte.

Silver Plated Finish: Soft and relatively light sound, capable of expressing a wide variety of subtle nuances.

Brace

The brace affects the appearance as well as the sound and the feeling of playing.

Without Brace: Open feeling

With Brace: Solid sound

Scale Range (B \flat)

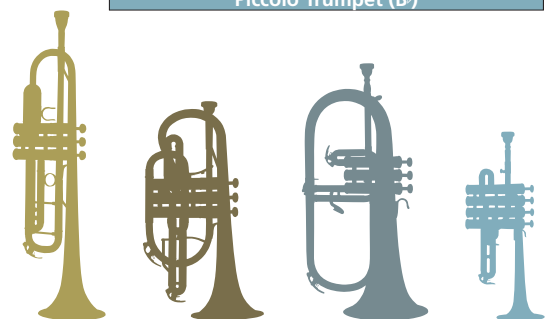
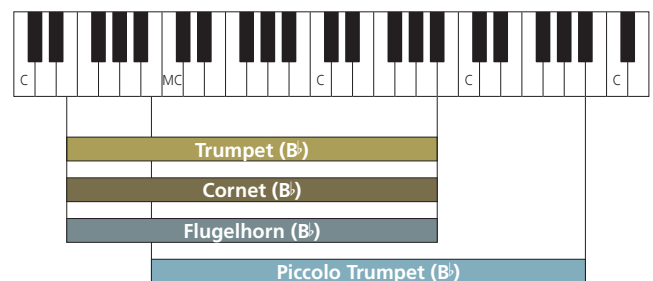

Specifications

Trumpets

Key	Grade	Model	Bell	Bell diameter	Bore size	Finish	Bell type	Mouthpiece	Page	
B ^b	Xeno Artist	YTR-9335CHS*	One piece yellow brass	123 mm (4-7/8")	ML 11.65 mm (0.459")	Silver plate	YL3	TR17B4	04	
		YTR-9335NYS*	One piece yellow brass	123 mm (4-7/8")	ML 11.65 mm (0.459")	Silver plate	YL3	TR17B4	05	
	Custom Xeno	YTR-8335	One piece yellow brass	123 mm (4-7/8")	ML 11.65 mm (0.459")	Clear lacquer	YL3	TR16C4	06	
		YTR-8335S	One piece yellow brass	123 mm (4-7/8")	ML 11.65 mm (0.459")	Silver plate	YL3	TR16C4	06	
		YTR-8335G	One piece gold brass	123 mm (4-7/8")	ML 11.65 mm (0.459")	Clear lacquer	YL3	TR16C4	06	
		YTR-8335GS	One piece gold brass	123 mm (4-7/8")	ML 11.65 mm (0.459")	Silver plate	YL3	TR16C4	06	
		YTR-8345	One piece yellow brass	123 mm (4-7/8")	L 11.73 mm (0.462")	Clear lacquer	YR	TR16C4	06	
		YTR-8345S	One piece yellow brass	123 mm (4-7/8")	L 11.73 mm (0.462")	Silver plate	YR	TR16C4	06	
		YTR-8345G	One piece gold brass	123 mm (4-7/8")	L 11.73 mm (0.462")	Clear lacquer	YR	TR16C4	06	
		YTR-8345GS	One piece gold brass	123 mm (4-7/8")	L 11.73 mm (0.462")	Silver plate	YR	TR16C4	06	
		YTR-8335R	One piece yellow brass	123 mm (4-7/8")	ML 11.65 mm (0.459")	Clear lacquer	YL3	TR16C4	07	
		YTR-8335RS	One piece yellow brass	123 mm (4-7/8")	ML 11.65 mm (0.459")	Silver plate	YL3	TR16C4	07	
		YTR-8335RG	One piece gold brass	123 mm (4-7/8")	ML 11.65 mm (0.459")	Clear lacquer	YL3	TR16C4	07	
		YTR-8335RGS	One piece gold brass	123 mm (4-7/8")	ML 11.65 mm (0.459")	Silver plate	YL3	TR16C4	07	
		YTR-8345R	One piece yellow brass	123 mm (4-7/8")	L 11.73 mm (0.462")	Clear lacquer	YR	TR16C4	07	
		YTR-8345RS	One piece yellow brass	123 mm (4-7/8")	L 11.73 mm (0.462")	Silver plate	YR	TR16C4	07	
		YTR-8345RG	One piece gold brass	123 mm (4-7/8")	L 11.73 mm (0.462")	Clear lacquer	YR	TR16C4	07	
	YTR-8345RGS	One piece gold brass	123 mm (4-7/8")	L 11.73 mm (0.462")	Silver plate	YR	TR16C4	07		
	Custom	YTR-8335LA	One piece yellow brass	127 mm (5")	ML 11.65 mm (0.459")	Gold lacquer	A	TR14B4	08	
		YTR-8335LAS	One piece yellow brass	127 mm (5")	ML 11.65 mm (0.459")	Silver plate	A	TR14B4	08	
		YTR-8330EM	One piece yellow brass	134.4 mm (5-1/4")	Step bore 11.65 mm (0.459")	Gold lacquer	A	EM1-MK2	08	
		YTR-8310Z	One piece yellow brass	127 mm (5")	Step bore 11.3 mm (0.445")	Gold lacquer	A	SHEW-JAZZ	09	
		YTR-8310ZS	One piece yellow brass	127 mm (5")	Step bore 11.3 mm (0.445")	Silver plate	A	SHEW-JAZZ	09	
		YTR-938FFMS*	One piece yellow brass	138mm (5-7/16")	M 11.24 mm (0.442")	Silver plate	—	TR16E4	18	
		YTR-938FFMGs*	One piece gold brass	138mm (5-7/16")	M 11.24 mm (0.442")	Silver plate	—	TR16E4	18	
		Professional	YTR-6335	One piece yellow brass	123 mm (4-7/8")	ML 11.65 mm (0.459")	Gold lacquer	YL2	TR14B4	10
			YTR-6335S	One piece yellow brass	123 mm (4-7/8")	ML 11.65 mm (0.459")	Silver plate	YL2	TR14B4	10
YTR-6345G			One piece gold brass	123 mm (4-7/8")	L 11.73 mm (0.462")	Gold lacquer	YL2	TR14B4	10	
YTR-6345GS	One piece gold brass		123 mm (4-7/8")	L 11.73 mm (0.462")	Silver plate	YL2	TR14B4	10		
YTR-6335RC	Two piece gold brass		123 mm (4-7/8")	ML 11.65 mm (0.459")	Gold lacquer	YL2	TR14B4	10		
YTR-6335F	Two piece yellow brass		123 mm (4-7/8")	ML 11.65 mm (0.459")	Gold lacquer	YL2	TR14B4	17		
Intermediate	YTR-4335GII	Two piece gold brass	123 mm (4-7/8")	ML 11.65 mm (0.459")	Gold lacquer	YL2	TR11B4	11		
	YTR-4335GSII	Two piece gold brass	123 mm (4-7/8")	ML 11.65 mm (0.459")	Silver plate	YL2	TR11B4	11		
Student	YTR-3335	Two piece yellow brass	123 mm (4-7/8")	ML 11.65 mm (0.459")	Gold lacquer	YL2	TR11B4	12		
	YTR-3335S	Two piece yellow brass	123 mm (4-7/8")	ML 11.65 mm (0.459")	Silver plate	YL2	TR11B4	12		
	YTR-2330	Two piece yellow brass	123 mm (4-7/8")	ML 11.65 mm (0.459")	Gold lacquer	YL2	TR11B4	13		
	YTR-2330S	Two piece yellow brass	123 mm (4-7/8")	ML 11.65 mm (0.459")	Silver plate	YL2	TR11B4	13		
	C	Xeno Artist	YTR-9445CHS*	One piece yellow brass	123 mm (4-7/8")	L 11.73 mm (0.462")	Silver plate	YS4	TR17B4	04
YTR-9445NYS*			One piece yellow brass	123 mm (4-7/8")	L 11.73 mm (0.462")	Silver plate	YS4	TR17B4	05	
YTR-9445NYS-YM*			One piece yellow brass	123 mm (4-7/8")	L 11.73 mm (0.462")	Silver plate	YM	TR17B4	05	
Custom Xeno		YTR-8445	One piece yellow brass	123 mm (4-7/8")	L 11.73 mm (0.462")	Clear lacquer	YS4s	TR16C4	07	
		YTR-8445S	One piece yellow brass	123 mm (4-7/8")	L 11.73 mm (0.462")	Silver plate	YS4s	TR16C4	07	
		YTR-8445G	One piece gold brass	123 mm (4-7/8")	L 11.73 mm (0.462")	Clear lacquer	YS4s	TR16C4	07	
		YTR-8445GS	One piece gold brass	123 mm (4-7/8")	L 11.73 mm (0.462")	Silver plate	YS4s	TR16C4	07	
Custom		YTR-948FFMS*	One piece yellow brass	130 mm (5-7/16")	M 11.24 mm (0.442")	Silver plate	—	TR16E4	18	
		YTR-948FFMGs*	One piece gold brass	130 mm (5-7/16")	M 11.24 mm (0.442")	Silver plate	—	TR16E4	18	
C-B ^b		Intermediate	YTR-4435II	Two piece yellow brass	123 mm (4-7/8")	ML 11.65 mm (0.459")	Gold lacquer	YL2	TR11B4	11
	YTR-4435SII		Two piece yellow brass	123 mm (4-7/8")	ML 11.65 mm (0.459")	Silver plate	YL2	TR11B4	11	
E-E ^b	Custom	YTR-9635*	One piece yellow brass	123 mm (4-7/8")	ML 11.65 mm (0.459")	Silver plate	—	TR14B4	16	
E ^b -D	Custom	YTR-9636*	One piece yellow brass	123 mm (4-7/8")	ML 11.65 mm (0.459")	Silver plate	YM	TR14B4	16	
		YTR-9610*	One piece yellow brass	120 mm (4-3/4")	M 11.3 mm (0.445")	Silver plate	—	TR14B4	16	
	Professional	YTR-6610S	One piece yellow brass	120 mm (4-3/4")	M 11.3 mm (0.445")	Silver plate	—	TR14B4	17	
G-F	Custom	YTR-9710*	One piece yellow brass	101 mm (4")/110 mm (4-1/3")	M 11.3 mm (0.445")	Silver plate	—	TR14A4a	17	

[Bell type]

YL2/YL3: Narrow overall, with a comparatively rapid flare
 YR: Narrow with a smooth flare
 A: Larger bell body and bell diameter than the YL2/YL3, with a narrow flare
 YS4/YS4s: Large with a flat flare
 YM: Large, but with a more gentle flare than the YS4 and YS4s

* Order model.

• All specifications are subject to change without notice.

Specifications

Piccolo Trumpets

Key	Grade	Model	Bell	Bell diameter	Bore size	Finish	Bell type	Mouthpiece	Page
B ^b -A	Custom	YTR-988*	One piece yellow brass	97.9mm (3-15/16")	S 10.38 mm (0.409")	Silver plate	—	TR11A5	15
		YTR-9825*	One piece yellow brass	101 mm (4")	M 11.30 mm (0.445")	Silver plate	—	TR11A5, CR11A4	15
		YTR-9835*	One piece yellow brass	101 mm (4")	M 11.30 mm (0.445")	Silver plate	—	TR11A5, CR11A4	15
	Professional	YTR-6810	One piece yellow brass	94 mm (3-3/4")	S 10.50 mm (0.413")	Gold lacquer	—	TR14A4a	15
		YTR-6810S	One piece yellow brass	94 mm (3-3/4")	S 10.50 mm (0.413")	Silver plate	—	TR14A4a	15

Cornets

Key	Grade	Model	Bell	Bell diameter	Bore size	Finish	Bell type	Mouthpiece	Page
B ^b	Custom Neo	YCR-8335	One piece yellow brass	125.5 mm (5")	L 11.9 mm (0.469")	Clear lacquer	CR5	CR16E (S)	20
		YCR-8335S	One piece yellow brass	125.5 mm (5")	L 11.9 mm (0.469")	Silver plate	CR5	CR16E (S)	20
		YCR-8335G	One piece gold brass	125.5 mm (5")	L 11.9 mm (0.469")	Clear lacquer	CR5	CR16E (S)	20
		YCR-8335GS	One piece gold brass	125.5 mm (5")	L 11.9 mm (0.469")	Silver plate	CR5	CR16E (S)	20
	Professional	YCR-6330II	One piece yellow brass	119 mm (4-2/3")	L 11.73 mm (0.462")	Gold lacquer	CR3	CR14E (S)	20
		YCR-6330SII	One piece yellow brass	119 mm (4-2/3")	L 11.73 mm (0.462")	Silver plate	CR3	CR14E (S)	20
	Intermediate	YCR-4330GII	Two piece gold brass	119 mm (4-2/3")	ML 11.65 mm (0.459")	Gold lacquer	CR3	CR11E4 (S)	21
		YCR-4330GSII	Two piece gold brass	119 mm (4-2/3")	ML 11.65 mm (0.459")	Silver plate	CR3	CR11E4 (S)	21
	Student	YCR-2330III	Two piece yellow brass	119 mm (4-2/3")	ML 11.65 mm (0.459")	Gold lacquer	CR3	CR11E4 (S)	21
		YCR-2330SIII	Two piece yellow brass	119 mm (4-2/3")	ML 11.65 mm (0.459")	Silver plate	CR3	CR11E4 (S)	21
		YCR-2310III	Two piece yellow brass	119 mm (4-2/3")	ML 11.65 mm (0.459")	Gold lacquer	CR3	CR11C4 (L)	21
		YCR-2310SIII	Two piece yellow brass	119 mm (4-2/3")	ML 11.65 mm (0.459")	Silver plate	CR3	CR11C4 (L)	21
C	Custom	YCR-9435*	One piece yellow brass	123 mm (4-7/8")	ML 11.65 mm (0.459")	Silver plate	YM	TR16C4	20
E ^b	Custom Neo	YCR-8620S	One piece yellow brass	120 mm (4-3/4")	ML 11.3 mm (0.445")	Silver plate	D	CR6B4 (L)	20
		YCR-8620	One piece yellow brass	120 mm (4-3/4")	ML 11.3 mm (0.445")	Clear lacquer	D	CR6B4 (L)	20
	Student	YCR-2610SIII	Two piece yellow brass	119 mm (4-2/3")	ML 11.65 mm (0.459")	Silver plate	CR4	CR7D4d (S)	21

[Bell type]

CR5: Larger flare and bell diameter than the CR3

CR3: Approximately the same body size as the CR5, with a narrower flare

YM: Large, but with a more gentle flare than the YS4 and YS4s

D: For D and E^b trumpets

CR4: For E^b cornets

Flugelhorns

Key	Grade	Model	Bell	Bell diameter	Bore size	Finish	Bell type	Mouthpiece	Page
B ^b	Custom	YFH-8310Z	One piece yellow brass	151.8 mm (6")	S 10.5 mm (0.413")	Clear lacquer	FH1	SHEW-FH	19
		YFH-8310ZS	One piece yellow brass	151.8 mm (6")	S 10.5 mm (0.413")	Silver plate	FH1	SHEW-FH	19
		YFH-8310ZG	One piece yellow brass	151.8 mm (6")	S 10.5 mm (0.413")	Clear lacquer	FH1	SHEW-FH	19
		YFH-8310ZGS	One piece yellow brass	151.8 mm (6")	S 10.5 mm (0.413")	Silver plate	FH1	SHEW-FH	19
	Professional	YFH-8315G	Two piece gold brass	151.8 mm (6")	S 10.5 mm (0.413")	Clear lacquer	FH1	FH14F4	19
		YFH-8315GS	Two piece gold brass	151.8 mm (6")	S 10.5 mm (0.413")	Silver plate	FH1	FH14F4	19
		YFH-631G	Two piece gold brass	151.8 mm (6")	M 11 mm (0.433")	Clear lacquer	FH1	FH11F4	19
		YFH-631GS	Two piece gold brass	151.8 mm (6")	M 11 mm (0.433")	Silver plate	FH1	FH11F4	19

* Order model.

• All specifications are subject to change without notice.