



PORTABLE PA SYSTEM / SYSTÈME DE SONORISATION PORTATIF  
SISTEMA DE PA PORTÁTIL / ПОРТАТИВНАЯ СИСТЕМА ЗВУКОУСИЛЕНИЯ  
便携式PA音箱 / 可攜式PA系統 / 포터블 PA 시스템 / ポータブルPAシステム

# STAGEPAS 100 BTR

## STAGEPAS 100

- EN** Owner's Manual
- DE** Benutzerhandbuch
- FR** Mode d'emploi
- ES** Manual de instrucciones
- PT** Manual do Proprietário
- IT** Manuale di istruzioni
- RU** Руководство пользователя
- ZH-CN** 使用说明书
- ZH-TW** 使用說明書
- KO** 사용설명서
- JA** 取扱説明書

English

Deutsch

Français

Español

Português

Italiano

Русский

简体中文

繁體中文

한국어

日本語

**COMPLIANCE INFORMATION STATEMENT  
(Supplier's declaration of conformity procedure)**

Responsible Party: Yamaha Corporation of America  
Address: 6600 Orangethorpe Avenue, Buena Park, CA. 90620, U.S.A.  
Telephone: 714-522-9011  
Type of Equipment: PORTABLE PA SYSTEM  
Model Name: STAGEPAS 100BTR, STAGEPAS 100

This device complies with Part 15 of the FCC Rules.

Operation is subject to two following conditions:

- 1) this device may not cause harmful interference, and
- 2) this device must accept any interference received including interference that may cause undesired operation.

(529-M02 FCC sdoc YCA 02)

**FCC INFORMATION (U.S.A.)**

**1. IMPORTANT NOTICE: DO NOT MODIFY THIS UNIT!**

This product, when installed as indicated in the instructions contained in this manual, meets FCC requirements. Modifications not expressly approved by Yamaha may void your authority, granted by the FCC, to use the product.

**2. IMPORTANT:** When connecting this product to accessories and/or another product use only high quality shielded cables.

Cable/s supplied with this product **MUST** be used. Follow all installation instructions. Failure to follow instructions could void your FCC authorization to use this product in the USA.

**3. NOTE:** This product has been tested and found to comply with the requirements listed in FCC Regulations, Part 15 for Class "B" digital devices. Compliance with these requirements provides a reasonable level of assurance that your use of this product in a residential environment will not result in harmful interference with other electronic devices. This equipment generates/uses radio frequencies and, if not installed and used according to the instructions found in the users manual, may cause interference harmful to the operation of other electronic devices. Compliance with FCC regulations does not guarantee that interference will not occur in all installations. If this product is found to be the source of interference, which can be determined by turning the unit "OFF" and "ON", please try to eliminate the problem by using one of the following measures:

- Relocate either this product or the device that is being affected by the interference.
- Utilize power outlets that are on different branch (circuit breaker or fuse) circuits or install AC line filter/s.
- In the case of radio or TV interference, relocate/reorient the antenna. If the antenna lead-in is 300 ohm ribbon lead, change the lead-in to co-axial type cable.

If these corrective measures do not produce satisfactory results, please contact the local retailer authorized to distribute this type of product. If you cannot locate the appropriate retailer, please contact Yamaha Corporation of America, 6600 Orangethorpe Avenue, Buena Park, CA 90620, U.S.A.

The above statements apply **ONLY** to those products distributed by Yamaha Corporation of America or its subsidiaries.

(529-M04 FCC class B YCA 02)

The model number, serial number, power requirements, etc., may be found on or near the name plate, which is at the bottom of the unit. You should note this serial number in the space provided below and retain this manual as a permanent record of your purchase to aid identification in the event of theft.

**Model No.**

---

**Serial No.**

---

(1003-M06 plate bottom en 01)

# Introduction

Thank you for purchasing the Yamaha STAGEPAS 100BTR or STAGEPAS 100 portable PA System! (In this manual, these two models are collectively referred to as “STAGEPAS 100”). This product consists of a single speaker unit and is designed for amplification of music or speech at live performances or other events. This Owner’s Manual is designed for individual users or other personnel who use this product as company or school equipment. The manual explains how to set up and operate the product. To get the most out of this product and enjoy its wide range of sophisticated features, we recommend that you read this manual thoroughly and keep it in a safe place for future reference.

## Features

- Built-in, simplified three-channel mixer (two mic/line inputs and a stereo input)
- The compact-body speaker offers high-quality sound and ample power and projection for various PA situations, including business meetings and conferences applications.
- The built-in speaker enables listening to music from your smartphone via Bluetooth®.
- This product can be attached to a commercially available microphone stand.
- The built-in battery enables you to use the product without connecting the power adaptor. (STAGEPAS 100BTR only)

## Included Accessories

- Power cord x1
- Power adaptor x1
- Owner’s Manual (this book) x1

## Optional items

Speaker carrying bag (BAG-STP100)

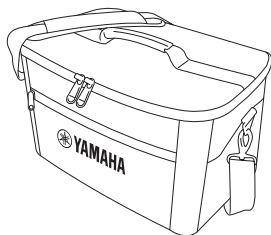

# Table of Contents

<b>Introduction</b> .....	<b>3</b>
Features .....	3
Included Accessories .....	3
Optional items.....	3
<b>PRECAUTIONS</b> .....	<b>4</b>
<b>NOTICE</b> .....	<b>6</b>
<b>Information</b> .....	<b>6</b>
<b>Controls and Functions</b> .....	<b>8</b>
Front panel .....	8
Rear panel .....	9
<b>Quick Start Guide</b> .....	<b>10</b>
Connection example .....	10
Connecting the unit to power.....	10
Getting sound out of the speaker .....	11
<b>Installation and Usage Examples</b> .....	<b>12</b>
Installing the unit on the floor .....	12
Installing the unit on a microphone stand .....	12
Using the handle to carry the speaker .....	12
<b>Using the Bluetooth® Function</b> .....	<b>13</b>
Registering (pairing) a Bluetooth® device.....	13
Connecting a Bluetooth® device .....	13
Playing music on a Bluetooth® device.....	13
Disconnecting the Bluetooth® device .....	13
<b>Charging the Build-in Battery</b> <b>(STAGEPAS 100BTR Only)</b> .....	<b>14</b>
Charging the battery .....	14
[BATTERY] LED status.....	14
<b>Troubleshooting</b> .....	<b>15</b>
<b>Specifications</b> .....	<b>17</b>
<b>Dimensions</b> .....	<b>18</b>
<b>Block Diagram</b> .....	<b>End of the manual</b>

# PRECAUTIONS

## PLEASE READ CAREFULLY BEFORE PROCEEDING

Please keep this manual in a safe place for future reference.



### WARNING

**Always follow the basic precautions listed below to avoid the possibility of serious injury or even death from electrical shock, short-circuiting, damages, fire or other hazards. These precautions include, but are not limited to, the following:**

#### If you notice any abnormality

- If any of the following problems occur, immediately turn off the power switch and disconnect the electric plug from the outlet.
    - The power cord or plug becomes frayed or damaged.
    - Unusual smells or smoke are emitted.
    - Some object, or water has been dropped into the product.
    - There is a sudden loss of sound during use of the product.
    - Cracks or other visible damage appear on the product.
- Then have the product inspected or repaired by qualified Yamaha service personnel.

#### Power supply

- Do not place the power cord near heat sources such as heaters or radiators, and do not excessively bend or otherwise damage the cord, place heavy objects on it, or place it in a position where anyone could walk on, trip over, or roll anything over it.
- Only use the voltage specified as correct for the product. The required voltage is printed on the name plate of the product.
- Use the supplied adaptor only. Using the wrong adaptor can result in damage to the product or overheating.
- Use only the supplied power cord/plug. If you intend to use the product in an area other than in the one you purchased, the included power cord may not be compatible. Please check with your Yamaha dealer.
- Do not use the supplied adaptor/cord/plug for other products.
- Check the electric plug periodically and remove any dirt or dust which may have accumulated on it.
- Make sure to fully insert the electric plug to prevent electric shocks or fire.
- When setting up the product, make sure that the AC outlet you are using is easily accessible. If some trouble or malfunction occurs, immediately turn off the power switch and disconnect the plug from the outlet. Even when the power switch is turned off, as long as the power cord is not unplugged from the wall AC outlet, the product will not be disconnected from the power source.

- Remove the electric plug from the outlet when the product is not to be used for extended periods of time.
- Do not touch the product or the electric plug during an electrical storm.

#### Do not open

- This product contains no user-serviceable parts. Do not attempt to disassemble the internal parts or modify them in any way.

#### Water warning

- Do not expose the product to rain, use it near water or in damp or wet conditions, or place on it any containers containing liquids which might spill into any openings.
- Never insert or remove an electric plug with wet hands.

#### Fire warning

- Do not place any burning items or open flames near the product, since they may cause a fire.

#### Hearing loss

- Before connecting the product to other devices, turn off the power for all devices. Also, before turning the power of all devices on or off, make sure that all volume levels are set to the minimum. Failing to do so may result in hearing loss, electric shock, or device damage.
- When turning on the AC power in your audio system, always turn on the product LAST, to avoid hearing loss and speaker damage. When turning the power off, the product should be turned off FIRST for the same reason.

#### Handling caution

- Do not subject this product or the power adaptor to mechanical shock or drop. Doing so may result in fire, electric shock, malfunction.
- Do not intentionally short this product. Doing so may result in fire or injury.
- Do not place this product in the following places. Doing so may result in fire or injury.
  - A place where the temperature becomes extremely high, such as in a place exposed to direct sunshine (e.g., inside a car during the day) or near a fire.
  - A place of extremely low air pressure or low temperature.
  - A place of excessive dirt, dust or humidity.

#### Charging (STAGEPAS 100BTR only)

- For details on how to charge the battery, be sure to read this manual and follow the instructions. Failure to comply may result in fire, overheating, explosion or malfunction.
- Never charge when this product is wet. Doing so may cause electric shock, fire, or malfunction due to short circuiting.
- Charges within the specified charging temperature range. Charging at a temperature outside the range may cause burns, injury, or malfunction.

## Wireless unit

---

- Do not use this product near medical devices or inside medical facilities. Radio waves from this product may affect electro-medical devices.
- Do not use this product within 15 cm (6 in) of persons with a heart pacemaker implant or a defibrillator implant. Radio waves from this product may affect electro-medical devices, such as a heart pacemaker implant or defibrillator implant.



**Always follow the basic precautions listed below to avoid the possibility of physical injury to you or others. These precautions include, but are not limited to, the following:**

### Power supply

---

- Do not cover or wrap the AC adaptor with a cloth or blanket.
- When removing the electric plug from the product or an outlet, always hold the plug itself and not the cord. Pulling by the cord can damage it.

### Location and connection

---

- Do not place the product in an unstable position or a location with excessive vibration, where it might accidentally fall over and cause injury.
- Keep this product out of reach of children. This product is not suitable for use in locations where children are likely to be present.
- To ensure proper heat dissipation of the product, when installing it:
  - Do not cover it with any cloth.
  - Make sure the top surface faces up; do not install on its sides or upside down.
  - Do not use the product in a confined, poorly-ventilated location.

Inadequate ventilation can result in overheating, possibly causing damage to the product(s), or even fire. Make sure that there is adequate space around the product: at least 10 cm above, 10 cm at the sides and 10 cm behind.
- Do not place the product in a location where it may come into contact with corrosive gases or salt air. Doing so may result in malfunction.
- Before moving the product, remove all connected cables.
- Do not use the speaker's handles for suspended installation. Doing so can result in damage or injury.
- Do not hold the bottom of the product when transporting or moving it. In doing so, you may pinch your hands under the product, and result in injury.
- Do not press the rear panel of the product against the wall. Doing so may cause the plug and speaker cable to come in contact with the wall and detach from the power cord, resulting in short circuiting, malfunction, or even fire.

## Maintenance

---

- Remove the power plug from the AC outlet when cleaning the product.

### Handling caution

---

- Do not insert your fingers or hands in any gaps or openings on the product (ports, etc.).
- Do not rest your weight on the product or place heavy objects on it.
- Do not operate the product if the sound is distorting. Prolonged use in this condition could cause overheating and result in fire.
- Turn off the power completely when the product is not to be used for extended periods of time. The leakage current of this product may cause over-discharge.

## NOTICE

To avoid the possibility of malfunction/damage to the product, or damage to other property, follow the notices below.

### ■ Handling and maintenance

- Do not use the product in the vicinity of a TV, radio, or other electric products. Otherwise, the product, TV, or radio may generate noise.
- Do not expose the product to excessive dust or vibration, or extreme cold or heat, in order to prevent the possibility of panel disfiguration, unstable operation, or damage to the internal components.
- Do not install in locations where temperature changes are severe. Otherwise, condensation may form on the inside or the surface of the product, causing it to break.
- If there is reason to believe that condensation might have occurred, leave the product for several hours without turning on the power until the condensation has completely dried out, in order to prevent possible damage.
- When cleaning the product, use a dry and soft cloth. Do not use paint thinners, solvents, cleaning fluids, or chemical-impregnated wiping cloths, since this might cause alteration or discoloration.
- To avoid generating unwanted noise, make sure there is adequate distance between the AC adaptor and the product.

### ■ Handling and maintenance for rechargeable battery (STAGEPAS 100BTR only)

This device contains a lithium-ion battery.

- You should recharge the batteries at least once every six months, to ensure that they stay functional. If the batteries are not used for a long time, they may fail to recharge.
- The battery cannot be recharged at a temperature outside of that which is specified. Recharge the battery within the specified temperature range.
- Rechargeable batteries have limited lifetimes, and their capacity degrades depending on the method of storage, the environment, frequency of use and the passage of time.
- The battery is not removable by the user.
- Lithium-ion batteries can be recycled. After usage, you may recycle the battery, but never attempt to remove it by yourself. Have the device inspected by qualified Yamaha service personnel. If there is no Yamaha service personnel in your area, dispose of it properly according to relevant environmental laws and disposal rules in your area.

## Information

### ■ About functions

- Even when the [⏻] (power) switch is turned off (power lamp is off), electricity is still flowing to the product at some or minimum levels. When you are not using the product for a long time, make sure you unplug the power cord from the wall AC outlet.
- XLR-type connectors are wired as follows (IEC60268 standard): pin 1: ground, pin 2: hot (+), and pin 3: cold (-).

### ■ About this manual

- The illustrations as shown in this manual are for instructional purposes only.
- The company names and product names in this manual are the trademarks or registered trademarks of their respective companies.

### ■ About disposal

This product contains recyclable components. When disposing of this product, please contact the appropriate local authorities.

Yamaha cannot be held responsible for damage caused by improper use or modifications to the product, or data that is lost or destroyed.



The Bluetooth® word mark and logos are registered trademarks owned by Bluetooth SIG, Inc. and any use of such marks by Yamaha Corporation is under license.

This transmitter must not be co-located or operated in conjunction with any other antenna or transmitter.

(554-M01 FCC transmitter 01)

This equipment complies with FCC radiation exposure limits set forth for an uncontrolled environment and meets the FCC radio frequency (RF) Exposure Guidelines. This equipment should be installed and operated keeping the radiator at least 20cm or more away from person's body.

(554-M03 FCC mobile SAR 01)

This equipment complies with ISED radiation exposure limits set forth for an uncontrolled environment and meets RSS-102 of the ISED radio frequency (RF) Exposure rules. This equipment should be installed and operated keeping the radiator at least 20cm or more away from person's body.

(555-M04 ISED mobile SAR 01)

This device contains licence-exempt transmitter(s)/receiver(s) that comply with Innovation, Science and Economic Development Canada's licence-exempt RSS(s). Operation is subject to the following two conditions:

1. This device may not cause interference.
2. This device must accept any interference, including interference that may cause undesired operation of the device.

(555-M13 ISED RSS en 01)

#### Information for users on collection and disposal of old equipment:



This symbol on the products, packaging, and/or accompanying documents means that used electrical and electronic products should not be mixed with general household waste. For proper treatment, recovery and recycling of old products, please take them to applicable collection points, in accordance with your national legislation.

By disposing of these products correctly, you will help to save valuable resources and prevent any potential negative effects on human health and the environment which could otherwise arise from inappropriate waste handling.

For more information about collection and recycling of old products, please contact your local municipality, your waste disposal service or the point of sale where you purchased the items.

#### For business users in the European Union:

If you wish to discard electrical and electronic equipment, please contact your dealer or supplier for further information.

#### Information on Disposal in other Countries outside the European Union:

This symbol is only valid in the European Union. If you wish to discard these items, please contact your local authorities or dealer and ask for the correct method of disposal.

(58-M02 WEEE en 01)

# Controls and Functions

## Front panel

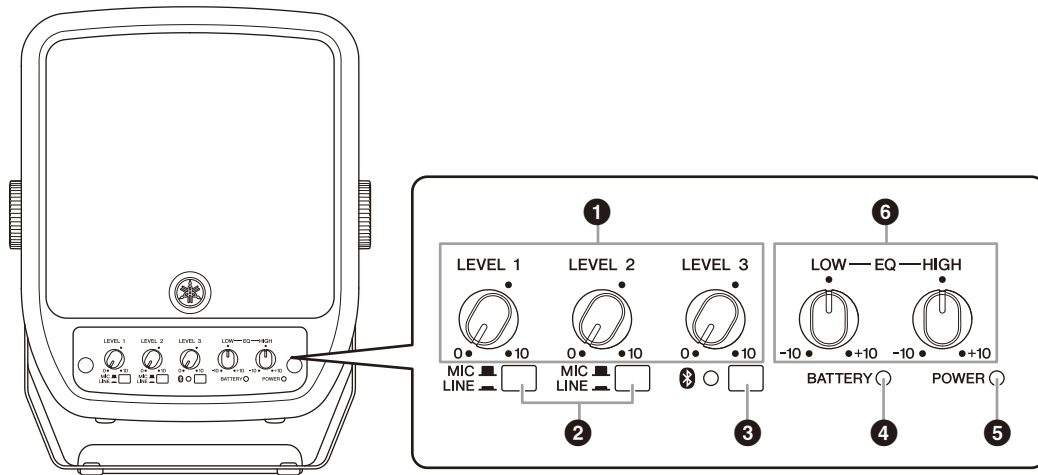

### 1 [LEVEL] controls

Use these controls to adjust the volume for input channels 1–3. To reduce noise, set the [LEVEL] control on unused channels to minimum (zero).

### 2 [MIC/LINE] switches (input channels 1&2)

For low-level signals (including microphones), set the switches to the MIC (🗣️) position. For high-level signals (including electronic musical instruments and audio devices), set the switches to the LINE (🔊) position.

### 3 [🔗] (Bluetooth) switch/LED

This switch turns the Bluetooth function on or off. It is also used to pair (register) a Bluetooth device (page 13). The LED indicates the following status:

LED	Status
Off	Bluetooth off
Lit steadily (blue)	Bluetooth connected
Flashing slowly	Searching for a Bluetooth device
Flashing rapidly	Waiting for Bluetooth pairing

#### NOTE

- The STAGEPAS 100 enables you to pair (register) up to eight Bluetooth devices. Once a ninth Bluetooth device has been paired successfully, the pairing information for the Bluetooth device that was connected earliest will be deleted.
- Only one registered device can establish a connection at a time. Multiple devices cannot be connected at the same time.

### 4 [BATTERY] LED (STAGEPAS 100BTR only)

The LED indicates the amount of remaining battery charge or the charging status. For more information, refer to “Charging the Built-in Battery” (page 14).

### 5 [POWER] LED

Lights up when the [⏻] (Power) switch (14) is turned on.

### 6 [EQ] controls

[LOW]: From the center position, turn these controls clockwise to boost the low range, and turn them counter-clockwise to cut the low range.

[HIGH]: From the center position, turn these controls clockwise to boost the high range, and turn them counter-clockwise to cut the high range.



## Rear panel

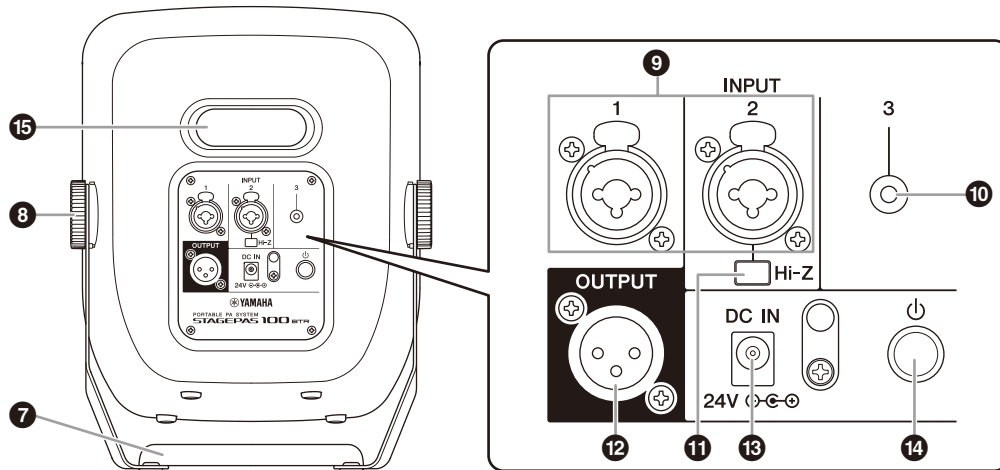

### 7 Handle

Use this handle to set up the speaker on the floor or install it on a microphone stand. You can also use it as a carrying handle to transport the unit. For more information, refer to “Installation and Usage Examples” (page 12).

### 8 Fixing screws

Turn the screws clockwise to tighten them. Turn the screws counter-clockwise to loosen them.

### 9 [INPUT] jacks (channels 1&2)

These are mic/line input jacks. These combo jacks support both XLR and phone plugs. Connect microphones, guitars, electronic musical instruments or audio equipment. Channel 2 supports Hi-Z. Set the [MIC/LINE] switches (2) according to the input signal level.



XLR



Phone

### 10 [INPUT] jack (channel 3)

This input jack supports a stereo-mini plug. Connect line-level devices such as electronic musical instruments, acoustic-electric guitars, CD players, and portable audio players. A stereo input signal will be internally mixed into a monaural signal.

### 11 [Hi-Z] switch (channel 2)

Turn this switch on when connecting a musical instrument with passive pickups (such as an acoustic-electric guitar or electric bass without a battery) directly to the STAGEPAS 100 without a DI (direct box). This function is effective only for the signals input via the phone jack.

### 12 [OUTPUT] jack

This output jack supports an XLR-type plug. You can connect a powered speaker to this jack for monitoring purposes. Mixed monaural signals are output from here.

### 13 [DC IN] jack

Connect the included power adaptor here.

### 14 [⏻] (Power) switch

Press and hold down this switch to turn the power to the unit on or off. The [POWER] LED (5) on the front panel lights up when the power is turned on.

#### NOTICE

- Even when the [⏻] (Power) switch is turned off (the LED turns off), a minimal amount of electric current is still flowing to the unit. If you plan not to use the unit for an extended period of time, be sure to unplug the power cord from the AC outlet.
- Rapidly turning the [⏻] (Power) switch on and off in succession may cause the unit to malfunction. After turning off the [⏻] (Power) switch, wait for about six seconds before turning it on again.

### 15 Bass-reflex port

This is a bass-reflex port of this product. Do not insert your hand or finger into this port.

#### NOTE

Air blowing out of the bass reflex ports is normal, and often occurs when the speaker is handling program material with heavy bass content.

# Quick Start Guide

This section explains how to set up and output sound from the STAGEPAS 100.

## Connection example

Before making connections, lower the volume level to the minimum by rotating the [LEVEL] controls counter-clockwise.

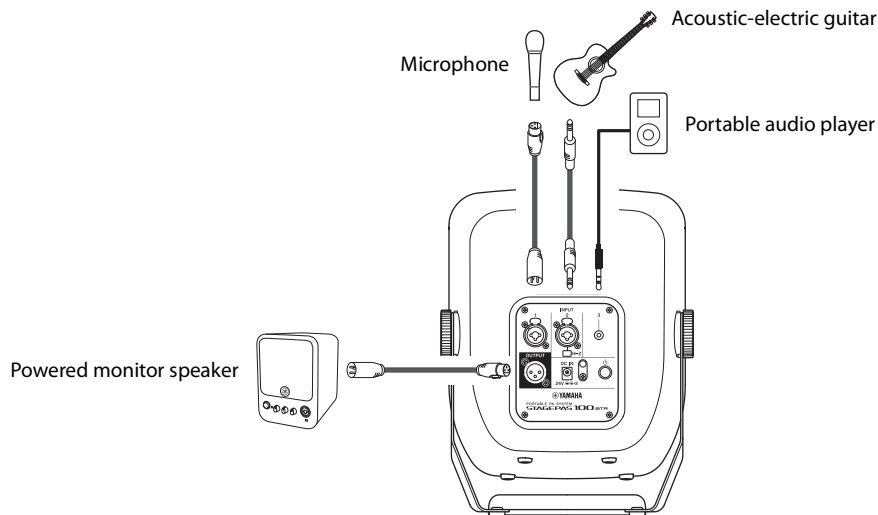

## Connecting the unit to power



### WARNING

- Use only the included power adaptor and power cord. If you use a non-specified power adaptor or power cord, heat may be generated, or malfunction or fire may be caused.
- If you plan not to use the unit for an extended period of time, or if there is a risk of lightning strikes, be sure to unplug the power cord from the AC outlet. Otherwise, an electrical shock, fire or malfunction may be caused.

**1** Connect the power cord to the power adaptor.

**2** Connect the power adaptor to the [DC IN] jack on the rear panel of the STAGEPAS 100.

**3** Insert the plug on the power cord into an AC outlet.

The STAGEPAS 100BTR automatically starts charging the battery.

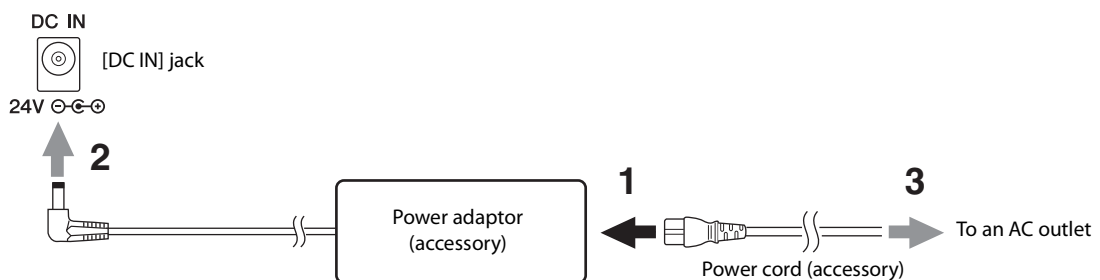

### NOTICE

Even when the [⏻] (Power) switch is turned off, a certain minimal amount of electric current still flows to the unit. If you plan not to use the unit for an extended period of time be sure to unplug the power cord from the AC outlet.

### NOTE

- Locate the power adaptor at a sufficient distance from the STAGEPAS 100.
- When you remove the power adaptor, first turn off the power to the unit, and then follow this order in reverse.

# Getting sound out of the speaker

- 1 Make sure that the power to the STAGEPAS 100 is turned off (the [POWER] LED is turned off).



- 2 Turn the [LEVEL] controls to the minimum (zero).



- 3 Set the [EQ] controls to the center (0) position.

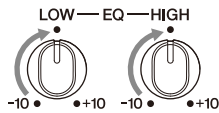

- 4 Set the [MIC/LINE] switch to the MIC (■) position for channels to which a microphone is connected. Set the [MIC/LINE] switch to the LINE (▬) position for channels to which a musical instrument or audio device is connected.

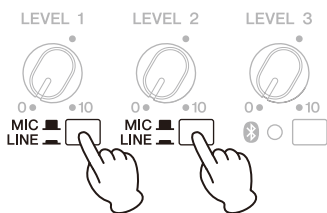

- 5 Turn on the power to the connected musical instrument or audio device, then press and hold down the [⏻] (Power) switch on the STAGEPAS 100 to turn on the power to the unit.

The [POWER] LED lights up.

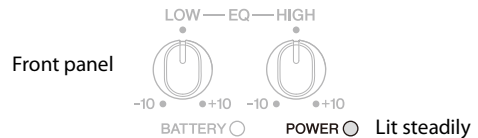
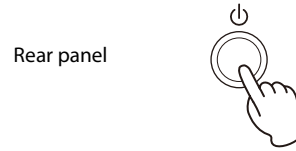

- 6 While playing your musical instrument or singing into the microphone, use the [LEVEL] controls to adjust the volume of the corresponding channels.



If you can hear sound and the volume seems appropriate, setup is complete. If not, please refer to the checklist in the "Troubleshooting" section (page 15).

### NOTE

When you turn off the power to all devices, first turn off the power to the STAGEPAS 100, and then turn off the connected sound sources (such as a musical instrument or audio device) to avoid any loud, unexpected noises from the speaker.

## Adjusting the volume

### • When the volume is too loud

First, turn the [LEVEL] controls to the minimum (zero). Set the [MIC/LINE] switch to the LINE (▬) position, then slowly raise the [LEVEL] controls until the desired volume is reached.

### • When the volume is too low

First, turn the [LEVEL] controls to the minimum (zero). Set the [MIC/LINE] switch to the MIC (■) position, then slowly raise the [LEVEL] controls until the desired volume is reached.

# Installation and Usage Examples

## Installing the unit on the floor

This is an example of the standard installation. The handle functions as a speaker stand, with the rubber feet on the handle in contact with the floor.

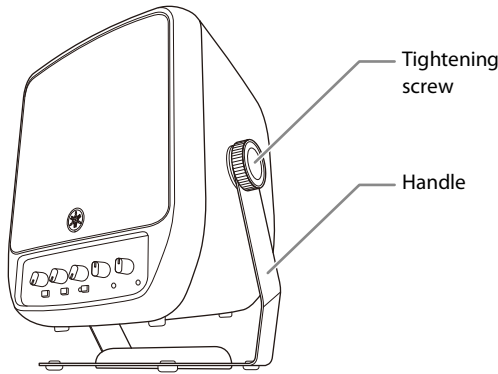

## Using the handle to carry the speaker

You can also use the handle to carry the speaker by hand.

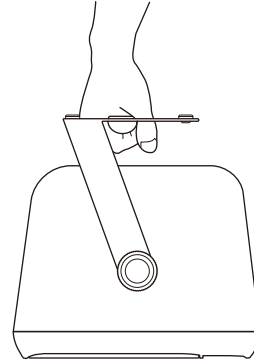

## Installing the unit on a microphone stand

You can install this product on a commercially available microphone stand, and adjust the height for using it as a monitor speaker or simple PA system.

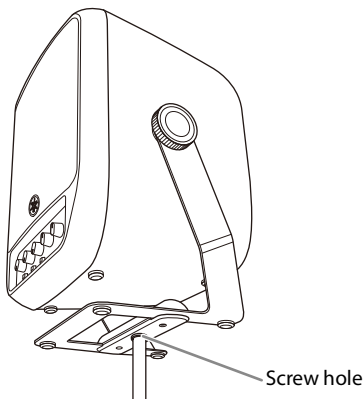

Use the screw hole (3/8 inch diameter) located on the bottom of the handle and a screw of 9–11 mm length to install the speaker on your microphone stand.

When you install this product on a microphone stand, observe the following precautions to avoid damaging the devices or injuring yourself:



### CAUTION

- Extend the tripod legs of the microphone stand as wide as possible to maximize stability.
- The height of this product installed on the microphone stand should be 115 cm or lower.
- Do not set up the product on any unstable, uneven, or tilted surface. Be sure to place the product on a stable and horizontal surface.
- Make sure that there is adequate space around the connected cables.
- After installing the product on a microphone stand, be sure to tighten the fixing screws securely so that the speaker will not rotate.



### CAUTION

- When you adjust the angle of the handle, pay attention not to pinch your fingers. Otherwise, you might be injured.
- If you carry the speaker by holding the handle, be sure to tighten the fixing screws securely so that the handle will not move. If the handle is not securely fixed, the speaker may rotate, possibly pinching your fingers between the handle and the speaker, leading to injury.

## Adjusting the speaker angle

- 1 Loosen both fixing screws.
- 2 Adjust the speaker angle.
- 3 Tighten the fixing screws to affix the unit.

### NOTICE

If you loosen the fixing screws too much, the speaker may separate from the handle and fall, possibly causing it to break.

### NOTE

- You can also adjust the speaker angle by moving it by hand.
- If the fixing screws come off, refer to the illustration below to attach them again.

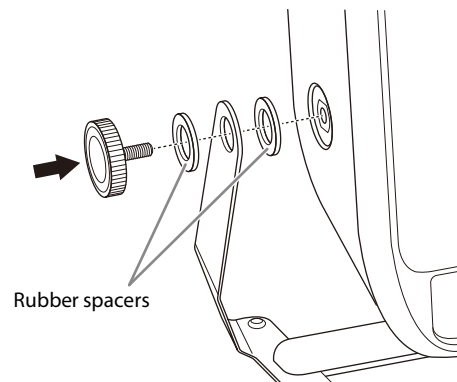

# Using the Bluetooth® Function

You can set up the STAGEPAS100 so it will play music from Bluetooth devices, such as a mobile device.

## Registering (pairing) a Bluetooth® device

Before you connect a Bluetooth device for the first time, you need to “pair” the device. “Pairing” is a process of registering one Bluetooth device (this product) from another Bluetooth device (such as your smartphone).

Once pairing is complete, you will be able to reconnect those devices easily after you terminate a Bluetooth connection.

- 1 **Make sure that the [Bluetooth] (Bluetooth) LED is turned off. If the LED is lit steadily or flashing, press the [Bluetooth] (Bluetooth) switch to disable the Bluetooth function.**

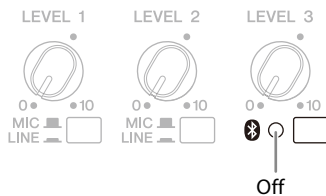

- 2 **Press and hold down the [Bluetooth] (Bluetooth) switch for three seconds or longer.**

The [Bluetooth] (Bluetooth) LED will flash rapidly, indicating that the unit is ready for pairing.



Flashing rapidly

- 3 **Turn on the Bluetooth function on the Bluetooth device that you want to connect.**

For more information, refer to the owner’s manual for the Bluetooth device.

- 4 **Once the Bluetooth device displays a list of other Bluetooth devices that are available for connection, select STAGEPAS100.**

When the pairing process is complete, the Bluetooth connection is established and the [Bluetooth] (Bluetooth) LED lights up.



Lit steadily

### NOTE

- The STAGEPAS 100 enables you to pair (register) up to eight Bluetooth devices. Once a ninth Bluetooth device has been paired successfully, the pairing information for the Bluetooth device that was connected earliest will be deleted.
- You must complete the pairing process on the Bluetooth device within two minutes.

## Connecting a Bluetooth® device

- 1 **Press and hold down the [Bluetooth] (Bluetooth) switch for one second.**

The [Bluetooth] (Bluetooth) LED will flash slowly, indicating that the unit is searching for a device.



Flashing slowly

- 2 **Turn on the Bluetooth function on the Bluetooth device that you want to connect.**

Once a connection is made, the [Bluetooth] (Bluetooth) LED lights up.

If the connection is not successful, select STAGEPAS100 from the list of Bluetooth devices available for connection.

## Playing music on a Bluetooth® device

You can play music and adjust the output volume level from your Bluetooth device.

### NOTE

- You cannot adjust the volume level using the STAGEPAS 100.
- If you receive a call or text message while playing music on a Bluetooth device such as a smartphone, music playback might be paused momentarily. To avoid this interruption, enable Airplane Mode, and then set Bluetooth to ON on your Bluetooth device.

## Disconnecting the Bluetooth® device

To disconnect the Bluetooth device, do one of the following:

- Use the Bluetooth device to disconnect. (The [Bluetooth] (Bluetooth) LED on the speaker turns off.)
- Press the [Bluetooth] (Bluetooth) switch on the speaker to turn off the Bluetooth function (the [Bluetooth] (Bluetooth) LED will turn off.)

### NOTICE

**Before you turn off the power to the unit, make sure that the Bluetooth function is turned off (the [Bluetooth] (Bluetooth) LED is turned off). If you turn off the power to the unit while the Bluetooth function remains enabled, the unit might lose the pairing information.**

# Charging the Build-in Battery (STAGEPAS 100BTR Only)

The STAGEPAS 100BTR can be used without a power adaptor if the built-in battery is charged.

## Charging the battery

### 1 Connect the unit to power (see “Connecting the unit to power” on page 10).

When you connect the power cord to an AC outlet, the unit automatically starts charging the battery. While the battery is being charged, the [POWER] LED flashes green.

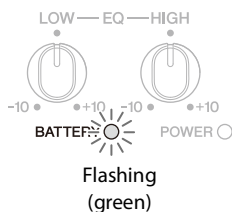

#### NOTE

- The battery is charged regardless of the on/off status of the power switch.
- While audio is being input, the charging process is interrupted. One minute after the audio input stops, the charging process resumes.

### 2 Make sure that the [BATTERY] LED lights green steadily (indicating that the battery is fully charged).

BATTERY Lit steadily (green)

Typically, charging the battery fully takes about two and a half hours.

#### NOTICE

- In an excessively warm or cold environment, the battery might not be charged.
- To maintain battery function, charge the battery once every half year.

## [BATTERY] LED status

### With the power adaptor

LED	Status
Lit steadily (green)	Fully charged
Flashing (green)	Charging
Flashing slowly (red)	Since the battery is located in an excessively warm or cold environment, the battery protection function has been activated, preventing the battery from being charged.
Flashing rapidly (red)	Battery abnormality

In case of battery abnormality, turn off the power to the unit, disconnect the power adaptor, and contact your Yamaha dealer.

### Without the power adaptor

LED	Status	A guide to the amount of remaining battery charge
Lit steadily (green)	Fully charged	100%
Lit steadily (yellow)	Sufficiently charged	90 – 51%
Flashing (yellow)	Minimal amount of remaining battery charge	50 – 1%
Flashing (red)	Zero amount of remaining battery charge	0%
Off*	Battery abnormality	—

\* If the LED turns off, the battery abnormality may be caused by one of the following reasons:

- The battery is being used in an excessively warm or cold environment.
- The battery protection function has been activated.
- The battery is defective (deep discharge).
- The battery is over-discharged.

If the battery is not charged completely even after the charging process is complete, or if for some reason the battery cannot be charged, the battery life may be expired. Please contact your Yamaha dealer.

# Troubleshooting

---

## Power does not turn on.

- You did not firmly and securely connect the power cord and power adaptor.
- (STAGEPAS 100BTR only) The built-in battery is not charged.  
If you are using the STAGEPAS 100BTR without the power adaptor, make sure that the built-in battery is sufficiently charged.

## Power shuts down suddenly.

If heat dissipation is insufficient, the power shuts down to protect the system from overheating. Arrange the ventilation for better cooling, then turn the power on again.

## No sound is heard.

- The devices, such as a microphone or a musical instrument, are not connected to the input jacks properly.
- The volume level of the connected musical instrument or audio device is not sufficiently raised.  
Check the volume level of the connected musical instrument or audio device.
- You are using a condenser microphone.  
Use a dynamic microphone. Power cannot be supplied to a directly-connected condenser microphone. Therefore, you will be unable to use it.
- The input signal level is excessive.  
If the internal power amplifier section is overloaded, the amplifier will be muted to protect its circuits. The unit will automatically reset itself after a while.

## Sound is distorted or noise is produced.

- The [LEVEL] control for each channel is raised too high.
- The [MIC/LINE] switch is set to the MIC position.  
If the input level from the source is high, setting the [MIC/LINE] switch to the MIC position may result in a distorted sound. Set the switch to the LINE position.
- The volume of the connected device is too high.  
Lower the volume of the external device.
- The power cord or the power adaptor is located close to the input cable.  
Locate them away from the input cable.

## Sound is not loud enough.

- The [LEVEL] control for each channel is set too low.
- The [MIC/LINE] switch of the corresponding channel is set to the LINE position.  
Turn the [LEVEL] control to the minimum (zero). Set the switch to the MIC position, then slowly raise the [LEVEL] control.
- The volume of the connected device is too low.  
Raise the volume of the external device.

## The high-range sounds and low-range sounds are unbalanced.

- The [EQ] controls are raised or lowered too much.  
Set the [EQ] controls to the center position.

## Cannot connect Bluetooth/Bluetooth audio sound cuts intermittently.

- The unit may be connected to a different Bluetooth device.  
Disconnect the current Bluetooth connection, and then connect to the desired Bluetooth device.
- Your Bluetooth device may not support the A2DP profile.  
Use a Bluetooth device that supports A2DP.
- The unit may be located in the vicinity of a device that emits electro-magnetic waves at a frequency of 2.4 GHz (such as a wireless microphone transmitter, wireless LAN device, microwave oven, etc.).  
Locate the STAGEPAS 100 unit away from any device that emits electro-magnetic waves.  
If your Bluetooth device also features a wireless LAN function, turn off the function, and use only the Bluetooth function.

### **(STAGEPAS 100BTR only)**

#### **The battery cannot be charged.**

- The battery is being used in an excessively warm or cold environment.

Move the STAGEPAS 100BTR to a location at room temperature and do not use it until the built-in battery achieves a suitable temperature.

If the battery still cannot be charged after a sufficient amount of time has passed, an error may have occurred with the built-in battery. Please contact your Yamaha dealer.

#### **The amount of remaining battery charge decreases very quickly.**

The built-in battery life may be expiring. Please contact your Yamaha dealer.

- To maintain battery function, charge the battery once every half year.
- The battery has a limited life. The battery capacity decreases little by little over time and is affected by frequency of usage.
- The battery life varies depending on different storage methods, operating conditions and environment.

If a problem persists, please contact your Yamaha dealer.



# Specifications

General		
System type	2 way, Coaxial bi-amp powered speaker, Bass-reflex type	
Frequency range (-10 dB)	70 Hz – 20 kHz	
Crossover	FIR-X, 1.8 kHz	
Measured maximum SPL (Peak) IEC noise @ 1 m	120 dB SPL	
Transducer		
LF	Diameter	6.5" Cone
	Voice coil	1.7"
	Magnet	Ferrite
HF	Diaphragm	1.4"
	Type	1" throat compression driver coaxial
	Magnet	Ferrite
Enclosure		
Material, Color	Plastic (PP), Black	
Dimensions (W × H × D, with handle and foot)	239 × 310 × 215 mm	
Net weight (without AC adaptor)	5.2 kg (STAGEPAS 100), 5.5 kg (STAGEPAS 100BTR)	
Screw threads (bottom of handle)	1 × 3/8" depth 12 mm (for 1 × 3/8" × 9–11 mm screw)	
Included in the package	Power cord × 1, AC adaptor (PA-500) × 1, Owner's manual (this manual) × 1	
Optional accessories	BAG-STP100 (Carrying bag)	
Amplifier		
Amplifier type	Class-D	
Power rating *1	Dynamic	100 W
	Continuous	60 W
Cooling	Natural cooling (no fan)	
Connectors	Input	Input 1: Combo × 1, Input 2: Combo × 1, INPUT3: Stereo mini × 1 (Unbalanced)
	Output	Output: XLR3-32 × 1 (CH 1 – CH 3 Mix)
	DC input	DC inlet × 1 (24 V), EIAJ RC5322 type
Input impedance	INPUT1, 2: LINE: 5.4 kΩ, MIC: 5.4 kΩ INPUT2 (Hi-Z SW ON): LINE, MIC: 1 MΩ INPUT3: 10 kΩ	
Input sensitivity (VOLUME: Maximum)	INPUT1, 2: LINE: -6 dBu, MIC: -36 dBu INPUT3: -6 dBu	
Maximum input level	INPUT1, 2: LINE: +20 dBu, MIC: -10 dBu INPUT3: +20 dBu	
Bluetooth	Profile: A2DP Codec: SBC, MPEG4-AAC Version: Ver. 5.0 Content protection method: SCMS-T Wireless output: Class 1 Transmission frequency range: 2,402–2,480 MHz Maximum output power (EIRP): 9 dBm (8 mW)	
Idle power consumption	10 W (Idle), 30 W (1/8 power)	

AC adaptor	
Power requirements	100 V – 240 V, 50/60 Hz
Output	24.0 V, 2.5 A
Dimensions	Adaptor: 150 × 65 × 33 mm, DC cable length: 1.5 m
Net weight (without AC cable)	0.4 kg
Battery (Built in STAGEPAS 100BTR only)	
Battery type	Rechargeable lithium ion battery pack
Capacity	60 Wh
Operating time	Maximum 6 hours, 1/16 power continuous 5 hours
Charging time* <sup>2</sup>	Approx. 2.5 hours
Charging Temperature	0 – 40°C

0 dBu = 0.775 Vrms.

\*1 Power rating (120 V, 25°C). This is total value of individual output power.  
This value is measured by releasing the software protection.

Dynamic: Total peak power of individual outputs. Measured at minimum load impedance, with protection released.  
Continuous: Measured at nominal impedance, with protection activated.

\*2 Battery charging time is an estimate for fully charging a completely exhausted battery. The time varies depending on the remaining battery level and ambient temperature.

The contents of this manual apply to the latest specifications as of the publishing date. To obtain the latest manual, access the Yamaha website then download the manual file.

## Dimensions

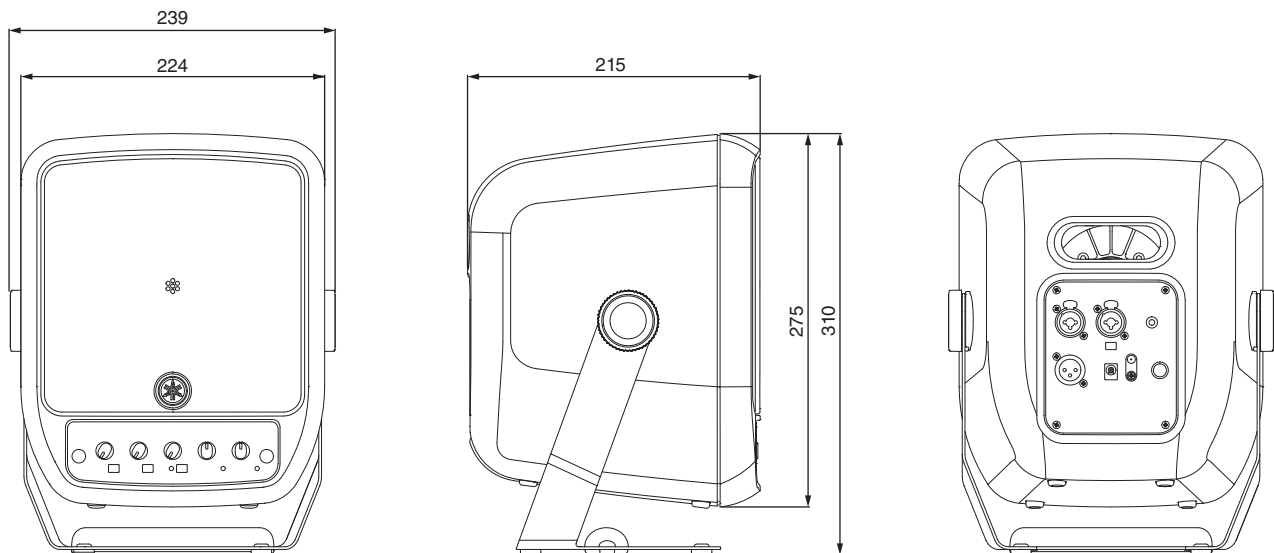

Unit: mm

## For European Union and United Kingdom

<b>EN</b>	<b>SIMPLIFIED EU DECLARATION OF CONFORMITY / SIMPLIFIED UK DECLARATION OF CONFORMITY</b>
<p>Hereby, Yamaha Music Europe GmbH declares that the radio equipment type [STAGEPAS 100BTR, STAGEPAS 100] is in compliance with Directive 2014/53/EU and the radio equipment regulations of UK. The full text of the EU declaration of conformity and the UK declaration of conformity are available at the following internet address: <a href="https://europe.yamaha.com/en/support/compliance/doc.html">https://europe.yamaha.com/en/support/compliance/doc.html</a></p>	
<b>FR</b>	<b>DECLARATION UE DE CONFORMITE SIMPLIFIEE</b>
<p>Le soussigné, Yamaha Music Europe GmbH, déclare que l'équipement radioélectrique du type [STAGEPAS 100BTR, STAGEPAS 100] est conforme à la directive 2014/53/UE. Le texte complet de la déclaration UE de conformité est disponible à l'adresse internet suivante: <a href="https://europe.yamaha.com/en/support/compliance/doc.html">https://europe.yamaha.com/en/support/compliance/doc.html</a></p>	
<b>DE</b>	<b>VEREINFACHTE EU-KONFORMITÄTSERKLÄRUNG</b>
<p>Hiermit erklärt Yamaha Music Europe GmbH, dass der Funkanlagentyp [STAGEPAS 100BTR, STAGEPAS 100] der Richtlinie 2014/53/EU entspricht. Der vollständige Text der EU-Konformitätserklärung ist unter der folgenden Internetadresse verfügbar: <a href="https://europe.yamaha.com/en/support/compliance/doc.html">https://europe.yamaha.com/en/support/compliance/doc.html</a></p>	
<b>SV</b>	<b>FÖRENKLAD EU-FÖRSÄKRAN OM ÖVERENSSTÄMMELSE</b>
<p>Härmed försäkrar Yamaha Music Europe GmbH att denna typ av radioutrustning [STAGEPAS 100BTR, STAGEPAS 100] överensstämmer med direktiv 2014/53/EU. Den fullständiga texten till EU-försäkran om överensstämmelse finns på följande webbadress: <a href="https://europe.yamaha.com/en/support/compliance/doc.html">https://europe.yamaha.com/en/support/compliance/doc.html</a></p>	
<b>IT</b>	<b>DICHIARAZIONE DI CONFORMITÀ UE SEMPLIFICATA</b>
<p>Il fabbricante, Yamaha Music Europe GmbH, dichiara che il tipo di apparecchiatura radio [STAGEPAS 100BTR, STAGEPAS 100] è conforme alla direttiva 2014/53/UE. Il testo completo della dichiarazione di conformità UE è disponibile al seguente indirizzo Internet: <a href="https://europe.yamaha.com/en/support/compliance/doc.html">https://europe.yamaha.com/en/support/compliance/doc.html</a></p>	
<b>ES</b>	<b>DECLARACIÓN UE DE CONFORMIDAD SIMPLIFICADA</b>
<p>Por la presente, Yamaha Music Europe GmbH declara que el tipo de equipo radioeléctrico [STAGEPAS 100BTR, STAGEPAS 100] es conforme con la Directiva 2014/53/UE. El texto completo de la declaración UE de conformidad está disponible en la dirección Internet siguiente: <a href="https://europe.yamaha.com/en/support/compliance/doc.html">https://europe.yamaha.com/en/support/compliance/doc.html</a></p>	
<b>PT</b>	<b>DECLARAÇÃO UE DE CONFORMIDADE SIMPLIFICADA</b>
<p>O(a) abaixo assinado(a) Yamaha Music Europe GmbH declara que o presente tipo de equipamento de rádio [STAGEPAS 100BTR, STAGEPAS 100] está em conformidade com a Diretiva 2014/53/UE. O texto integral da declaração de conformidade está disponível no seguinte endereço de Internet: <a href="https://europe.yamaha.com/en/support/compliance/doc.html">https://europe.yamaha.com/en/support/compliance/doc.html</a></p>	
<b>NL</b>	<b>VEREENVOUDIGDE EU-CONFORMITEITSVERKLARING</b>
<p>Hierbij verklaar ik, Yamaha Music Europe GmbH, dat het type radioapparatuur [STAGEPAS 100BTR, STAGEPAS 100] conform is met Richtlijn 2014/53/EU. De volledige tekst van de EU-conformiteitsverklaring kan worden geraadpleegd op het volgende internetadres: <a href="https://europe.yamaha.com/en/support/compliance/doc.html">https://europe.yamaha.com/en/support/compliance/doc.html</a></p>	
<b>BG</b>	<b>ОПРОСТЕНА ЕС ДЕКЛАРАЦИЯ ЗА СЪОТВЕТСТВИЕ</b>
<p>С настоящото Yamaha Music Europe GmbH декларира, че този тип радиосъоръжение [STAGEPAS 100BTR, STAGEPAS 100] е в съответствие с Директива 2014/53/ЕС. Цялостният текст на ЕС декларацията за съответствие може да се намери на следния интернет адрес: <a href="https://europe.yamaha.com/en/support/compliance/doc.html">https://europe.yamaha.com/en/support/compliance/doc.html</a></p>	
<b>CS</b>	<b>ZJEDNODUŠENÉ EU PROHLÁŠENÍ O SHODĚ</b>
<p>Tímto Yamaha Music Europe GmbH prohlašuje, že typ rádiového zařízení [STAGEPAS 100BTR, STAGEPAS 100] je v souladu se směrnici 2014/53/EU. Úplné znění EU prohlášení o shodě je k dispozici na této internetové adrese: <a href="https://europe.yamaha.com/en/support/compliance/doc.html">https://europe.yamaha.com/en/support/compliance/doc.html</a></p>	
<b>DA</b>	<b>FORENKLET EU-OVERENSSTEMMELSESERKLÆRING</b>
<p>Hermed erklærer Yamaha Music Europe GmbH, at radioudstyrstypen [STAGEPAS 100BTR, STAGEPAS 100] er i overensstemmelse med direktiv 2014/53/EU. EU-overensstemmelseserklæringens fulde tekst kan findes på følgende internetadresse: <a href="https://europe.yamaha.com/en/support/compliance/doc.html">https://europe.yamaha.com/en/support/compliance/doc.html</a></p>	

<b>ET</b>	<b>LIHTSUSTATUD ELI VASTAVUSDEKLARATSIOON</b>
	Käesolevaga deklareerib Yamaha Music Europe GmbH, et käesolev raadioseadme tüüp [STAGEPAS 100BTR, STAGEPAS 100] vastab direktiivi 2014/53/EL nõuetele. ELi vastavusdeklaratsiooni täielik tekst on kättesaadav järgmisel internetiaadressil: <a href="https://europe.yamaha.com/en/support/compliance/doc.html">https://europe.yamaha.com/en/support/compliance/doc.html</a>
<b>EL</b>	<b>ΑΠΛΟΥΣΤΕΥΜΕΝΗ ΔΗΛΩΣΗ ΣΥΜΜΟΡΦΩΣΗΣ ΕΕ</b>
	Με την παρούσα ο/η Yamaha Music Europe GmbH, δηλώνει ότι ο ραδιοεξοπλισμός [STAGEPAS 100BTR, STAGEPAS 100] πληροί την οδηγία 2014/53/ΕΕ. Το πλήρες κείμενο της δήλωσης συμμόρφωσης ΕΕ διατίθεται στην ακόλουθη ιστοσελίδα στο διαδίκτυο: <a href="https://europe.yamaha.com/en/support/compliance/doc.html">https://europe.yamaha.com/en/support/compliance/doc.html</a>
<b>HR</b>	<b>POJEDNOSTAVLJENA EU IZJAVA O SUKLADNOSTI</b>
	Yamaha Music Europe GmbH ovime izjavljuje da je radijska oprema tipa [STAGEPAS 100BTR, STAGEPAS 100] u skladu s Direktivom 2014/53/EU. Cjeloviti tekst EU izjave o sukladnosti dostupan je na sljedećoj internetskoj adresi: <a href="https://europe.yamaha.com/en/support/compliance/doc.html">https://europe.yamaha.com/en/support/compliance/doc.html</a>
<b>LV</b>	<b>VIENKĀRŠOTA ES ATBILSTĪBAS DEKLARĀCIJA</b>
	Ar šo Yamaha Music Europe GmbH deklarē, ka radioiekārta [STAGEPAS 100BTR, STAGEPAS 100] atbilst Direktīvai 2014/53/ES. Pilns ES atbilstības deklarācijas teksts ir pieejams šādā interneta vietnē: <a href="https://europe.yamaha.com/en/support/compliance/doc.html">https://europe.yamaha.com/en/support/compliance/doc.html</a>
<b>LT</b>	<b>SUPAPRASTINTA ES ATITIKTIES DEKLARACIJA</b>
	Aš, Yamaha Music Europe GmbH, patvirtinu, kad radijo įrenginių tipas [STAGEPAS 100BTR, STAGEPAS 100] atitinka Direktyvą 2014/53/ES. Visas ES atitikties deklaracijos tekstas prieinamas šiuo interneto adresu: <a href="https://europe.yamaha.com/en/support/compliance/doc.html">https://europe.yamaha.com/en/support/compliance/doc.html</a>
<b>HU</b>	<b>EGYSZERŰSÍTETT EU-MEGFELELŐSÉGI NYILATKOZAT</b>
	Yamaha Music Europe GmbH igazolja, hogy a [STAGEPAS 100BTR, STAGEPAS 100] típusú rádióberendezés megfelel a 2014/53/ EU irányelvnek. Az EU-megfelelőségi nyilatkozat teljes szövege elérhető a következő internetes címen: <a href="https://europe.yamaha.com/en/support/compliance/doc.html">https://europe.yamaha.com/en/support/compliance/doc.html</a>
<b>PL</b>	<b>UPROSZCZONA DEKLARACJA ZGODNOŚCI UE</b>
	Yamaha Music Europe GmbH niniejszym oświadcza, że typ urządzenia radiowego [STAGEPAS 100BTR, STAGEPAS 100] jest zgodny z dyrektywą 2014/53/UE. Pełny tekst deklaracji zgodności UE jest dostępny pod następującym adresem internetowym: <a href="https://europe.yamaha.com/en/support/compliance/doc.html">https://europe.yamaha.com/en/support/compliance/doc.html</a>
<b>RO</b>	<b>DECLARAȚIA UE DE CONFORMITATE SIMPLIFICATĂ</b>
	Prin prezenta, Yamaha Music Europe GmbH declară că tipul de echipamente radio [STAGEPAS 100BTR, STAGEPAS 100] este în conformitate cu Directiva 2014/53/UE. Textul integral al declarației UE de conformitate este disponibil la următoarea adresă internet: <a href="https://europe.yamaha.com/en/support/compliance/doc.html">https://europe.yamaha.com/en/support/compliance/doc.html</a>
<b>SK</b>	<b>ZJEDNODUŠENÉ EÚ VYHLÁSENIE O ZHODE</b>
	Yamaha Music Europe GmbH týmto vyhlasuje, že rádiové zariadenie typu [STAGEPAS 100BTR, STAGEPAS 100] je v súlade so smernicou 2014/53/EÚ. Úplné EÚ vyhlásenie o zhode je k dispozícii na tejto internetovej adrese: <a href="https://europe.yamaha.com/en/support/compliance/doc.html">https://europe.yamaha.com/en/support/compliance/doc.html</a>
<b>SL</b>	<b>POENOSTAVLJENA IZJAVA EU O SKLADNOSTI</b>
	Yamaha Music Europe GmbH potrjuje, da je tip radijske opreme [STAGEPAS 100BTR, STAGEPAS 100] skladen z Direktivo 2014/53/ EU. Celotno besedilo izjave EU o skladnosti je na voljo na naslednjem spletnem naslovu: <a href="https://europe.yamaha.com/en/support/compliance/doc.html">https://europe.yamaha.com/en/support/compliance/doc.html</a>
<b>FI</b>	<b>YKSINKERTAISTETTU EU-VAATIMUSTENMUKAISUUSVAKUUTUS</b>
	Yamaha Music Europe GmbH vakuuttaa, että radiolaitetyypin [STAGEPAS 100BTR, STAGEPAS 100] on direktiivin 2014/53/EU mukainen. EU-vaatimustenmukaisuusvakuutuksen täysimittainen teksti on saatavilla seuraavassa internetosoitteessa: <a href="https://europe.yamaha.com/en/support/compliance/doc.html">https://europe.yamaha.com/en/support/compliance/doc.html</a>
<b>TR</b>	<b>BASİTLEŞTİRİLMİŞ AVRUPA BİRLİĞİ UYGUNLUK BİLDİRİMİ</b>
	İşbu belge ile, Yamaha Music Europe GmbH, radyo cihaz tipinin [STAGEPAS 100BTR, STAGEPAS 100], Direktif 2014/53/ AB'ye uygunluğunu beyan eder. AB uyumu beyanının tam metni aşağıdaki internet adresinden edinilebilir: <a href="https://europe.yamaha.com/en/support/compliance/doc.html">https://europe.yamaha.com/en/support/compliance/doc.html</a>



## AC ADAPTOR PA-500

### Energy Efficiency Information for customers in European Economic Area (EEA), Switzerland and Turkey

<b>Energy Efficiency Information:</b> AC adaptor PA-500 / Input voltage : 230 V / Input AC frequency : 50 Hz / Output voltage (DC) : 24.0 V / Output current : 2.5 A / Output power : 60.0 W / Average active efficiency : 89.97 % / Efficiency at low load : 87.64 % / No-load power consumption : 0.1234 W	<b>English</b>
<b>Informationen zur Energieeffizienz:</b> Netzadapter PA-500 / Eingangsspannung: 230 V / Netzfrequenz: 50 Hz / Ausgangsspannung (U=): 24,0 V / Ausgangsstrom: 2,5 A / Ausgangsleistung: 60,0 W / Durchschnittliche Effizienz (aktiv): 89,97 % / Effizienz bei niedriger Last: 87,64 % / Stromverbrauch ohne Last: 0,1234 W	<b>Deutsch</b>
<b>Informations concernant l'efficacité énergétique :</b> Adaptateur secteur PA-500 / Tension d'entrée : 230 V / Fréquence d'entrée : 50 Hz / Tension de sortie (CC) : 24,0 V / Courant de sortie : 2,5 A / Puissance de sortie : 60,0 W / Efficacité moyenne en mode actif : 89,97 % / Efficacité à faible charge : 87,64 % / Consommation électrique sans charge : 0,1234 W	<b>Français</b>
<b>Informatie over energie-efficiëntie:</b> Netadapter PA-500 / Ingangsspanning: 230 V / Ingangsfrequentie: 50 Hz / Uitgangsspanning (DC): 24,0 V / Uitgangsstroom: 2,5 A / Uitgangsvermogen: 60,0 W / Gemiddelde actieve efficiëntie: 89,97% / Efficiëntie bij lage belasting: 87,64% / Stroomverbruik bij geen belasting: 0,1234 W	<b>Nederlands</b>
<b>Información de eficiencia energética:</b> Adaptador de CA PA-500 / Tensión de entrada: 230 V / Frecuencia de CA de entrada: 50 Hz / Tensión de salida (CC): 24,0 V / Corriente de salida: 2,5 A / Potencia de salida: 60,0 W / Eficiencia activa media: 89,97 % / Eficiencia con carga baja: 87,64 % / Consumo de energía sin carga: 0,1234 W	<b>Español</b>
<b>Informazioni sull'efficienza energetica:</b> Adattatore CA PA-500 / Tensione in ingresso: 230 V / Frequenza CA ingresso: 50 Hz / Tensione in uscita (CC): 24,0 V / Corrente di uscita: 2,5 A / Potenza di uscita: 60,0 W / Efficienza attiva media: 89,97 % / Efficienza a carico ridotto: 87,64 % / Consumo elettrico senza carico: 0,1234 W	<b>Italiano</b>
<b>Informações sobre eficiência de energia:</b> Adaptador CA PA-500 / Tensão de entrada: 230 V / Frequência de CA de entrada: 50 Hz / Tensão de saída (CC): 24,0 V / Corrente de saída: 2,5 A / Potência de saída: 60,0 W / Média de eficiência ativa: 89,97% / Eficiência com baixa carga: 87,64% / Consumo de energia sem carga: 0,1234 W	<b>Português</b>
<b>Πληροφορίες ενεργειακής απόδοσης:</b> Προσαρμογέας AC PA-500 / Τάση εισόδου: 230 V / Συχνότητα εισόδου AC: 50 Hz / Τάση εξόδου (DC): 24,0 V / Ρεύμα εξόδου: 2,5 A / Ισχύς εξόδου: 60,0 W / Μέση ενεργός απόδοση: 89,97% / Απόδοση σε χαμηλό φορτίο: 87,64% / Κατανάλωση ισχύος άνευ φορτίου: 0,1234 W	<b>Ελληνικά</b>
<b>Information om energieeffektivitet:</b> Nätadapter PA-500 / Inspänning: 230 V / Växelströmsfrekvens in: 50 Hz / Utspänning (Likström): 24,0 V / Utgående ström: 2,5 A / Uteffekt: 60,0 W / Genomsnittlig aktiv effektivitet: 89,97 % / Effektivitet vid låg belastning: 87,64 % / Energiförbrukning utan belastning: 0,1234 W	<b>Svenska</b>
<b>Oplysninger om energieffektivitet:</b> AC-adaptor PA-500/indgangsspænding: 230 V/indgangs-AC-frekvens: 50 Hz/udgangsspænding (DC): 24,0 V/udgangsstrøm: 2,5 A/udgangseffekt: 60,0 W/ gennemsnitlig aktiv effektivitet: 89,97 %/effektivitet ved lav belastning: 87,64 %/strømforbrug ved ingen belastning: 0,1234 W	<b>Dansk</b>
<b>Energiatohokkustiedot:</b> Verkkolaite PA-500 / Tulojännite : 230 V / Tulojännitteen taajuus : 50 Hz / Lähtöjännite (DC) : 24,0 V / Lähtövirta : 2,5 A / Lähtöteho : 60,0 W / Keskimääräinen tehokkuus käytössä : 89,97 % / Tehokkuus pienellä kuormalla : 87,64 % / Kulutus kuormittamattomana : 0,1234 W	<b>Suomi</b>
<b>Informacje o efektywności energetycznej:</b> Zasilacz sieciowy PA-500 / Napięcie wyjściowe: 230 V / Częstotliwość napięcia zasilania prądem zmiennym: 50 Hz / Napięcie wyjściowe (DC): 24,0 V / Prąd wyjściowy: 2,5 A / Maksymalna wyjściowa: 60,0 W / Średnia sprawność robocza: 89,97 % / Sprawność przy niskim poziomie obciążenia: 87,64% / Zużycie energii bez obciążenia: 0,1234 W	<b>Polski</b>
<b>Informace o energetické účinnosti:</b> Adaptér napájení PA-500 / Vstupní napětí: 230 V / Vstupní frekvence střídavého proudu: 50 Hz / Výstupní napětí (DC): 24,0 V / Výstupní proud: 2,5 A / Výstupní výkon: 60,0 W / Průměrná účinnost v aktivním režimu: 89,97 % / Účinnost při nízké zátěži: 87,64 % / Spotřeba ve stavu bez zátěže: 0,1234 W	<b>Čeština</b>
<b>Energiahatékonyági adatok:</b> PA-500 hálózati adapter / Beviteli feszültség: 230 V / Beviteli hálózati frekvencia: 50 Hz / Kimeneti feszültség (DC): 24,0 V / Kimenő áramerősség: 2,5 A / Kimeneti teljesítmény: 60,0 W / Átlagos aktív teljesítmény: 89,97% / Hatékonyág alacsony töltésnél: 87,64% / Teljesítményfelvétel nem töltöttségénél: 0,1234 W	<b>Magyar</b>
<b>Energiatõhususe teave:</b> AC-adapter PA-500 / Sisendpinge: 230 V / Sisendi voolusagedus: 50 Hz / Väljundpinge (DC): 24,0 V / Väljundvool: 2,5 A / Väljundvõimsus: 60,0 W / Tõõseisundi keskmine kasutegur: 89,97% / Tõõhusus väikese koormuse juures: 87,64% / Energiatarbimine koormamata seisundis: 0,1234 W	<b>Eesti</b>
<b>Informācija par energoefektivitāti:</b> Maiņstrāvas adapteris PA-500 / Ieejas spriegums: 230 V / Ieejas maiņstrāvas frekvence: 50 Hz / Izejas spriegums (līdzstrāva): 24,0 V / Izejas strāva: 2,5 A / Izejas jauda: 60,0 W / Vidējā aktīvā efektivitāte: 89,97 % / Efektivitāte ar mazu slodzi: 87,64 % / Enerģijas patēriņš bez slodzes: 0,1234 W	<b>Latviešu</b>
<b>Energijos naudojimo efektyvumo informacija:</b> Kintamosios srovės adapteris PA-500 / Įėjimo įtampa: 230 V / Įėjimo kintamosios srovės dažnis: 50 Hz / Išėjimo įtampa (nuolatinė srovė): 24,0 V / Išėjimo srovė: 2,5 A / Išvesties galia: 60,0 W / Vidutinis efektyvumas aktyviojo režimo: 89,97 % / Efektyvumas esant mažai apkrovai: 87,64 % / Energijos sąnaudos be apkrovos: 0,1234 W	<b>Lietuvių</b>
<b>Informácie o energetickej účinnosti:</b> Adaptér napájania PA-500 / Vstupné napätie: 230 V / Vstupná frekvencia striedavého prúdu: 50 Hz / Výstupné napätie (DC): 24,0 V / Výstupný prúd: 2,5 A / Výstupný výkon: 60,0 W / Priemerná účinnosť v aktivnom režime: 89,97 % / Účinnosť pri nízkej záťaži: 87,64 % / Spotreba v stave bez záťaže: 0,1234 W	<b>Slovenčina</b>
<b>Podatki o energetski učinkovitosti:</b> Električni napajalnik PA-500 / Vhodna napetost: 230 V / Vhodna frekvenca izmeničnega toka: 50 Hz / Izhodna napetost (enosmerni tok): 24,0 V / Izhodni tok: 2,5 A / Izhodna moč: 60,0 W / Povprečna učinkovitost – v času delovanja: 89,97 % / Učinkovitost pri nižji obremenitvi: 87,64 % / Poraba energije – brez obremenitve: 0,1234 W	<b>Slovenščina</b>
<b>Информация за енергийна ефективност:</b> Адаптер за променливотоково захранване PA-500 / Входно напрежение : 230 V / Входна честота (променлив ток) : 50 Hz / Изходно напрежение (постоянен ток) : 24,0 V / Изходен ток : 2,5 A / Изходна мощност : 60,0 W / Средна активна ефективност : 89,97 % / Ефективност при ниско натоварване : 87,64 % / Консумация на енергия без натоварване : 0,1234 W	<b>Български</b>
<b>Informații privind eficiența energetică:</b> Adaptor CA PA-500 / Tensiune de intrare: 230 V / Frecvență CA de intrare: 50 Hz / Tensiune de ieșire (CC): 24,0 V / Curent de ieșire: 2,5 A / Putere de ieșire: 60,0 W / Eficiență activă medie: 89,97 % / Eficiență la sarcină redusă: 87,64 % / Consum electric fără sarcină: 0,1234 W	<b>Română</b>
<b>Informacije o energetskoj učinkovitosti:</b> Prilagodnik izmjeničnog napajanja PA-500 / Ulazni napon: 230 V / Ulazna frekvencija izmjeničnog napajanja: 50 Hz / Izlazni napon (istosmjerna struja): 24,0 V / Izlazna struja: 2,5 A / Izlazna snaga: 60,0 W / Prosječna aktivna učinkovitost: 89,97 % / Učinkovitost pri niskom opterećenju: 87,64 % / Potrošnja energije bez opterećenja: 0,1234 W	<b>Hrvatski</b>
<b>Enerji Verimliliği Bilgileri:</b> AC adaptörü PA-500 / Giriş gerilimi : 230 V / Giriş AC frekansı : 50 Hz / Çıkış gerilimi (DC) : 24,0 V / Çıkış akımı : 2,5 A / Çıkış gücü : 60,0 W / Ortalama etkin verimlilik : %89,97 / Düşük yükte verimlilik : %87,64 / Yüksüz güç tüketimi : 0,1234 W	<b>Türkçe</b>

# Important Notice: Guarantee Information for customers in European Economic Area (EEA) and Switzerland

<b>Important Notice: Guarantee Information for customers in EEA* and Switzerland</b> For detailed guarantee information about this Yamaha product, and Pan-EEA* and Switzerland warranty service, please either visit the website address below (Printable file is available at our website) or contact the Yamaha representative office for your country. * EEA: European Economic Area	<b>English</b>
<b>Wichtiger Hinweis: Garantie-Information für Kunden in der EWR* und der Schweiz</b> Für nähere Garantie-Information über dieses Produkt von Yamaha, sowie über den Pan-EWR*- und Schweizer Garantieservice, besuchen Sie bitte entweder die folgend angegebene Internetadresse (eine druckfähige Version befindet sich auch auf unserer Webseite), oder wenden Sie sich an den für Ihr Land zuständigen Yamaha-Vertrieb. *EWR: Europäischer Wirtschaftsraum	<b>Deutsch</b>
<b>Remarque importante: informations de garantie pour les clients de l'EEE et la Suisse</b> Pour des informations plus détaillées sur la garantie de ce produit Yamaha et sur le service de garantie applicable dans l'ensemble de l'EEE ainsi qu'en Suisse, consultez notre site Web à l'adresse ci-dessous (le fichier imprimable est disponible sur notre site Web) ou contactez directement Yamaha dans votre pays de résidence. * EEE : Espace Economique Européen	<b>Français</b>
<b>Belangrijke mededeling: Garantie-informatie voor klanten in de EER* en Zwitserland</b> Voor gedetailleerde garantie-informatie over dit Yamaha-product en de garantieservice in heel de EER* en Zwitserland, gaat u naar de onderstaande website (u vindt een afdrukbaar bestand op onze website) of neemt u contact op met de vertegenwoordiging van Yamaha in uw land. * EER: Europese Economische Ruimte	<b>Nederlands</b>
<b>Aviso importante: información sobre la garantía para los clientes del EEE* y Suiza</b> Para una información detallada sobre este producto Yamaha y sobre el soporte de garantía en la zona EEE* y Suiza, visite la dirección web que se incluye más abajo (la versión del archivo para imprimir esta disponible en nuestro sitio web) o póngase en contacto con el representante de Yamaha en su país. * EEE: Espacio Económico Europeo	<b>Español</b>
<b>Avviso importante: informazioni sulla garanzia per i clienti residenti nell'EEA* e in Svizzera</b> Per informazioni dettagliate sulla garanzia relativa a questo prodotto Yamaha e l'assistenza in garanzia nei paesi EEA* e in Svizzera, potete consultare il sito Web all'indirizzo riportato di seguito (è disponibile il file in formato stampabile) oppure contattare l'ufficio di rappresentanza locale della Yamaha. * EEA: Area Economica Europea	<b>Italiano</b>
<b>Aviso importante: informações sobre as garantias para clientes da AEE* e da Suíça</b> Para obter uma informação pormenorizada sobre este produto da Yamaha e sobre o serviço de garantia na AEE* e na Suíça, visite o site a seguir (o arquivo para impressão está disponível no nosso site) ou entre em contato com o escritório de representação da Yamaha no seu país. * AEE: Área Económica Européia	<b>Português</b>
<b>Σημαντική σημείωση: Πληροφορίες εγγύησης για τους πελάτες στον ΕΟΧ* και Ελβετία</b> Για λεπτομερείς πληροφορίες εγγύησης σχετικά με το παρόν προϊόν της Yamaha και την κάλυψη εγγύησης σε όλες τις χώρες του ΕΟΧ και την Ελβετία, επισκεφτείτε την παρακάτω ιστοσελίδα (Εκτυπώσιμη μορφή είναι διαθέσιμη στην ιστοσελίδα μας) ή απευθυνθείτε στην αντιπροσωπεία της Yamaha στη χώρα σας. * ΕΟΧ: Ευρωπαϊκός Οικονομικός Χώρος	<b>Ελληνικά</b>
<b>Viktigt: Garantiinformation för kunder i EES-området* och Schweiz</b> För detaljerad information om denna Yamahaprodukt samt garantiservice i hela EES-området* och Schweiz kan du antingen besöka nedanstående webbadress (en utskriftsvänlig fil finns på webbplatsen) eller kontakta Yamahas officiella representant i ditt land. * EES: Europeiska Ekonomiska Samarbetsområdet	<b>Svenska</b>
<b>Viktig merknad: Garantiinformasjon for kunder i EØS* og Sveits</b> Detaljert garantiinformasjon om dette Yamaha-produktet og garantiservice for hele EØS-området* og Sveits kan fås enten ved å besøke nettstedene nedenfor (utskriftsversjon finnes på våre nettsider) eller kontakte Yamahas kontoret i landet der du bor. *EØS: Det europeiske økonomiske samarbeidsområdet	<b>Norsk</b>
<b>Vigtig oplysning: Garantioplysninger til kunder i EØO* og Schweiz</b> De kan finde detaljerede garantioplysninger om dette Yamaha-produkt og den fælles garantiserviceordning for EØO* (og Schweiz) ved at besøge det websted, der er angivet nedenfor (der findes en fil, som kan udskrives, på vores websted), eller ved at kontakte Yamahas nationale repræsentationskontor i det land, hvor De bor. * EØO: Det Europæiske Økonomiske Område	<b>Dansk</b>
<b>Tärkeä ilmoitus: Takuutiedot Euroopan talousalueen (ETA)* ja Sveitsin asiakkaille</b> Tämän Yamaha-tuotteen sekä ETA-alueen ja Sveitsin takuuta koskevat yksityiskohtaiset tiedot saatte alla olevasta nettiosoitteesta. (Tulostettava tiedosto saatavissa sivustollamme.) Voitte myös ottaa yhteyttä paikalliseen Yamaha-edustajaan. *ETA: Euroopan talousalue	<b>Suomi</b>
<b>Ważne: Warunki gwarancyjne obowiązujące w EOG* i Szwajcarii</b> Aby dowiedzieć się więcej na temat warunków gwarancyjnych tego produktu firmy Yamaha i serwisu gwarancyjnego w całym EOG* i Szwajcarii, należy odwiedzić wskazaną poniżej stronę internetową (Plik gotowy do wydruku znajduje się na naszej stronie internetowej) lub skontaktować się z przedstawicielstwem firmy Yamaha w swoim kraju. * EOG — Europejski Obszar Gospodarczy	<b>Polski</b>
<b>Důležité oznámení: Záruční informace pro zákazníky v EHS* a ve Švýcarsku</b> Podrobné záruční informace o tomto produktu Yamaha a záručním servisu v celém EHS* a ve Švýcarsku naleznete na níže uvedené webové adrese (soubor k tisku je dostupný na našich webových stránkách) nebo se můžete obrátit na zastoupení firmy Yamaha ve své zemi. * EHS: Evropský hospodářský prostor	<b>Česky</b>
<b>Fontos figyelmeztetés: Garancia-információk az EGT* területén és Svájcban élő vásárlók számára</b> A jelen Yamaha termékre vonatkozó részletes garancia-információk, valamint az EGT*-re és Svájcra kiterjedő garanciális szolgáltatás tekintetében keresse fel webhelyünket az alábbi címen (a webhelyen nyomtatható fájl is talál), vagy pedig lépjen kapcsolatba az országában működő Yamaha képviselői irodával. * EGT: Európai Gazdasági Térség	<b>Magyar</b>
<b>Oluline märkus: Garantiiteave Euroopa Majanduspiirkonna (EMP)* ja Šveitsi klientidele</b> Täpsemate teabe saamiseks selle Yamaha toote garantii ning kogu Euroopa Majanduspiirkonna ja Šveitsi garantiiteeninduse kohta, külastage palun veebisaiti alljärgneval aadressil (meie saidil on saadaval printitav fail) või pöörduge Teie regiooni Yamaha esinduse poole. * EMP: Euroopa Majanduspiirkond	<b>Eesti keel</b>
<b>Svarīgs paziņojums: garantijas informācija klientiem EEZ* un Šveicē</b> Lai saņemtu detalizētu garantijas informāciju par šo Yamaha produktu, kā arī garantijas apkalpošanu EEZ* un Šveicē, lūdzu, apmeklējiet zemāk norādīto tīmekļa vietnes adresi (tīmekļa vietnē ir pieejams drukājams fails) vai sazinieties ar jūsu valsti apkalpojošo Yamaha pārstāvniecību. * EEZ: Eiropas Ekonomikas zona	<b>Latviešu</b>
<b>Dėmesio: informacija dėl garantijos pirkėjams EEE* ir Šveicarijoje</b> Jei reikia išsamios informacijos apie šį „Yamaha“ produktą ir jo techninę priežiūrą visoje EEE* ir Šveicarijoje, apsilankykite mūsų svetainėje toliau nurodytu adresu (svetainėje yra spausdintinas failas) arba kreipkitės į „Yamaha“ atstovybę savo šaliai. *EEE – Europos ekonominė erdvė	<b>Lietuvių kalba</b>
<b>Dôležité upozornenie: Informácie o záruke pre zákazníkov v EHP* a Švajčiarsku</b> Podrobné informácie o záruke týkajúce sa tohto produktu od spoločnosti Yamaha a garančnom servise v EHP* a Švajčiarsku nájdete na webovej stránke uvedenej nižšie (na našej webovej stránke je k dispozícii súbor na tlač) alebo sa obráťte na zástupcu spoločnosti Yamaha vo svojej krajine. * EHP: Európsky hospodársky priestor	<b>Slovenčina</b>
<b>Pomembno obvestilo: Informacije o garanciji za kupce v EGP* in Švici</b> Za podrobnejše informacije o tem Yamahinem izdelku ter garancijskem servisu v celotnem EGP in Švici, obiščite spletno mesto, ki je navedeno spodaj (natisljiva datoteka je na voljo na našem spletnem mestu), ali se obrnite na Yamahinega predstavnika v svoji državi. * EGP: Evropski gospodarski prostor	<b>Slovenščina</b>
<b>Важно съобщение: Информация за гаранцията за клиенти в ЕИП* и Швейцария</b> За подробна информация за гаранцията за този продукт на Yamaha и гаранционното обслужване в паневропейската зона на ЕИП* и Швейцария или посетете посочения по-долу уеб сайт (на нашия уеб сайт има файл за печат), или се свържете с представителния офис на Yamaha във вашата страна. * ЕИП: Европейско икономическо пространство	<b>Български език</b>
<b>Notificare importantă: Informații despre garanție pentru clienții din SEE* și Elveția</b> Pentru informații detaliate privind acest produs Yamaha și serviciul de garanție Pan-SEE* și Elveția, vizitați site-ul la adresa de mai jos (fișierul imprimabil este disponibil pe site-ul nostru) sau contactați biroul reprezentanței Yamaha din țara dumneavoastră. * SEE: Spațiul Economic European	<b>Limba română</b>
<b>Važna obavijest: Informacije o jamstvu za države EGP-a i Švicarske</b> Za detaljne informacije o jamstvu za ovaj Yamahin proizvod te jamstvenom servisu za cijeli EGP i Švicarsku, molimo Vas da posjetite web-stranicu navedenu u nastavku ili kontaktirate ovlaštenog Yamahinog dobavljača u svojoj zemlji. * EGP: Evropski gospodarski prostor	<b>Hrvatski</b>

<https://europe.yamaha.com/warranty/>

# MEMO

# Block Diagram / Schéma fonctionnel / 框图 / 方块图 / ブロックダイアグラム

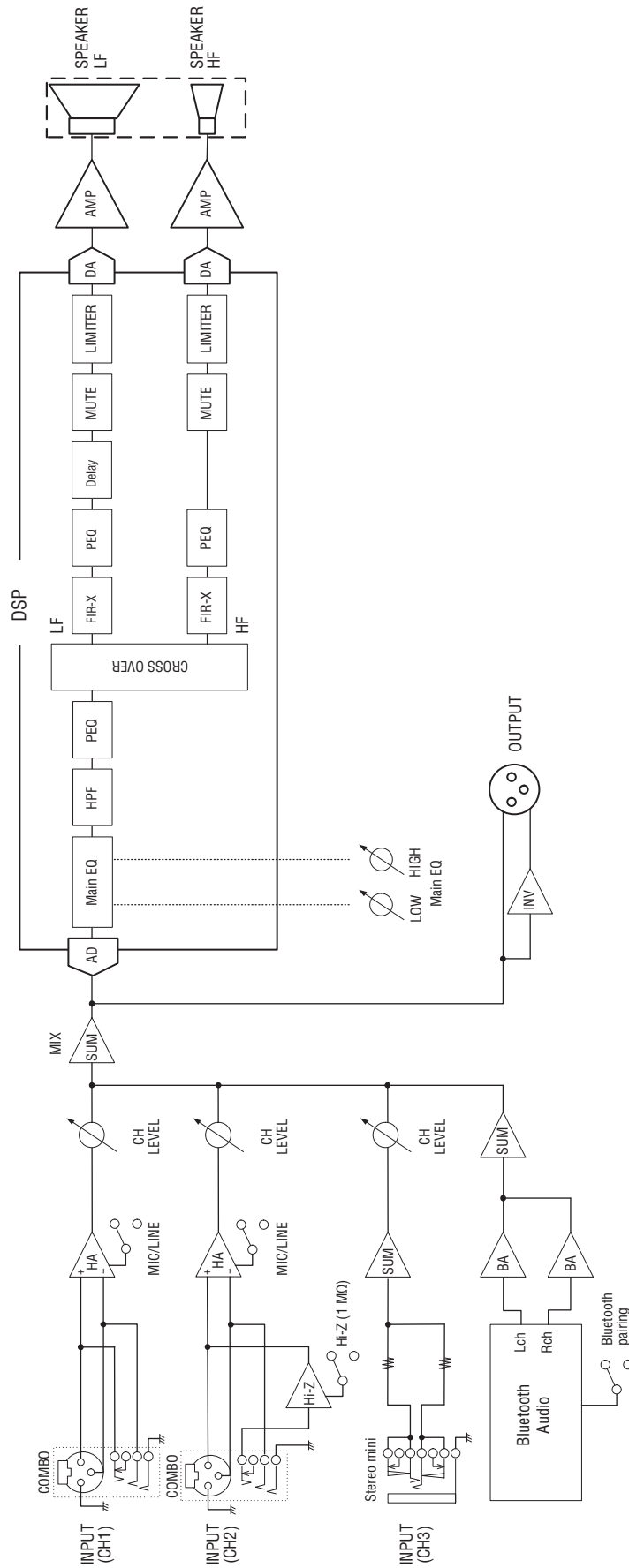



## ADDRESS LIST

### NORTH AMERICA

#### CANADA

**Yamaha Canada Music Ltd.**  
135 Milner Avenue, Toronto, Ontario,  
M1S 3R1, Canada  
Tel: +1-416-298-1311

#### U.S.A.

**Yamaha Corporation of America**  
6600 Orangethorpe Avenue, Buena Park, CA  
90620, U.S.A.  
Tel: +1-714-522-9011

### CENTRAL & SOUTH AMERICA

#### MEXICO

**Yamaha de México, S.A. de C.V.**  
Av. Insurgentes Sur 1647 Piso 9, Col. San José  
Insurgentes, Delegación Benito Juárez, CDMX,  
C.P. 03900, México  
Tel: +52-55-5804-0600

#### BRAZIL

**Yamaha Musical do Brasil Ltda.**  
Praça Professor José Lannes, 40-Cjs 21 e 22,  
Brooklin Paulista Novo CEP 04571-100 – São  
Paulo – SP, Brazil  
Tel: +55-11-3704-1377

#### ARGENTINA

**Yamaha Music Latin America, S.A.,  
Sucursal Argentina**  
Olga Cossettini 1553, Piso 4 Norte,  
Madero Este-C1107CEK,  
Buenos Aires, Argentina  
Tel: +54-11-4119-7000

#### PANAMA AND OTHER LATIN AMERICAN/CARIBBEAN REGIONS

**Yamaha Music Latin America, S.A.**  
Edif. Torre Banco General, Piso 7, Urbanización  
Marbella, Calle 47 y Aquilino de la Guardia,  
Ciudad de Panamá, República de Panamá  
Tel: +507-269-5311

### EUROPE

#### THE UNITED KINGDOM/IRELAND

**Yamaha Music Europe GmbH (UK)**  
Sherbourne Drive, Tilbrook, Milton Keynes,  
MK7 8BL, U.K.  
Tel: +44-1908-366700

#### GERMANY

**Yamaha Music Europe GmbH**  
Siemensstrasse 22-34, 25462 Rellingen, Germany  
Tel: +49-4101-303-0

#### SWITZERLAND/LIECHTENSTEIN

**Yamaha Music Europe GmbH, Branch  
Switzerland in Thalwil**  
Seestrasse 18a, 8800 Thalwil, Switzerland  
Tel: +41-44-3878080

#### AUSTRIA/BULGARIA/ CZECH REPUBLIC/HUNGARY/ ROMANIA/SLOVAKIA/SLOVENIA

**Yamaha Music Europe GmbH  
Branch Austria**  
Schleiergasse 20, 1100 Wien, Austria  
Tel: +43-1-60203900

#### POLAND

**Yamaha Music Europe  
Sp.z o.o. Oddział w Polsce**  
ul. Młynarska 48, 01-171 Warszawa, Poland  
Tel: +48-22-880-08-88

#### MALTA

**Olimpus Music Ltd.**  
Valletta Road, Mosta MST9010, Malta  
Tel: +356-2133-2093

### NETHERLANDS/BELGIUM/ LUXEMBOURG

**Yamaha Music Europe Branch Benelux**  
Wattbaan 1 3439ML Nieuwegein, The Netherlands  
Tel: +31-347-358040

#### FRANCE

**Yamaha Music Europe**  
7 rue Ambroise Croizat, Zone d'activités de Pariest,  
77183 Croissy-Beaubourg, France  
Tel: +33-1-6461-4000

#### ITALY

**Yamaha Music Europe GmbH, Branch Italy**  
Via Tinelli N.67/69 20855 Gerno di Lesmo (MB),  
Italy  
Tel: +39-039-9065-1

#### SPAIN/PORTUGAL

**Yamaha Music Europe GmbH Ibérica, Sucursal  
en España**  
Ctra. de la Coruña km. 17,200, 28231  
Las Rozas de Madrid, Spain  
Tel: +34-91-639-88-88

#### GREECE

**Philippos Nakas S.A. The Music House**  
19th klm. Leof. Lavriou 190 02 Peania – Attiki,  
Greece  
Tel: +30-210-6686168

#### SWEDEN/FINLAND/ICELAND

**Yamaha Music Europe GmbH Germany Filial  
Scandinavia**  
JA Wettergrensgata 1, 400 43 Göteborg, Sweden  
Tel: +46-31-89-34-00

#### DENMARK

**Yamaha Music Denmark,  
Fillial of Yamaha Music Europe GmbH, Tyskland**  
Generatorvej 8C, ST. TH. , 2860 Søborg, Denmark  
Tel: +45-44-92-49-00

#### NORWAY

**Yamaha Music Europe GmbH Germany -  
Norwegian Branch**  
c/o Box 30053, 400 43 Göteborg, Sweden  
Tel: +47-6716-7800

#### CYPRUS

**Yamaha Music Europe GmbH**  
Siemensstrasse 22-34, 25462 Rellingen, Germany  
Tel: +49-4101-303-0

#### RUSSIA

**Yamaha Music (Russia) LLC.**  
Room 37, entrance 7, bld. 7, Kievskaya street,  
Moscow, 121059, Russia  
Tel: +7-495-626-5005

#### OTHER EUROPEAN REGIONS

**Yamaha Music Europe GmbH**  
Siemensstrasse 22-34, 25462 Rellingen, Germany  
Tel: +49-4101-3030

### AFRICA

**Yamaha Music Gulf FZE**  
JAFZA-16, Office 512, P.O.Box 17328,  
Jebel Ali FZE, Dubai, UAE  
Tel: +971-4-801-1500

### MIDDLE EAST

#### TURKEY

**Ertekin Elektronik tic. ve san. as**  
Kagithane Ofis Park Baglar Cad.  
No: 14 D/6 Kagithane 34406  
ISTANBUL / TÜRKIYE  
Tel: +90-212-312-24-24

#### OTHER REGIONS

**Yamaha Music Gulf FZE**  
JAFZA-16, Office 512, P.O.Box 17328,  
Jebel Ali FZE, Dubai, UAE  
Tel: +971-4-801-1500

### ASIA

#### THE PEOPLE'S REPUBLIC OF CHINA

**Yamaha Music & Electronics (China) Co.,Ltd.**  
2F, Yunhedasha, 1818 Xinzha-lu, Jingan-qu,  
Shanghai, China  
Tel: +86-400-051-7700

#### INDIA

**Yamaha Music India Private Limited**  
P-401, JMD Megapolis, Sector-48, Sohna Road,  
Gurugram-122018, Haryana, India  
Tel: +91-124-485-3300

#### INDONESIA

**PT Yamaha Musik Indonesia Distributor**  
Yamaha Music Center Bldg. Jalan Jend. Gatot  
Subroto Kav. 4, Jakarta 12930, Indonesia  
Tel: +62-21-520-2577

#### KOREA

**Yamaha Music Korea Ltd.**  
11F, Prudential Tower, 298, Gangnam-daero,  
Gangnam-gu, Seoul, 06253, Korea  
Tel: +82-2-3467-3300

#### MALAYSIA

**Yamaha Music (Malaysia) Sdn. Bhd.**  
No.8, Jalan Perbandaran, Kelana Jaya, 47301  
Petaling Jaya, Selangor, Malaysia  
Tel: +60-3-78030900

#### SINGAPORE

**Yamaha Music (Asia) Private Limited**  
Block 202 Hougang Street 21, #02-00,  
Singapore 530202, Singapore  
Tel: +65-6740-9200

#### TAIWAN

**Yamaha Music & Electronics Taiwan Co.,Ltd.**  
2F., No.1, Yuandong Rd., Banqiao Dist.,  
New Taipei City 22063, Taiwan (R.O.C.)  
Tel: +886-2-7741-8888

#### THAILAND

**Siam Music Yamaha Co., Ltd.**  
3, 4, 15, 16th Fl., Siam Motors Building,  
891/1 Rama 1 Road, Wangmai,  
Pathumwan, Bangkok 10330, Thailand  
Tel: +66-2215-2622

#### VIETNAM

**Yamaha Music Vietnam Company Limited**  
15th Floor, Nam A Bank Tower, 201-203 Cach  
Mang Thang Tam St., Ward 4, Dist.3,  
Ho Chi Minh City, Vietnam  
Tel: +84-8-3818-1122

#### OTHER ASIAN REGIONS

<http://asia.yamaha.com/>

### OCEANIA

#### AUSTRALIA

**Yamaha Music Australia Pty. Ltd.**  
Level 1, 80 Market Street, South Melbourne,  
VIC 3205, Australia  
Tel: +61-3-9693-5111

#### REGIONS AND TRUST TERRITORIES IN PACIFIC OCEAN

<http://asia.yamaha.com/>

雅马哈乐器音响（中国）投资有限公司

上海市静安区新闻路 1818 号云和大厦 2 楼

客户服务热线：4000517700

公司网址：<https://www.yamaha.com.cn>

制造商：雅马哈株式会社

制造商地址：日本静冈县滨松市中区中泽町 10-1

厂名：伟易达（东莞）电讯有限公司

厂址：中国广东省东莞市寮步下岭贝工业区

台灣山葉音樂股份有限公司

YAMAHA MUSIC & ELECTRONICS TAIWAN CO., LTD.

<https://tw.yamaha.com>

總公司：(02) 7741-8888 新北市板橋區遠東路 1 號 2 樓

客服專線：0809-091388

ヤマハ株式会社

〒430-8650 静岡県浜松市中区中沢町 10-1

Yamaha Pro Audio global website  
<https://www.yamahaproaudio.com/>  
Yamaha Downloads  
<https://download.yamaha.com/>

© 2022 Yamaha Corporation  
Published 12/2022  
2022年12月 发行  
MWOD-A0

VEY7230